

The Garmin logo, consisting of the word "GARMIN" in a bold, sans-serif font with a registered trademark symbol, and a small white triangle pointing upwards to the right of the text.

G1000[®] Integrated Flight Deck Pilot's Guide

The Cessna Nav III logo, featuring the text "Cessna Nav III" in a bold, sans-serif font. The background of the logo is a detailed, grayscale aeronautical chart showing various airports, flight paths, and navigational data.

SYSTEM OVERVIEW

FLIGHT INSTRUMENTS

EIS

AUDIO PANEL & CNS

FLIGHT MANAGEMENT

HAZARD AVOIDANCE

AFCS

ADDITIONAL FEATURES

APPENDICES

INDEX

Copyright © 2004-2011 Garmin Ltd. or its subsidiaries. All rights reserved.

This manual reflects the operation of System Software version 0563.25 or later for Cessna 172R, 172S, 182T, T182T, 206H, and T206H aircraft. Some differences in operation may be observed when comparing the information in this manual to earlier or later software versions.



NOTE: *Cessna Nav III aircraft include the Cessna 172R, the Cessna 172S, the normally aspirated Cessna 182 (182), the turbocharged Cessna 182 (T182), the normally aspirated Cessna 206 (206), and the turbocharged Cessna 206 (T206). Unless otherwise indicated, information in the G1000 Cockpit Reference Guide pertains to all Cessna Nav III aircraft.*

Garmin International, Inc., 1200 East 151st Street, Olathe, Kansas 66062, U.S.A.
Tel: 913/397.8200 Fax: 913/397.8282

Garmin AT, Inc., 2345 Turner Road SE, Salem, OR 97302, U.S.A.
Tel: 503/391.3411 Fax 503/364.2138

Garmin (Europe) Ltd, Liberty House, Bulls Copse Road, Hounslow Business Park, Southampton, SO40 9RB, U.K.
Tel: 44/0870.8501241 Fax: 44/0870.8501251

Garmin Corporation, No. 68, Jangshu 2nd Road, Shijr, Taipei County, Taiwan
Tel: 886/02.2642.9199 Fax: 886/02.2642.9099

For after-hours emergency, aircraft on ground (AOG) technical support for Garmin panel mount and integrated avionics systems, please contact Garmin's AOG Hotline at 913.397.0836.

Web Site Address: www.garmin.com

Except as expressly provided herein, no part of this manual may be reproduced, copied, transmitted, disseminated, downloaded or stored in any storage medium, for any purpose without the express written permission of Garmin. Garmin hereby grants permission to download a single copy of this manual and of any revision to this manual onto a hard drive or other electronic storage medium to be viewed for personal use, provided that such electronic or printed copy of this manual or revision must contain the complete text of this copyright notice and provided further that any unauthorized commercial distribution of this manual or any revision hereto is strictly prohibited.

Garmin® and G1000® are registered trademarks of Garmin Ltd. or its subsidiaries. FliteCharts®, and SafeTaxi® are trademarks of Garmin Ltd. or its subsidiaries. These trademarks may not be used without the express permission of Garmin.

NavData® is a registered trademark of Jeppesen, Inc.; Stormscope® is a registered trademark of L-3 Communications; and XM® is a registered trademark of XM Satellite Radio, Inc.; Honeywell® and Bendix/King® are registered trademarks of Honeywell International, Inc.; CO Guardian is a trademark of CO Guardian, Inc.

LIMITED WARRANTY

Within the warranty period, Garmin will, at its sole discretion, repair or replace any components that fail in normal use. Such repairs or replacement will be made at no charge to the customer for parts and/or labor incidental to the direct repair of said product. Garmin may, at its discretion with prior approval, reimburse an authorized Garmin Service Center for associated labor costs incurred for removal and replacement of the panel mount product installed in an aircraft. The customer shall be responsible for any transportation or other cost. This warranty does not apply to: (i) cosmetic damage, such as scratches, nicks and dents; (ii) consumable parts, such as batteries, unless product damage has occurred due to a defect in materials or workmanship; (iii) damage caused by accident, abuse, misuse, water, flood, fire, or other acts of nature or external causes; (iv) damage caused by service performed by anyone who is not an authorized service provider of Garmin; or (v) damage to a product that has been modified or altered without the written permission of Garmin. In addition, Garmin reserves the right to refuse warranty claims against products or services that are obtained and/or used in contravention of the laws of any country.

THE WARRANTIES AND REMEDIES CONTAINED HEREIN ARE EXCLUSIVE AND IN LIEU OF ALL OTHER WARRANTIES, WHETHER EXPRESS, IMPLIED OR STATUTORY, INCLUDING ANY LIABILITY ARISING UNDER ANY WARRANTY OF MERCHANTABILITY OR FITNESS FOR A PARTICULAR PURPOSE, STATUTORY OR OTHERWISE. THIS WARRANTY GIVES YOU SPECIFIC LEGAL RIGHTS, WHICH MAY VARY FROM STATE TO STATE.

IN NO EVENT SHALL GARMIN BE LIABLE FOR ANY INCIDENTAL, SPECIAL, INDIRECT OR CONSEQUENTIAL DAMAGES, WHETHER RESULTING FROM THE USE, MISUSE, OR INABILITY TO USE THIS PRODUCT OR FROM DEFECTS IN THE PRODUCT. Some states do not allow the exclusion of incidental or consequential damages, so the above limitations may not apply in every case.

Garmin retains the exclusive right to repair or replace (with a new or newly-overhauled replacement product) the product or offer a full refund of the purchase price at its sole discretion. SUCH REMEDY SHALL BE YOUR SOLE AND EXCLUSIVE REMEDY FOR ANY BREACH OF WARRANTY.

To obtain warranty service, contact your local Garmin Authorized Service Center. For assistance in locating the nearest Service Center, call Garmin Customer Service at one of the numbers listed below.

Products sold through online auctions are not eligible for warranty coverage or rebates or other special offers from Garmin. Online auction confirmations are not accepted for warranty verification. To obtain warranty service, an original or copy of the sales receipt from the original retailer is required. Garmin will not replace missing components from any package purchased through an online auction.

Garmin International Inc.
1200 East 151st Street, Olathe, Kansas 66062
Telephone: (913)397-8200
Telephone Toll Free: (888)606-5482
Facsimile: (913)397-8282
Facsimile Toll Free: (800)801-4670
E-mail: orders@garmin.com
avionics@garmin.com
warranty@garmin.com

Garmin (Europe) Ltd.
Liberty House, Bulls Copse Road, Southampton, SO40
9RB, UK
Telephone: ++44 (0) 870-8501243
Telephone Toll Free: ++44 (0) 0808 238 0000
(option 5)
Facsimile: ++44 (0) 238052004
E-mail: avionics.europe@garmin.com

 **WARNING:** Navigation and terrain separation must NOT be predicated upon the use of the terrain avoidance feature. The terrain avoidance feature is NOT intended to be used as a primary reference for terrain avoidance and does not relieve the pilot from the responsibility of being aware of surroundings during flight. The terrain avoidance feature is only to be used as an aid for terrain avoidance. Terrain data is obtained from third party sources. Garmin is not able to independently verify the accuracy of the terrain data.

 **WARNING:** The displayed minimum safe altitudes (MSAs) are only advisory in nature and should not be relied upon as the sole source of obstacle and terrain avoidance information. Always refer to current aeronautical charts for appropriate minimum clearance altitudes.

 **WARNING:** The altitude calculated by G1000 GPS receivers is geometric height above Mean Sea Level and could vary significantly from the altitude displayed by pressure altimeters, such as the GDC 74A Air Data Computer, or other altimeters in aircraft. GPS altitude should never be used for vertical navigation. Always use pressure altitude displayed by the G1000 PFD or other pressure altimeters in aircraft.

 **WARNING:** Do not use outdated database information. Databases used in the G1000 system must be updated regularly in order to ensure that the information remains current. Pilots using any outdated database do so entirely at their own risk.

 **WARNING:** Do not use basemap (land and water data) information for primary navigation. Basemap data is intended only to supplement other approved navigation data sources and should be considered as an aid to enhance situational awareness.

 **WARNING:** Traffic information shown on system displays is provided as an aid in visually acquiring traffic. Pilots must maneuver the aircraft based only upon ATC guidance or positive visual acquisition of conflicting traffic.

 **WARNING:** Use of the Stormscope is not intended for hazardous weather penetration (thunderstorm penetration). Stormscope information, as displayed on the G1000 MFD, is to be used only for weather avoidance, not penetration.

 **WARNING:** Do not use datalink weather products (e.g., XM WX Satellite Weather, GFDS World Wide Weather, or FIS-B) for hazardous weather penetration. Weather information provided by these products is aged by up to several minutes and may not depict actual weather conditions as they currently appear.

 **WARNING:** NEXRAD weather data is to be used for long-range planning purposes only. Due to inherent delays in data transmission and the relative age of the data, NEXRAD weather data should not be used for short-range weather avoidance.



WARNING: For safety reasons, G1000 operational procedures must be learned on the ground.



WARNING: The Garmin G1000, as installed in Cessna Nav III aircraft, has a very high degree of functional integrity. However, the pilot must recognize that providing monitoring and/or self-test capability for all conceivable system failures is not practical. Although unlikely, it may be possible for erroneous operation to occur without a fault indication shown by the G1000. It is thus the responsibility of the pilot to detect such an occurrence by means of cross-checking with all redundant or correlated information available in the cockpit.



WARNING: The United States government operates the Global Positioning System and is solely responsible for its accuracy and maintenance. The GPS system is subject to changes which could affect the accuracy and performance of all GPS equipment. Portions of the Garmin G1000 utilize GPS as a precision electronic NAVigation AID (NAVAID). Therefore, as with all NAVAIDs, information presented by the G1000 can be misused or misinterpreted and, therefore, become unsafe.



WARNING: To reduce the risk of unsafe operation, carefully review and understand all aspects of the G1000 Pilot's Guide documentation. Thoroughly practice basic operation prior to actual use. During flight operations, carefully compare indications from the G1000 to all available navigation sources, including the information from other NAVAIDs, visual sightings, charts, etc. For safety purposes, always resolve any discrepancies before continuing navigation.



WARNING: The illustrations in this guide are only examples. Never use the G1000 to attempt to penetrate a thunderstorm. Both the FAA Advisory Circular, Subject: Thunderstorms, and the Airman's Information Manual (AIM) recommend avoiding "by at least 20 miles any thunderstorm identified as severe or giving an intense radar echo."



WARNING: Because of variation in the earth's magnetic field, operating the system within the following areas could result in loss of reliable attitude and heading indications. North of 72° North latitude at all longitudes. South of 70° South latitude at all longitudes. North of 65° North latitude between longitude 75° W and 120° W. (Northern Canada). North of 70° North latitude between longitude 70° W and 128° W. (Northern Canada). North of 70° North latitude between longitude 85° E and 114° E. (Northern Russia). South of 55° South latitude between longitude 120° E and 165° E. (Region south of Australia and New Zealand).



WARNING: Do not use GPS to navigate to any active waypoint identified as a 'NON WGS84 WPT' by a system message. 'NON WGS84 WPT' waypoints are derived from an unknown map reference datum that may be incompatible with the map reference datum used by GPS (known as WGS84) and may be positioned in error as displayed.



CAUTION: The PFD and MFD displays use a lens coated with a special anti-reflective coating that is very sensitive to skin oils, waxes, and abrasive cleaners. **CLEANERS CONTAINING AMMONIA WILL HARM THE ANTI-REFLECTIVE COATING.** It is very important to clean the lens using a clean, lint-free cloth and an eyeglass lens cleaner that is specified as safe for anti-reflective coatings.



CAUTION: The Garmin G1000 does not contain any user-serviceable parts. Repairs should only be made by an authorized Garmin service center. Unauthorized repairs or modifications could void both the warranty and the pilot's authority to operate this device under FAA/FCC regulations.



NOTE: When using Stormscope, there are several atmospheric phenomena in addition to nearby thunderstorms that can cause isolated discharge points in the strike display mode. However, clusters of two or more discharge points in the strike display mode do indicate thunderstorm activity if these points reappear after the screen has been cleared.



NOTE: Interference from GPS repeaters operating inside nearby hangars can cause an intermittent loss of attitude and heading displays while the aircraft is on the ground. Moving the aircraft more than 100 yards away from the source of the interference should alleviate the condition.



NOTE: All visual depictions contained within this document, including screen images of the G1000 panel and displays, are subject to change and may not reflect the most current G1000 system and aviation databases. Depictions of equipment may differ slightly from the actual equipment.



NOTE: This device complies with part 15 of the FCC Rules. Operation is subject to the following two conditions: (1) this device may not cause harmful interference, and (2) this device must accept any interference received, including interference that may cause undesired operation.



NOTE: The GDU 1040 PFD/MFD may require a warm-up time of up to 30 minutes when exposed to -40°C for an extended period. A warm-up time of up to 15 minutes may be required when exposed to -30°C for an extended period.



NOTE: This product, its packaging, and its components contain chemicals known to the State of California to cause cancer, birth defects, or reproductive harm. This notice is being provided in accordance with California's Proposition 65. If you have any questions or would like additional information, please refer to our web site at www.garmin.com/prop65.



NOTE: Use of polarized eyewear may cause the flight displays to appear dim or blank.

Record of Revisions				
Part Number	Revision	Date	Page Range	Description
190-00498-00	A	10/27/05	i - I-4	Reformatted for single part number (all previous part numbers incorporated into this part number) Added TAWS-B Added CO Guardian Added new fuel totalizer
190-00498-01	A	9/11/06	i - I-6	Added GFC 700 AFCS Added WAAS and VNAV Added Chartview, Flitecharts, and SafeTaxi Added GDU 7.00 parameters Change manual to larger format
190-00498-02	A	3/8/07	i - I-6	Added Airways Added ADS-B Added GDU 8.02 parameters Various clerical changes
190-00498-03	A	11/6/07	i - I-6	Added GDU 8.20 parameters, including gradient background on the PFD and GFC 700 for the C172.
190-00498-04	A	9/26/08	All	Added GDU 9.03 parameters Removed gradient background. Added Synthetic Vision System
190-00498-05	A	8/14/09	All	Added GDU 9.14 Added new page navigation Added flight plan import/export Added new EIS displays Added CDI use in Dead Reckoning Mode Various clerical changes
190-00498-06	A	1/10	All	Added GDU 10.01 Added Auxiliary Video Added AOPA Airport Directory Added Flight Data Logging
	B	4/10	484	Removed statement regarding certain SD cards voiding the G1000 warranty.
190-00498-07	A	10/11	All	Added Profile View Added FIS-B Weather Added Arrival Alert Added GTS 800 Traffic System Updated database synchronization Added GDU 12.02 parameters

BLANK PAGE

SECTION 1 SYSTEM OVERVIEW		2.4 Abnormal Operations 78
1.1 System Description 1		Abnormal GPS Conditions 78
1.2 Line Replaceable Units (LRU) 2		Unusual Attitudes 79
1.3 G1000 Controls 7		SECTION 3 ENGINE INDICATION SYSTEM (EIS)
PFD/MFD Controls 7		3.1 Engine Display 83
Audio Panel Controls 10		Normally-Aspirated and Turbocharged Aircraft 83
1.4 Secure Digital (SD) Cards 12		3.2 Lean Display 86
1.5 System Power-up 13		Normally-Aspirated Aircraft 88
1.6 System Operation 14		Turbocharged Aircraft 89
Normal Display Operation 14		3.3 System Display 90
Reversionary Display Operation 14		Normally-Aspirated and Turbocharged Aircraft 90
AHRS Operation 15		SECTION 4 AUDIO PANEL AND CNS
G1000 System Annunciations 17		4.1 Overview 95
Softkey Function 17		MFD/PFD Controls and Frequency Display 96
GPS Receiver Operation 25		Audio Panel Controls 98
1.7 Accessing G1000 Functionality 29		4.2 COM Operation 100
Menus 29		COM Transceiver Selection and Activation 100
MFD Page Groups 30		COM Transceiver Manual Tuning 101
MFD System Pages 34		Quick-tuning and Activating 121.500 MHz 102
1.8 Display Backlighting 44		Auto-tuning the COM Frequency 103
Automatic Adjustment 44		Frequency Spacing 107
Manual Adjustment 44		Automatic Squelch 108
		Volume 108
SECTION 2 FLIGHT INSTRUMENTS		4.3 NAV Operation 109
2.1 Flight Instruments 50		NAV Radio Selection and Activation 109
Airspeed Indicator 50		NAV Receiver Manual Tuning 110
Attitude Indicator 52		Auto-tuning a NAV Frequency from the MFD 112
Altimeter 53		Marker Beacon Receiver 117
Vertical Speed Indicator (VSI) 55		DME Tuning 118
Horizontal Situation Indicator (HSI) 57		4.4 GTX 33 Mode S Transponder 119
Course Deviation Indicator (CDI) 62		Transponder Controls 119
2.2 Supplemental Flight Data 69		Transponder Mode Selection 120
Outside Air Temperature 69		Entering a Transponder Code 123
Wind Data 71		IDENT Function 124
Vertical Navigation (VNV) Indications 72		4.5 Additional Audio Panel Functions 125
2.3 PFD Annunciations and Alerting Functions 73		Power-up 125
System Alerting 73		Mono/Stereo Headsets 125
Marker Beacon Annunciations 74		Speaker 125
Traffic Annunciation 74		Intercom 126
TAWS Annunciations 75		Passenger Address (PA) System 128
Altitude Alerting 76		Clearance Recorder and Player 128
Low Altitude Annunciation 76		Entertainment Inputs 129
Minimum Descent Altitude/Decision Height Alerting 77		

4.6 Audio Panel Preflight Procedure 130

4.7 Abnormal Operation 131

 Stuck Microphone..... 131

 COM Tuning Failure..... 131

 Audio Panel Fail-safe Operation 131

 Reversionary Mode..... 131

SECTION 5 FLIGHT MANAGEMENT

5.1 Introduction 133

 Navigation Status Box..... 134

5.2 Using Map Displays..... 136

 Map Orientation..... 136

 Map Range 138

 Map Panning..... 140

 Measuring Bearing and Distance..... 144

 Topography..... 145

 Map Symbols 148

 Airways 154

 Track Vector 156

 Wind Vector 157

 Nav Range Ring..... 158

 Fuel Range Ring 159

 Field of View (SVS)..... 160

 Selected Altitude Intercept Arc..... 161

5.3 Waypoints..... 162

 Airports 163

 Intersections 170

 NDBs..... 172

 VORs..... 174

 User Waypoints 176

5.4 Airspaces 182

5.5 Direct-to-Navigation 185

5.6 Flight Planning..... 190

 Flight Plan Creation 191

 Adding Waypoints to an Existing Flight Plan..... 196

 Adding Airways to a Flight Plan 198

 Adding Procedures to a Stored Flight Plan 201

 Flight Plan Storage 207

 Flight Plan Editing 210

 Along Track Offsets..... 214

 Parallel Track 215

 Activating a Flight Plan Leg 218

 Inverting a Flight Plan 219

 Flight Plan Views 220

 Closest Point of FPL 222

5.7 Vertical Navigation 223

 Altitude Constraints..... 225

5.8 Procedures 229

 Departures..... 229

 Arrivals 232

 Approaches 234

5.9 Trip Planning 240

 Trip Planning..... 240

5.10 RAIM Prediction..... 244

5.11 Navigating a Flight Plan..... 247

5.12 Abnormal Operation 275

SECTION 6 HAZARD AVOIDANCE

6.1 XM WX Satellite Weather 278

 Activating Services..... 278

 Using XM WX Satellite Weather Products..... 279

6.2 GFDS Worldwide Weather 312

 Registering the Iridium Satellite System 312

 Registering the system for Garmin Flight Data Services..... 313

 GFDS Weather Data Requests 322

 Worldwide Weather Products..... 326

 Abnormal Operations..... 342

6.3 FIS-B Weather 344

 Using FIS-B Weather Products..... 344

6.4 WX-500 Stormscope 359

 Setting Up Stormscope on the Navigation Map 359

6.5 Terrain Proximity 364

 Displaying Terrain Proximity Data..... 364

6.6 Profile View Terrain 369

 Profile View Display 369

6.7 Terrain-SVS 372

 Displaying Terrain-SVS Data..... 373

 Terrain-SVS Page 375

 Terrain-SVS Alerts 377

6.8 TAWS-B 381

 Displaying TAWS-B Data..... 382

 TAWS-B Page 385

 TAWS-B Alerts 387

 System Status..... 392

6.9 Traffic Information Service (TIS)	394	7.5 Autopilot Operation	459
Displaying TRAFFIC Data	395	Engaging the Autopilot	459
Traffic Map Page.....	397	Control Wheel Steering	460
TIS Alerts	398	Disengaging the Autopilot.....	460
System Status.....	399	7.6 Example Procedures	461
6.10 Garmin GTS 800 Traffic	402	Departure	462
Theory of operation	402	Intercepting a VOR Radial.....	464
TAS Alerts	405	Flying a Flight Plan/GPS Course	465
System Test.....	406	Descent	466
Operation	407	Approach.....	470
6.11 Honeywell KTA870 Traffic	415	Go Around/Missed Approach	474
TAS Symbology.....	415	7.7 AFCS Annunciations and Alerts	476
Operation	416	AFCS Status Alerts	476
Altitude Display.....	419	Overspeed Protection.....	477
Traffic Map Page Display Range	419		
TAS Alerts	421		
System Status.....	422		
6.12 ADS-B Traffic	423		

SECTION 7 AUTOMATIC FLIGHT CONTROL SYSTEM

7.1 AFCS Controls	430	8.1 Synthetic Vision System (SVS) (Optional)	480
7.2 Flight Director Operation	432	SVS Operation.....	481
Activating the Flight Director	432	SVS Features	483
AFCS Status Box.....	433	Field of View	491
Command Bars.....	434	8.2 SafeTaxi	493
Flight Director Modes.....	434	SafeTaxi Cycle Number and Revision	496
7.3 Vertical Modes	435	8.3 ChartView (Optional)	499
Pitch Hold Mode (PIT)	436	ChartView Softkeys.....	499
Selected Altitude Capture Mode (ALTS).....	437	Terminal Procedures Charts	500
Altitude Hold Mode (ALT)	438	Chart Options.....	508
Vertical Speed Mode (VS)	439	Day/Night View	514
Flight Level Change Mode (FLC).....	440	ChartView Cycle Number and Expiration Date.....	516
Vertical Navigation Modes (VPTH, ALTV).....	442	8.4 FliteCharts	519
Glidepath Mode (GP) (SBAS Only).....	447	FliteCharts Softkeys	519
Glideslope Mode (GS)	449	Terminal Procedures Charts	520
Go Around Mode (GA)	450	Chart Options.....	527
7.4 Lateral Modes	451	Day/Night View	531
Roll Hold Mode (ROL)	452	FliteCharts Cycle Number and Expiration Date.....	533
Heading Select Mode (HDG)	453	8.5 AOPA Airport Directory	536
Navigation Modes (GPS, VOR, LOC)	454	AOPA Database Cycle Number and Revision	537
Approach Modes (GPS, VAPP, LOC)	456	8.6 SiriusXM Satellite Radio (Service Optional)	539
Backcourse Mode (BC)	458	Activating SiriusXM Satellite Radio Services	539
		Using SiriusXM Radio.....	540
		Automatic Audio Muting	544
		8.7 Scheduler	545
		8.8 Electronic Checklists	547

SECTION 8 ADDITIONAL FEATURES

8.9 Flight Data Logging 550

8.10 Auxiliary Video (Optional) 552

 Video Setup 553

 Display Selection 553

 Input Selection 554

 Zoom/Range 554

8.11 Abnormal Operation 556

 SVS Troubleshooting 556

 Reversionary Mode 556

 Unusual Attitudes 557

APPENDICES

Annunciations and Alerts 561

 Alert Level Definitions 562

 Nav III Aircraft Alerts 562

 CO Guardian Messages 563

 G1000 System Annunciations 563

 Other G1000 Aural Alerts 566

 G1000 System Message Advisories 566

 Flight Plan Import/Export Messages 577

 AFCS Alerts 578

 Terrain-SVS Alerts 579

 TAWS-B ALERTS 580

 TAWS-B System Status Annunciations 581

Database Management 583

 Jeppesen Databases 583

 Garmin Databases 587

Glossary 593

Frequently Asked Questions 599

General TIS Information 603

 Introduction 603

 TIS vs. TAS/TCAS 603

 TIS Limitations 603

Map Symbols 605

INDEX

Index I-1

SECTION 1 SYSTEM OVERVIEW

1.1 SYSTEM DESCRIPTION

This section is designed to provide an overview of the G1000 Integrated Flight Deck as installed in Cessna Nav III aircraft, which include the Cessna 172R, 172S, the normally aspirated Cessna 182 (182), the turbocharged Cessna 182 (T182), the normally aspirated Cessna 206 (206), and the turbocharged Cessna 206 (T206).

The G1000 system is an integrated flight control system that presents flight instrumentation, position, navigation, communication, and identification information to the pilot through large-format displays. The system consists of the following Line Replaceable Units (LRUs):

- **GDU 1040/1044B** Primary Flight Display (PFD)
- **GDU 1040/1044B** Multi Function Display (MFD)
- **GIA 63/63W** Integrated Avionics Unit (IAU)
- **GDC 74A** Air Data Computer (ADC)
- **GEA 71** Engine/Airframe Unit
- **GRS 77** Attitude and Heading Reference System (AHRS)
- **GMU 44** Magnetometer
- **GMA 1347** Audio System with Integrated Marker Beacon Receiver
- **GTX 33** Mode S Transponder
- **GDL 69A** Satellite Data Link Receiver
- **GTS 800** Traffic Avoidance System (optional)
- **GDL 90** ADS-B/FIS-B Data Link Transceiver (optional)
- **GSA 81** AFCS Servos
- **GSM 85** Servo Gearboxes

A top-level G1000 system block diagram is shown in Figure 1-1. See Figure 1-2 for optional/additional equipment.



NOTE: Refer to the AFCS section for details on the GFC 700 AFCS.

The GFC 700 Automated Flight Control System (AFCS) provides the flight director (FD) and autopilot (AP) functions of the G1000 system.

1.2 LINE REPLACEABLE UNITS (LRU)

- **GDU 1040/1044B** – The GDU 1044B features a 10.4-inch LCD display with 1024 x 768 resolution. The left display is configured as a PFD and the right display is configured as an MFD. Both GDU 1044Bs link and display all functions of the G1000 system during flight. The displays communicate with each other through a High-Speed Data Bus (HSDB) Ethernet connection. Each display is also paired via an Ethernet connection with a GIA 63 or 63W Integrated Avionics Unit. Systems that do not use the GFC 700 Automatic Flight Control System use the GDU 1040, which employs the same features as the GDU 1044B without the controls for the Garmin GFC 700 Automatic Flight Control System (AFCS).



- **GIA 63/63W (2)** – Functions as the main communication hub, linking all LRUs with the PFD. Each GIA 63/63W contains a GPS receiver, VHF COM/NAV/GS receivers, a flight director (FD) and system integration microprocessors. The GIA 63W contains a GPS SBAS receiver. Each GIA is paired with a respective GDU 1040/1044B display through Ethernet. The GIAs are not paired together and do not communicate with each other directly.



- **GDC 74A (1)** – Processes data from the pitot/static system as well as the OAT probe. This unit provides pressure altitude, airspeed, vertical speed and OAT information to the G1000 system, and it communicates with the GIA 63/63W, GDU 1040/1044B, and GRS 77, using an ARINC 429 digital interface. The GDC 74A also interfaces directly with the GTP 59.



- **GEA 71** (1) – Receives and processes signals from the engine and airframe sensors. This unit communicates with both GIA 63/63Ws using an RS-485 digital interface.



- **GRS 77** (1) – Provides aircraft attitude and heading information via ARINC 429 to both the GDU 1040/1044B and the GIA 63/63W. The GRS 77 contains advanced sensors (including accelerometers and rate sensors) and interfaces with the on-side GMU 44 to obtain magnetic field information, with the GDC 74A to obtain air data, and with both GIAs to obtain GPS information. AHRS modes of operation are discussed later in this document.



- **GMU 44** (1) – Measures local magnetic field. Data is sent to the GRS 77 for processing to determine aircraft magnetic heading. This unit receives power directly from the GRS 77 and communicates with the GRS 77 using an RS-485 digital interface.



- **GMA 1347** – The GMA 1347 Audio Panel integrates NAV/COM digital audio, intercom system and marker beacon controls. The GMA 1347 also controls manual display reversionary mode (red **DISPLAY BACKUP** button) and is installed between the MFD and the PFD. The GMA 1347 communicates with both GIA 63/63Ws using an RS-232 digital interface.



- **GTX 33** (1) – The GTX 33 is a solid-state, Mode-S transponder that provides Modes A, C and S operation. The GTX 33 is controlled through the PFD and communicates with both GIA 63/63Ws through an RS-232 digital interface.



SYSTEM OVERVIEW

FLIGHT INSTRUMENTS

EIS

AUDIO PANEL & CNS

FLIGHT MANAGEMENT

HAZARD AVOIDANCE

AFCS

ADDITIONAL FEATURES

APPENDICES

INDEX

- SYSTEM OVERVIEW
- FLIGHT INSTRUMENTS
- EIS
- AUDIO PANEL & CNS
- FLIGHT MANAGEMENT
- HAZARD AVOIDANCE
- AFCS
- ADDITIONAL FEATURES
- APPENDICES
- INDEX

- **GDL 69A** (1) – A satellite radio receiver that provides real-time weather information to the G1000 MFD (and, indirectly, to the inset map of the PFD) as well as digital audio entertainment. The GDL 69A communicates with the MFD via HSDB connection. A subscription to the SiriusXM Satellite Radio service is required to enable the GDL 69A capability.



- **GTS 800** – The GTS 800 Traffic Advisory System (TAS) uses active interrogations of Mode S and Mode C transponders to provide Traffic Advisories to the pilot independent of the air traffic control system.



- **GDL 90** (1) – A digital data link transceiver designed to transmit, receive and decode ADS-B traffic information, as well as FIS-B weather information. It broadcasts aircraft position, velocity, projected track, altitude, and flight identification to other equipped aircraft in the vicinity, as well as to FAA ground stations. The GDL 90 receives FIS-B weather information which is displayed on the MFD as NEXRAD radar and METARs.



- **GSA 81** (3), and **GSM 85** (3) – The GSA 81 servos are used for the automatic control of roll, pitch, and pitch trim. These units interface with each GIA 63/63W.

The GSM 85 servo gearbox is responsible for transferring the output torque of the GSA 81 servo actuator to the mechanical flight-control surface linkage.



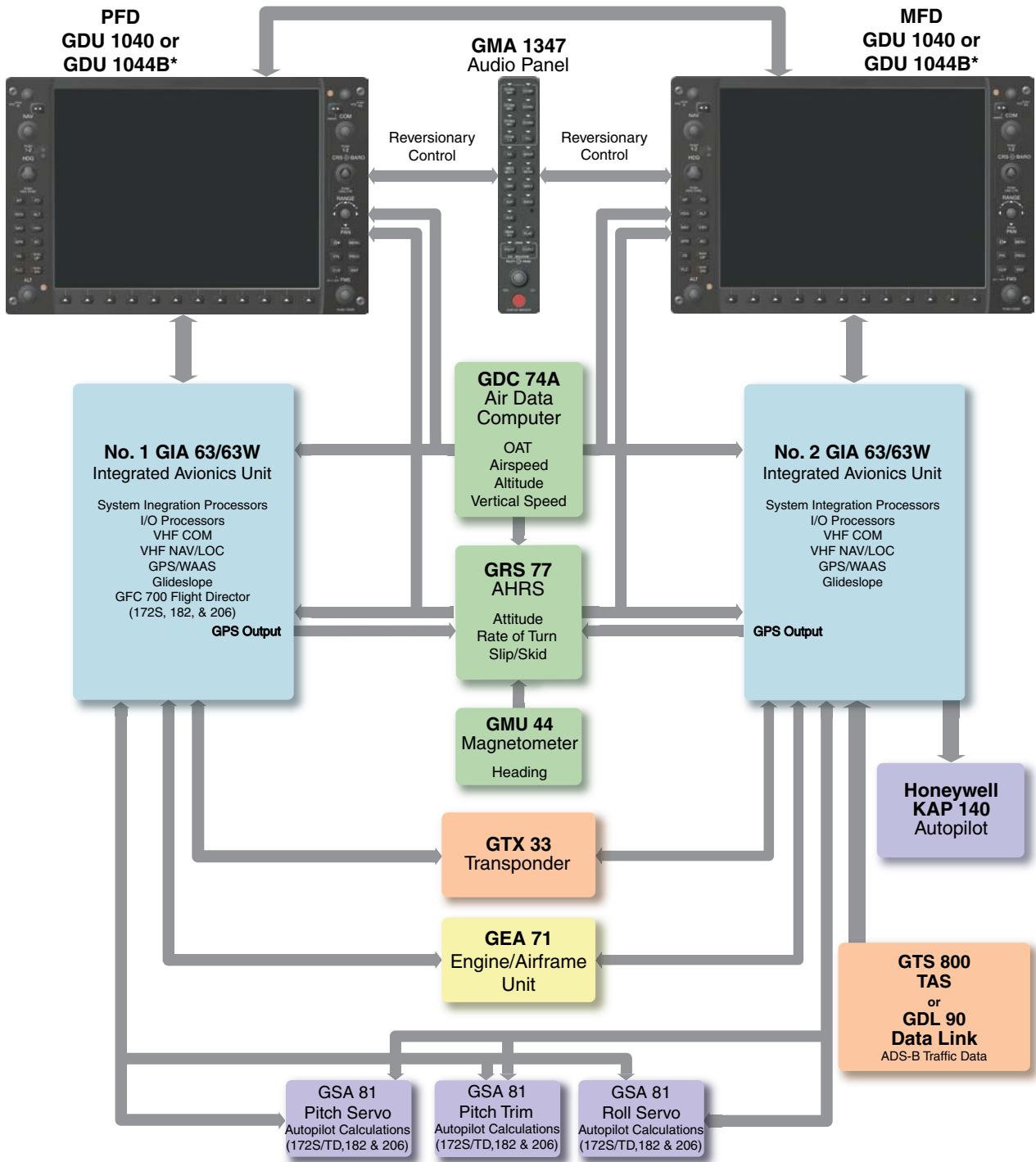

* The GDU 1040 is available in systems not using the GFC 700 Automatic Flight Control System. The GDU 1044B is available in systems using the Garmin GFC 700 Automatic Flight Control System.

Figure 1-1 Basic G1000 System

- SYSTEM OVERVIEW
- FLIGHT INSTRUMENTS
- EIS
- AUDIO PANEL & CNS
- FLIGHT MANAGEMENT
- HAZARD AVOIDANCE
- AFCS
- ADDITIONAL FEATURES
- APPENDICES
- INDEX

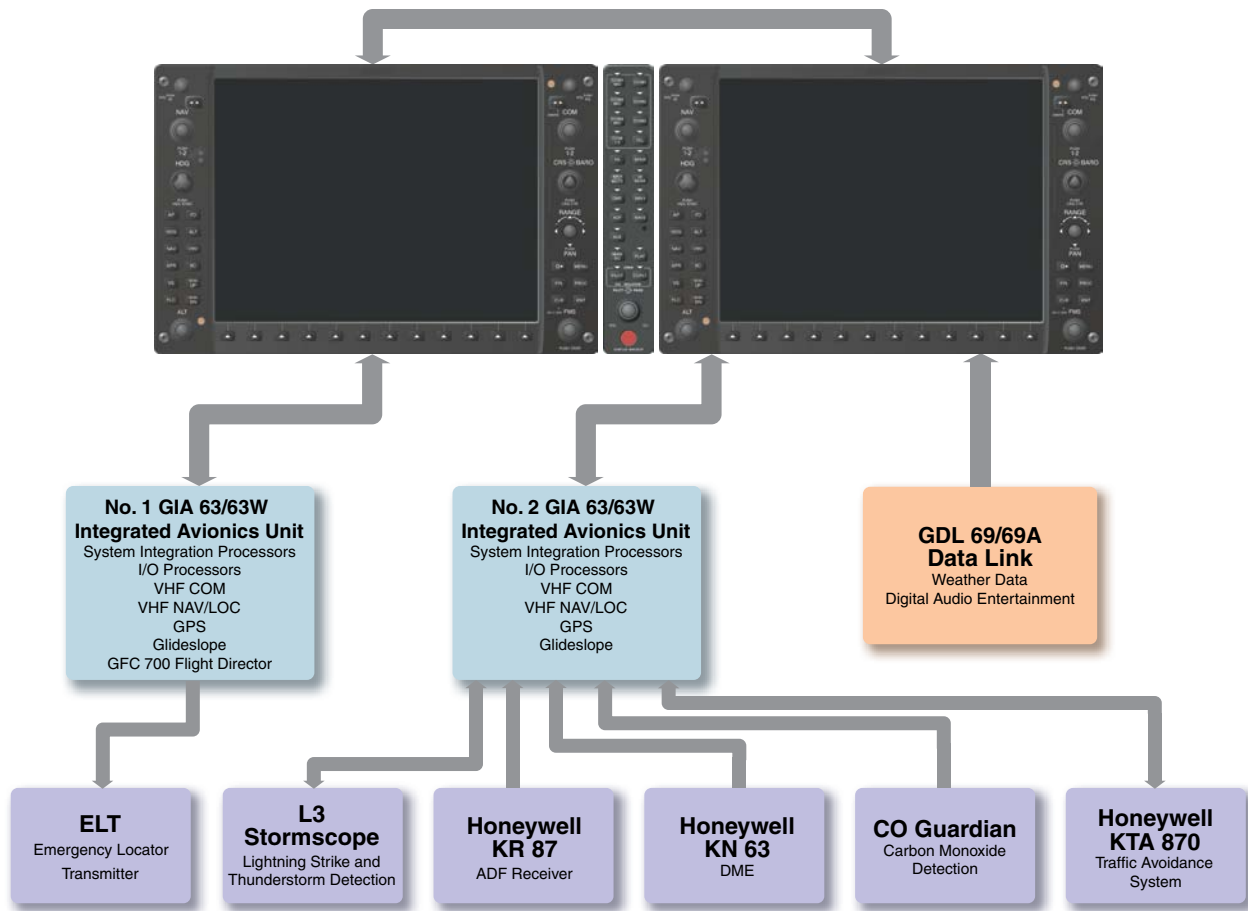

Figure 1-2 Additional Equipment Options

1.3 G1000 CONTROLS

NOTE: The Audio Panel (GMA 1347) and AFCS controls are described in the CNS & Audio Panel and AFCS sections respectively.

The G1000 system controls are located on the PFD and MFD bezels and audio panel. The controls for the PFD and MFD are discussed within the following pages of this section.

PFD/MFD CONTROLS

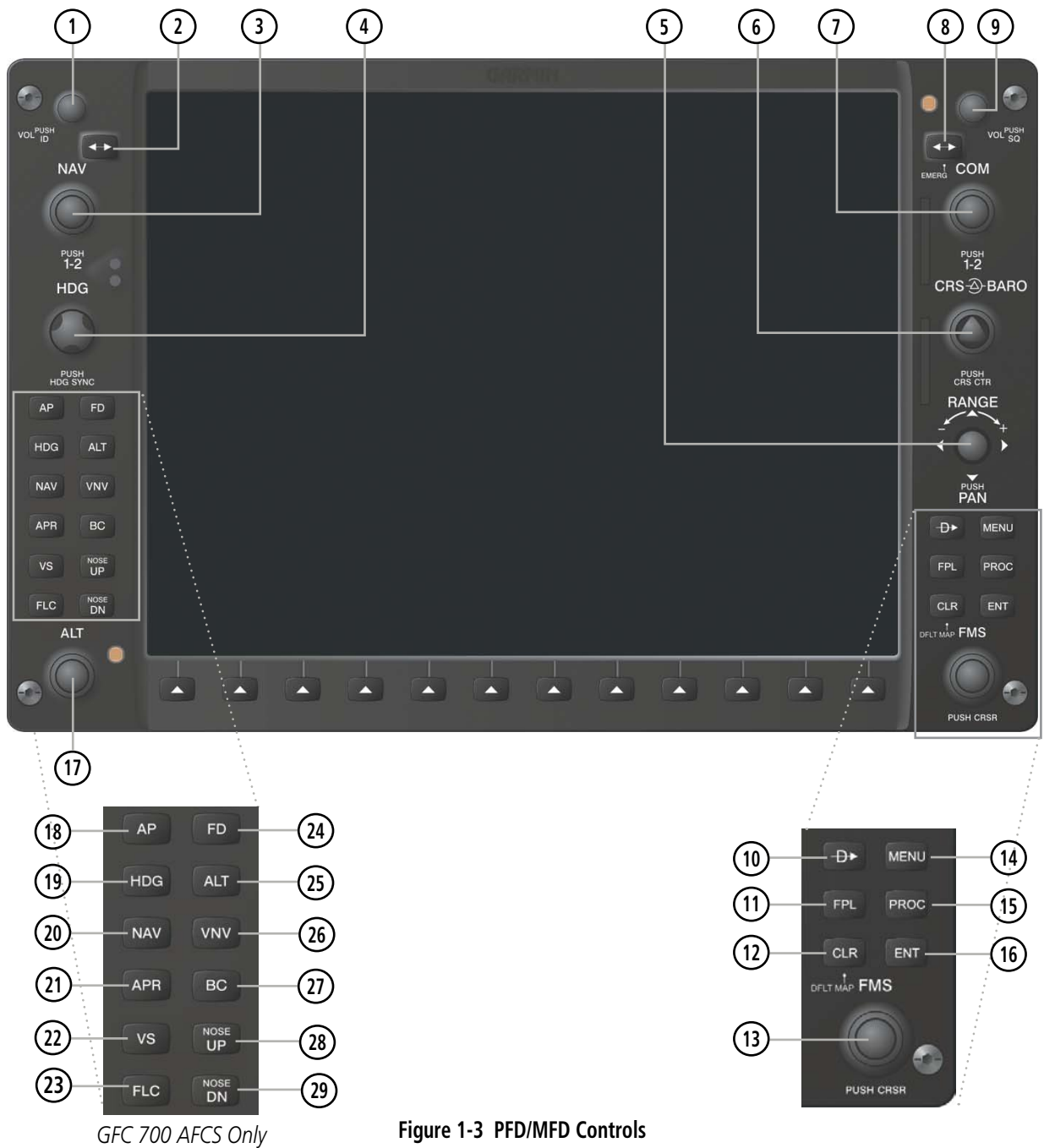

Figure 1-3 PFD/MFD Controls

PFD and MFD control functions are the same.

- ① **NAV VOL/ID Knob** – Controls the NAV audio level. Press to toggle the Morse code identifier ON and OFF. Volume level is shown in the field as a percentage.
- ② **NAV Frequency Transfer Key** – Transfers the standby and active NAV frequencies.
- ③ **Dual NAV Knob** – Tunes the MHz (large knob) and kHz (small knob) standby frequencies for the NAV receiver. Press to toggle the tuning cursor (light blue box) between the NAV1 and NAV2 fields.
- ④ **Heading Knob** – Turn to manually select a heading on the HSI. When pressed, it synchronizes the heading bug with the compass lubber line. Selected Heading provides the heading reference to the Flight Director while operating in Heading Select mode.
- ⑤ **Joystick** – Changes the map range (distance top to bottom of map display) when rotated. Activates the map pointer when pressed.
- ⑥ **CRS/BARO Knob** – The large knob sets the altimeter barometric pressure and the small knob adjusts the course. The course is only adjustable when the HSI is in VOR1, VOR2, or OBS/SUSP mode. Pressing this knob centers the CDI on the currently selected VOR. Selected Course provides course reference to the Flight Director when operating in Navigation and Approach modes.
- ⑦ **Dual COM Knob** – Tunes the MHz (large knob) and kHz (small knob) standby frequencies for the COM transceiver. Pressing this knob toggles the tuning cursor (light blue box) between the COM1 and COM2 fields.
- ⑧ **COM Frequency Transfer Key** – Transfers the standby and active COM frequencies. Pressing and holding this key for two seconds automatically tunes the emergency frequency (121.5 MHz) in the active frequency field.
- ⑨ **COM VOL/SQ Knob** – Controls COM audio level. Audio volume level is shown in the field as a percentage. Pressing this knob turns the COM automatic squelch ON and OFF.
- ⑩ **Direct-to Key** – Allows the user to enter a destination waypoint and establish a direct course to the selected destination (specified by the identifier, chosen from the active route, or taken from the map pointer position).
- ⑪ **FPL Key** – Displays the active Flight Plan Page for creating and editing the active flight plan, or for accessing stored flight plans.
- ⑫ **CLR Key (DFLT MAP)** – Erases information, cancels an entry, or removes page menus. To display the Navigation Map Page immediately, press and hold **CLR** (MFD only).
- ⑬ **Dual FMS Knob** – Press to turn the selection cursor ON/OFF.
 - Data Entry:** With the cursor ON, turn to enter data in the highlighted field (large knob moves cursor location; small knob selects character for highlighted cursor location). When the cursor is turned ON while viewing the Active Flight Plan Page, the cursor is placed on the line below the Data Insertion Pointer see Figure 1-4. The pointer indicates data entered at the cursor will be inserted above the line selected.
 - Scrolling:** When a list of information is too long for the window/box, a scroll bar appears, indicating more items to view. With cursor ON, turn large knob to scroll through the list.
 - Page Selection:** Turn knob on MFD to select the page to view (large knob selects a page group; small knob selects a specific page from the group)
- ⑭ **MENU Key** – Displays a context-sensitive list of options. This list allows the user to access additional features, or to make setting changes that relate to certain pages.

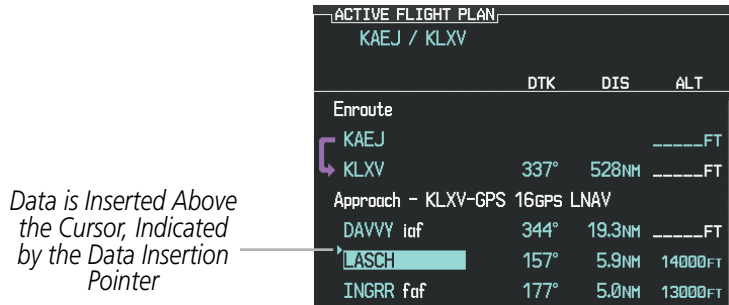

Figure 1-4 Data Insertion Pointer

- ⑮ **PROC Key** – Selects approaches, departures and arrivals from the flight plan. If a flight plan is used, available procedures for the departure and/or arrival airport are automatically suggested. If a flight plan is not used, the desired airport and the desired procedure may be selected. This key selects IFR departure procedures (DPs), arrival procedures (STARs) and approaches (IAPs) from the database and loads them into the active flight plan.
- ⑯ **ENT Key** – Accepts a menu selection or data entry. This key is used to approve an operation or complete data entry. It is also used to confirm selections and information entries.
- ⑰ **Dual ALT Knob** – Sets the selected altitude in the box located above the Altimeter. The large knob selects the thousands (500m for metric), while the small knob selects the hundreds (50m for metric). Altitude Select is used by the Automatic Flight Control System in certain modes, in addition to the standard G1000 Altitude Alerter function.

The following are only available with the GFC 700 AFCS.

- ⑱ **AP Key** – Engages/disengages the autopilot and flight director. Pressing the **AP** Key activates the flight director and engages the autopilot in the default pitch axis and roll axis modes. Pressing the **AP** Key again disengages the autopilot and deactivates the flight director.
- ⑲ **HDG Key** – Selects/deselects Heading Select Mode.
- ⑳ **NAV Key** – Selects/deselects Navigation Mode.
- ㉑ **APR Key** – Selects/deselects Approach Mode.
- ㉒ **VS Key** – Selects/deselects Vertical Speed Mode.
- ㉓ **FLC Key** – Selects/deselects Flight Level Change Mode.
- ㉔ **FD Key** – Activates/deactivates the flight director only. Pressing the **FD** Key turns on the flight director in the default pitch axis and roll axis modes. Pressing the **FD** Key again deactivates the flight director and removes the command bars, unless the autopilot is engaged. If the autopilot is engaged, the **FD** Key is disabled.
- ㉕ **ALT Key** – Selects/deselects Altitude Hold Mode.
- ㉖ **VNV Key** – Selects/deselects Vertical Navigation Mode.
- ㉗ **BC Key** – Selects/deselects Back Course Mode.
- ㉘ ㉙ **NOSE UP/NOSE DN Keys** – Controls the active pitch reference for the Pitch Hold, Vertical Speed, and Flight Level Change modes.

AUDIO PANEL CONTROLS

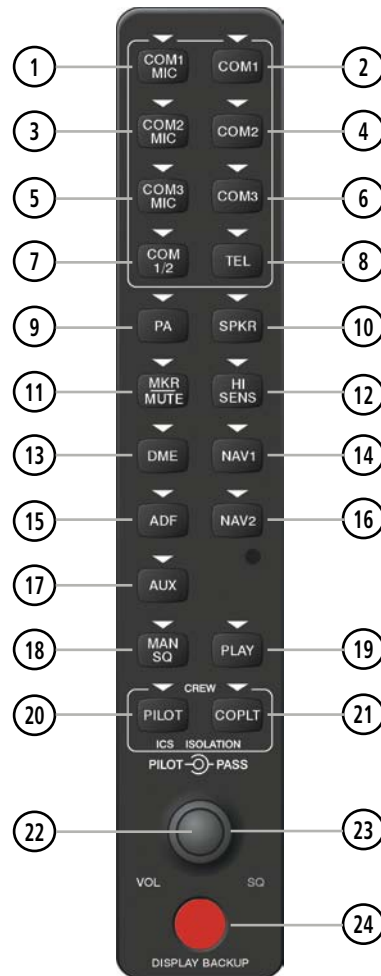

Figure 1-5 Audio Panel Controls (GMA 1347)

NOTE: When a key is selected, a triangular annunciator above the key is illuminated.

- ① **COM1 MIC** – Selects the #1 transmitter for transmitting. COM1 receive is simultaneously selected when this key is pressed allowing received audio from the #1 COM receiver to be heard. COM2 receiver audio can be added by pressing the **COM2** Key.
- ② **COM1** – When selected, audio from the #1 COM receiver can be heard.
- ③ **COM2 MIC** – Selects the #2 transmitter for transmitting. COM2 is simultaneously selected when this key is pressed allowing received audio from the #2 COM receiver to be heard. COM2 can be deselected by pressing the **COM2** Key, or COM1 can be added by pressing the **COM1** Key.
- ④ **COM2** – When selected, audio from the #2 COM receiver can be heard.
- ⑤ **COM3 MIC** – Not used on Cessna Nav III aircraft.

- ⑥ **COM3** – Not used on Cessna Nav III aircraft.
- ⑦ **COM 1/2** – Split COM is disabled on Cessna Nav III aircraft.
- ⑧ **TEL** – Not used on Cessna Nav III aircraft.
- ⑨ **PA** – Selects the Passenger Address system. The selected COM transmitter is deselected when the **PA** Key is pressed. The Passenger Address system is disabled on the Cessna 172R/S.
- ⑩ **SPKR** – Selects and deselects the cabin speaker. COM and NAV receiver audio can be heard on the speaker.
- ⑪ **MKR/MUTE** – Mutes the currently received marker beacon receiver audio. Unmutes when new marker beacon audio is received. Also, stops play of the clearance recorder.
- ⑫ **HI SENS** – Press to increase marker beacon receiver sensitivity. Press again to return to normal.
- ⑬ **DME** – Pressing turns DME audio on or off.
- ⑭ **NAV1** – When selected, audio from the #1 NAV receiver can be heard.
- ⑮ **ADF** – Pressing turns on or off the audio from the ADF receiver.
- ⑯ **NAV2** – When selected, audio from the #2 NAV receiver can be heard.
- ⑰ **AUX** – Not used on Cessna Nav III aircraft.
- ⑱ **MAN SQ** – Press to enable manual squelch for the intercom. When active, press the **PILOT** Knob to illuminate ‘SQ’. Turn the **PILOT/PASS** Knobs to adjust squelch.
- ⑲ **PLAY** – Press once to play the last recorded audio. Pressing the **PLAY** Key during play begins playing the previously recorded memory block. Each subsequent press of the **PLAY** Key begins playing the next previously recorded block. Press the **MKR/MUTE** Key to stop play.
- ⑳ **PILOT** – Pressing selects the pilot intercom isolation. Press again to deselect pilot isolation.
- ㉑ **COPLT** – Pressing selects the copilot intercom isolation. Press again to deselect copilot isolation.
- ㉒ **PILOT Knob** – Press to switch between volume and squelch control as indicated by the ‘VOL’ or ‘SQ’ being illuminated. Turn to adjust intercom volume or squelch. The **MAN SQ** Key must be selected to allow squelch adjustment.
- ㉓ **PASS Knob** – Turn to adjust Copilot/Passenger intercom volume or squelch. The **MAN SQ** Key must be selected to allow squelch adjustment.
- ㉔ **Reversionary Mode Button** – Pressing manually selects Reversionary Mode.

1.4 SECURE DIGITAL (SD) CARDS



NOTE: Ensure the G1000 System is powered off before inserting an SD card.



NOTE: Refer to Appendix B for instructions on loading database updates.

The PFD and MFD data card slots use Secure Digital (SD) cards and are located on the upper right side of the display bezels. SD cards are used for storing the various databases and system software updates. Each display bezel is equipped with two SD card slots. The top slot is used for importing and exporting flight plans, Flight Data Logging, and loading navigation database updates. The bottom slot of each display contains a Garmin Supplemental Data Card which is used for storing the various databases.

Not all SD cards are compatible with the G1000. Use only SD cards supplied by Garmin or the aircraft manufacturer.

Installing an SD card:

- 1) Insert the SD card in the SD card slot, pushing the card in until the spring latch engages. The front of the card should remain flush with the face of the display bezel.
- 2) To eject the card, gently press on the SD card to release the spring latch.



Figure 1-6 Display Bezel SD Card Slots

1.5 SYSTEM POWER-UP



NOTE: See the Aircraft Flight Manual (AFM) for specific procedures concerning avionics power application and emergency power supply operation.



NOTE: Refer to Appendix A for system-specific annunciations and alerts.

The G1000 System is integrated with the aircraft electrical system and receives power directly from electrical busses. The G1000 PFD, MFD, and supporting sub-systems include both power-on and continuous built-in test features that exercise the processor, RAM, ROM, external inputs, and outputs to provide safe operation.

During system initialization, test annunciations are displayed, as shown in Figure 1-7. All system annunciations should disappear typically within the first minute of power-up. Upon power-up, key annunciator lights also become momentarily illuminated on the Audio Panel.

On the PFD, the AHRS begins to initialize and displays “AHRS ALIGN: Keep Wings Level”. The AHRS should display valid attitude and heading fields typically within the first minute of power-up. The AHRS can align itself both while taxiing and during level flight.

When the MFD powers up, the power-up screen (Figure 1-8) displays the following information:

- System version
- Copyright
- Land database name and version
- Safe Taxi database information
- Terrain database name and version
- Obstacle database name and version
- Navigation database name, version, and effective dates
- Airport Directory name, version and effective dates
- FliteCharts/ChartView database information

Current database information includes database type, cycle number, or valid operating dates. Review the listed information for currency (to ensure that no databases have expired).

Pressing the **ENT** Key (or right-most softkey) acknowledges this information, and the Navigation Map Page is displayed upon pressing the key a second time. When the system has acquired a sufficient number of satellites to determine a position, the aircraft's current position is shown on the Navigation Map Page.



Figure 1-7 PFD Initialization

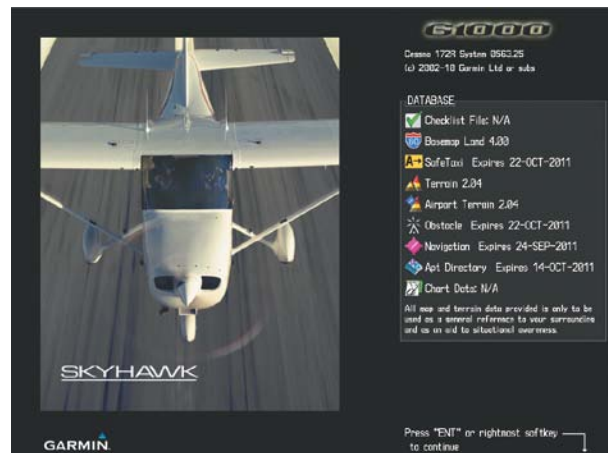

Figure 1-8 MFD Power-Up Screen (172R shown)

1.6 SYSTEM OPERATION



NOTE: In normal operating mode, backlighting can only be adjusted from the PFD. In reversionary mode, it can be adjusted from the remaining display.

The displays are connected together via a single Ethernet bus for high-speed communication. Each IAU is connected to a single display, as shown in Figure 1-1. This allows the units to share information, enabling true system integration.. This section discusses normal and reversionary G1000 display operation, as well as the various AHRS modes and G1000 System Annunciations.

NORMAL DISPLAY OPERATION

In normal operating mode, the PFD presents graphical flight instrumentation (attitude, heading, airspeed, altitude, vertical speed), replacing the traditional flight instrument cluster (see the Flight Instruments Section for more information).

The MFD normally displays a full-color moving map with navigation information (see the Flight Management Section), while the left portion of the MFD is dedicated to the Engine Indication System (EIS; see the EIS Section).

Both displays offer control for COM and NAV frequency selection.



Figure 1-9 Normal Mode

REVERSIONARY DISPLAY OPERATION



NOTE: The G1000 System alerts the pilot when backup paths are utilized by the LRUs. Refer to Appendix A for further information regarding system-specific alerts.

In the event of a display failure, the G1000 System automatically switches to reversionary (backup) mode. In reversionary mode, all important flight information is presented on the remaining display in the same format as in normal operating mode.

If a display fails, the appropriate IAU Ethernet interface to the display is cut off. Thus, the IAU can no longer communicate with the remaining display (refer to Figure 1-1), and the NAV and COM functions provided to the failed display by the IAU are flagged as invalid on the remaining display. The system reverts to backup paths for the AHRS, ADC, Engine/Airframe Unit, and Transponder, as required. The change to backup paths is completely automated for all LRUs and no pilot action is required.



Figure 1-10 Reversionary Mode (Failed PFD)

If the system fails to detect a display problem, reversionary mode may be manually activated by pressing the Audio Panel's red **DISPLAY BACKUP** button (refer to the Audio Panel and CNS Section for further details). Pressing this button again deactivates reversionary mode.



Figure 1-11 DISPLAY BACKUP Button

AHRS OPERATION



NOTE: Refer to Appendix A for specific AHRS alert information.



NOTE: Aggressive maneuvering while AHRS is not operating normally may degrade AHRS accuracy.

The Attitude and Heading Reference System (AHRS) performs attitude, heading, and vertical acceleration calculations for the G1000 System, utilizing GPS, magnetometer, and air data in addition to information from its internal sensors. Attitude and heading information are updated on the PFD while the AHRS receives appropriate combinations of information from the external sensor inputs.

Loss of GPS, magnetometer, or air data inputs is communicated to the pilot by message advisory alerts. Any failure of the internal AHRS inertial sensors results in loss of attitude and heading information (indicated by red 'X' flags over the corresponding flight instruments).

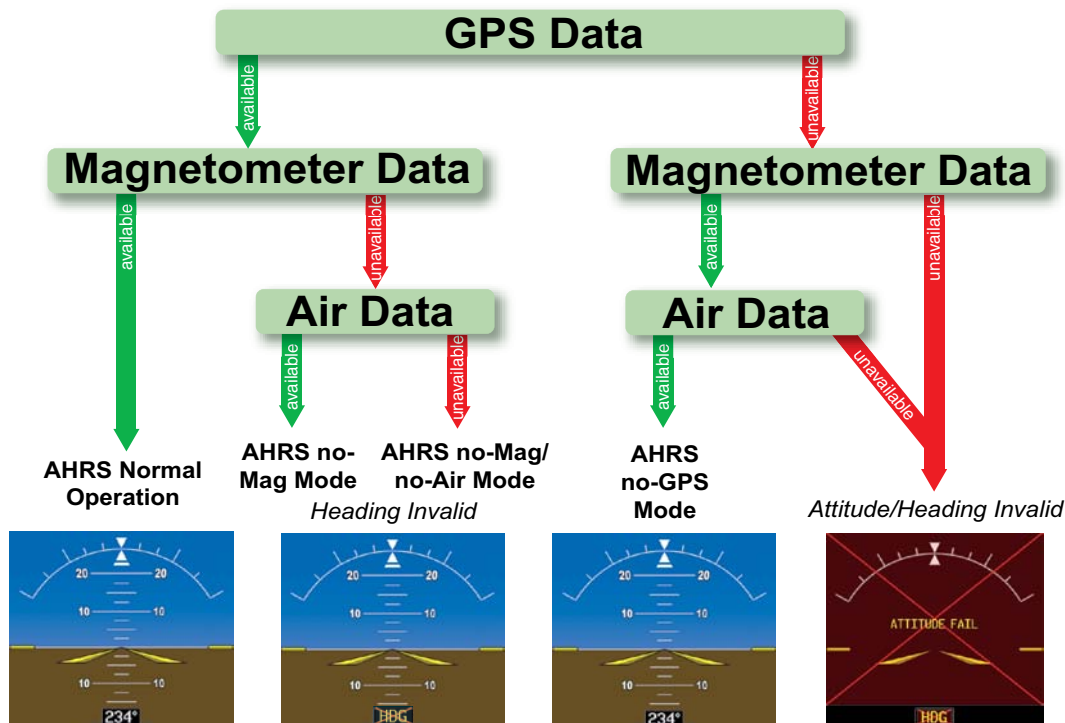

Figure 1-12 AHRS Operation

GPS INPUT FAILURE



NOTE: In-flight initialization of AHRS, when operating without any valid source of GPS data and at true air speed values greater than approximately 200 knots, is not guaranteed. Under these rare conditions, it is possible for in-flight AHRS initialization to take an indefinite amount of time which would result in an extended period of time where valid AHRS outputs are unavailable.

Two GPS inputs are provided to the AHRS. If GPS information from one of the inputs fails, the AHRS uses the remaining GPS input and an alert message is issued to inform the pilot. If both GPS inputs fail, the AHRS can continue to provide attitude and heading information to the PFD as long as magnetometer and airspeed data are available and valid.

MAGNETOMETER FAILURE

If the magnetometer input fails, the AHRS continues to output valid attitude information; however, the heading output on the PFD is flagged as invalid with a red 'X'.

AIR DATA INPUT FAILURE

Failure of the air data input has no affect on the AHRS output while AHRS is receiving valid GPS information. Invalid/unavailable airspeed data in addition to GPS failure results in loss of all attitude and heading information.

G1000 SYSTEM ANNUNCIATIONS

NOTE: For a detailed description of all annunciations and alerts, refer to Appendix A. Refer to the Pilot's Operating Handbook (POH) for additional information regarding pilot responses to these annunciations.

When an LRU or an LRU function fails, a large red "X" is typically displayed on windows associated with the failed data (Figure 1-13 displays all possible flags and responsible LRUs). Upon G1000 power-up, certain windows remain invalid as equipment begins to initialize. All windows should be operational within one minute of power-up. If any window remains flagged, the G1000 system should be serviced by a Garmin-authorized repair facility.

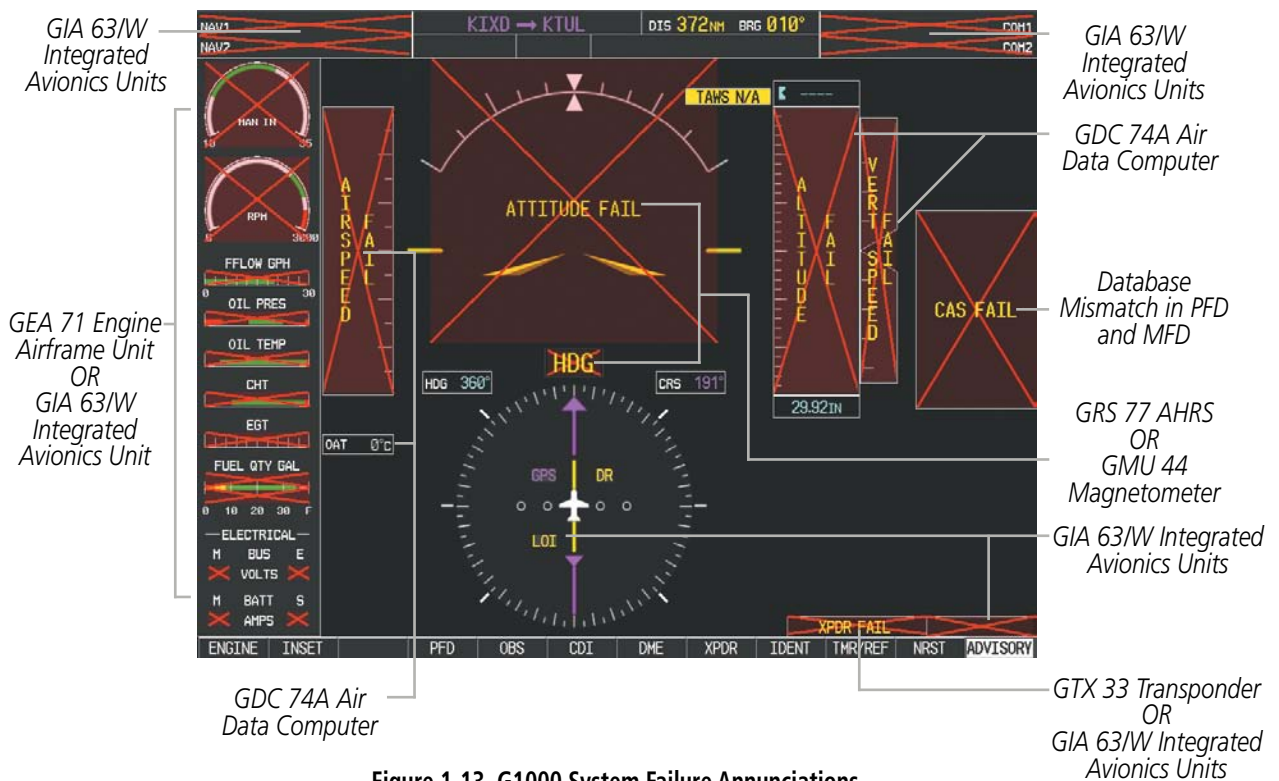

Figure 1-13 G1000 System Failure Annunciations

SOFTKEY FUNCTION

The softkeys are located along the bottoms of the displays. The softkeys shown depend on the softkey level or page being displayed. The bezel keys below the softkeys can be used to select the appropriate softkey. When a softkey is selected, its color changes to black text on gray background and remains this way until it is turned off, at which time it reverts to white text on black background.



Figure 1-14 Softkeys (Second-Level PFD Configuration)

PFD SOFTKEYS

The **CDI**, **IDENT**, **TMR/REF**, **NRST**, and **ALERTS** softkeys undergo a momentary change to black text on gray background and automatically switch back to white text on black background when selected.

The PFD softkeys provide control over flight management functions, including GPS, NAV, terrain, traffic, and lightning (optional). Each softkey sublevel has a **BACK** Softkey which can be selected to return to the previous level. The **ALERTS** Softkey is visible at all softkey levels (label changes if messages are issued).

INSET		Displays Inset Map in PFD lower left corner
	OFF	Removes Inset Map
	DCLTR (3)	Selects desired amount of map detail; cycles through declutter levels: DCLTR (No Declutter): All map features visible DCLTR-1 : Declutters land data DCLTR-2 : Declutters land and SUA data DCLTR-3 : Removes everything except for the active flight plan
	WX LGND	Displays icon and age on the Inset Map for the selected weather products (optional)
	TRAFFIC	Cycles through traffic display options: TRFC-1 : Traffic displayed on inset map TRFC-2 : Traffic Map Page is displayed in the inset map window
	TOPO	Displays topographical data (e.g., coastlines, terrain, rivers, lakes) and elevation scale on Inset Map
	TERRAIN	Displays terrain information on Inset Map
	STRMSCP	Displays Stormscope® information on Inset Map
	NEXRAD or PRECIP	Displays NEXRAD weather and coverage information on Inset Map (optional) Displays GFDS or FIS-B precipitation on Inset Map (optional)
	XM LTNG or DL LTNG	Displays XM WX lightning information on Inset Map (optional) Displays GFDS Worldwide Weather lightning information on Inset Map (optional)
	METAR	Displays METAR flags on airport symbols shown on the Inset Map (optional)
PFD		Displays second-level softkeys for additional PFD configurations
	SYN VIS	Displays the softkeys for enabling or disabling Synthetic Vision features
	PATHWAY	Displays rectangular boxes representing the horizontal and vertical flight path of the active flight plan
	SYN TERR	Enables synthetic terrain depiction
	HRZN HDG	Displays compass heading along the Zero-Pitch line
	APTSIGNS	Displays position markers for airports within approximately 15 nm of the current aircraft position. Airport identifiers are displayed when the airport is within approximately 9 nm.
	DFLT5	Resets PFD to default settings, including changing units to standard

	WIND		Displays softkeys to select wind data parameters
		OPTN 1	Wind direction arrows with headwind and crosswind components
		OPTN 2	Wind direction arrow and speed
		OPTN 3	Wind direction arrow with direction and speed
		OFF	Information not displayed
	DME		Displays the DME Information Window
	BRG1		Cycles the Bearing 1 Information Window through NAV1, GPS/ waypoint identifier and GPS-derived distance information, and ADF/frequency
	HSI FRMT		Provides access to the HSI formatting softkeys
		360 HSI	Displays the HSI in a 360 degree view
		ARC HSI	Displays the HSI as an arc
	BRG2		Cycles the Bearing 2 Information Window through NAV2 or GPS waypoint identifier and GPS-derived distance information, and ADF/frequency.
	ALT UNIT		Displays softkeys for setting the altimeter and BARO settings to metric units
		METERS	When enabled, displays altimeter in meters
		IN	Press to display the BARO setting as inches of mercury
		HPA	Press to display the BARO setting as hectopacals
	STD BARO		Sets barometric pressure to 29.92 in Hg (1013 hPa if METRIC Softkey is selected)
OBS			Selects OBS mode on the CDI when navigating by GPS (only available with active leg)
CDI			Cycles through GPS, VOR1, and VOR2 navigation modes on the CDI
DME			Displays the DME Tuning Window, allowing selection of the DME
XPDR			Displays transponder mode selection softkeys
	STBY		Selects standby mode (transponder does not reply to any interrogations)
	ON		Selects Mode A (transponder replies to interrogations)
	ALT		Selects Mode C – altitude reporting mode (transponder replies to identification and altitude interrogations)
	GND		Allows manual selection of ground mode in certain conditions
	VFR		Automatically enters the VFR code (1200 in the U.S.A. only)
	CODE		Displays transponder code selection softkeys 0-7
		0 — 7	Use numbers to enter code
	IDENT		Activates the Special Position Identification (SPI) pulse for 18 seconds, identifying the transponder return on the ATC screen
	BKSP		Removes numbers entered, one at a time
IDENT			Activates the Special Position Identification (SPI) pulse for 18 seconds, identifying the transponder return on the ATC screen
TMR/REF			Displays Timer/References Window
NRST			Displays Nearest Airports Window
ALERTS			Displays Alerts Window

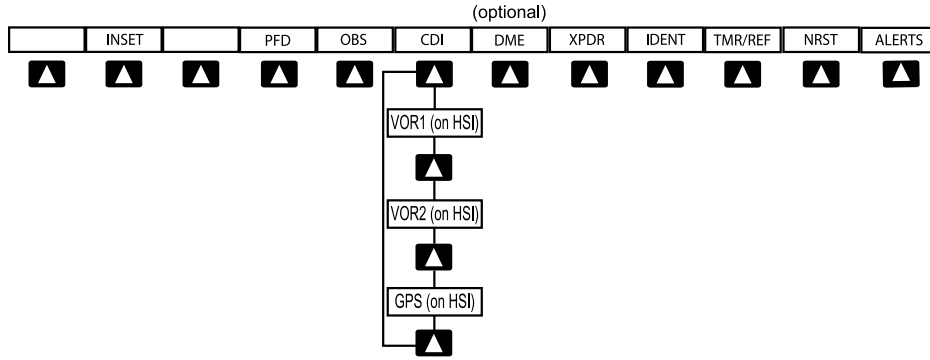

Figure 1-15 Top Level PFD Softkeys

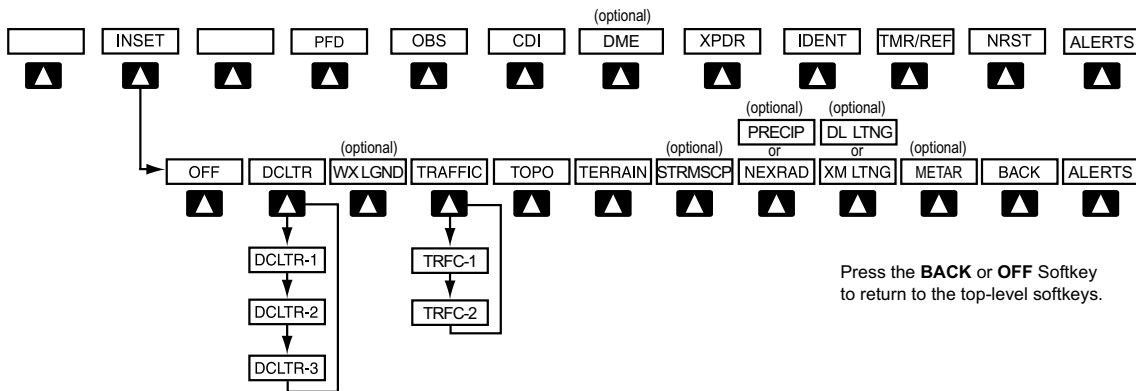

Figure 1-16 INSET Softkeys

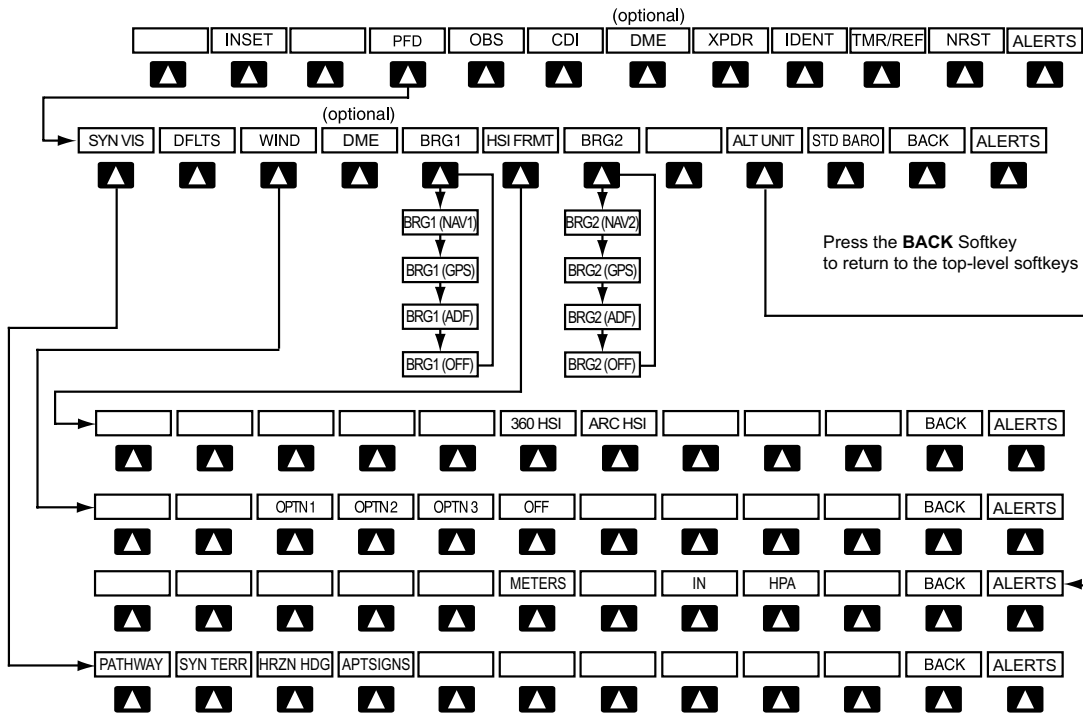

Figure 1-17 PFD Configuration Softkeys

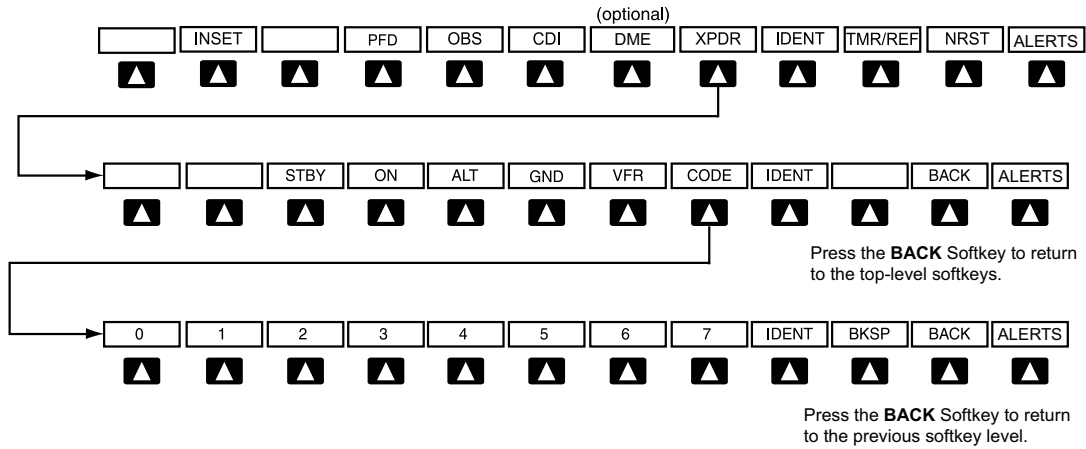

Figure 1-18 XPDR (Transponder) Softkeys

MFD SOFTKEYS

ENGINE				Pressing this softkey makes available the LEAN and SYSTEM Softkeys
	LEAN			Pressing makes available the CYL SLCT and ASSIST Softkeys to facilitate engine leaning
		CYL SLCT		The Cylinder Select Softkey cycles through selection of each cylinder indicated by changing the cylinder display to light blue
		ASSIST		Pressing the ASSIST Softkey causes the first cylinder that peaks to become highlighted and information for that cylinder to be displayed
		BACK		Returns to the previous level softkeys
	SYSTEM			Press this softkey to make available the RST FUEL and GAL REM Softkeys
		RST FUEL		Pressing the Rest Fuel Softkey resets fuel used and gallons remaining to zero
		GAL REM		Press this softkey (Gallons Remaining) to display the quantity adjustment softkeys
			-10 GAL	Pressing decreases the fuel remaining quantity in 10 gallon increments
			-1 GAL	Pressing decreases the fuel remaining quantity in 1 gallon increments
			+1GAL	Pressing increases the fuel remaining quantity in 1 gallon increments
			+10 GAL	Pressing decreases the fuel remaining quantity in 10 gallon increments
			XX GAL	Pressing this softkey sets the fuel remaining to the quantity at the filler neck tab where XX is an airframe specific quantity
			XX GAL	Pressing this softkey sets the fuel remaining to the full tank quantity where XX as an airframe specific quantity

SYSTEM OVERVIEW

FLIGHT INSTRUMENTS

EIS

AUDIO PANEL & CNS

FLIGHT MANAGEMENT

HAZARD AVOIDANCE

AFCS

ADDITIONAL FEATURES

APPENDICES

INDEX

MAP			Enables second-level Navigation Map softkeys
	TRAFFIC		Displays traffic information on Navigation Map
	PROFILE		Displays/removes Profile View on Navigation Map Page
	TOPO		Displays topographical data (e.g., coastlines, terrain, rivers, lakes) and elevation scale on Navigation Map
	TERRAIN		Displays terrain information on Navigation Map
	AIRWAYS (Default label is dependant on map setup option selected)		Displays airways on the map; cycles through the following: AIRWAYS : No airways are displayed AIRWY ON : All airways are displayed AIRWY LO : Only low altitude airways are displayed AIRWY HI : Only high altitude airways are displayed
	STRMSCP		Pressing this softkey displays/removes Stormscope lightning data on the Navigation Map.
	NEXRAD or PRECIP		Displays NEXRAD weather and coverage information on the Navigation Map (optional) Displays GFDS or FIS-B precipitation on Navigation Map (optional)
	XM LTNG or DL LTNG		Displays XM WX lightning information on the Navigation Map (optional) Displays GFDS Worldwide Weather lightning information on the Navigation Map (optional)
	METAR		Displays METAR flags on airport symbols shown on the Navigation Map
	LEGEND		Displays the legend for the selected weather products. Available only when NEXRAD , XM LTNG , METAR and/or PROFILE softkeys are selected.
	BACK		Returns to top-level softkeys
DCLTR (3)			Selects desired amount of map detail; cycles through declutter levels: DCLTR (No Declutter): All map features visible DCLTR-1 : Declutters land data DCLTR-2 : Declutters land and SUA data DCLTR-3 : Removes everything except for the active flight plan
SHW CHRT			Displays the appropriate chart
CHKLIST			Displays the Checklist Page

	ENGINE			Displays the engine checklist
	CHECK			Pressing this softkey checks off a checklist item. If an item is already checked, an UNCHECK Softkey is displayed.
	EXIT			Press to exit the checklist
	EMERGCY			Displays the emergency checklist

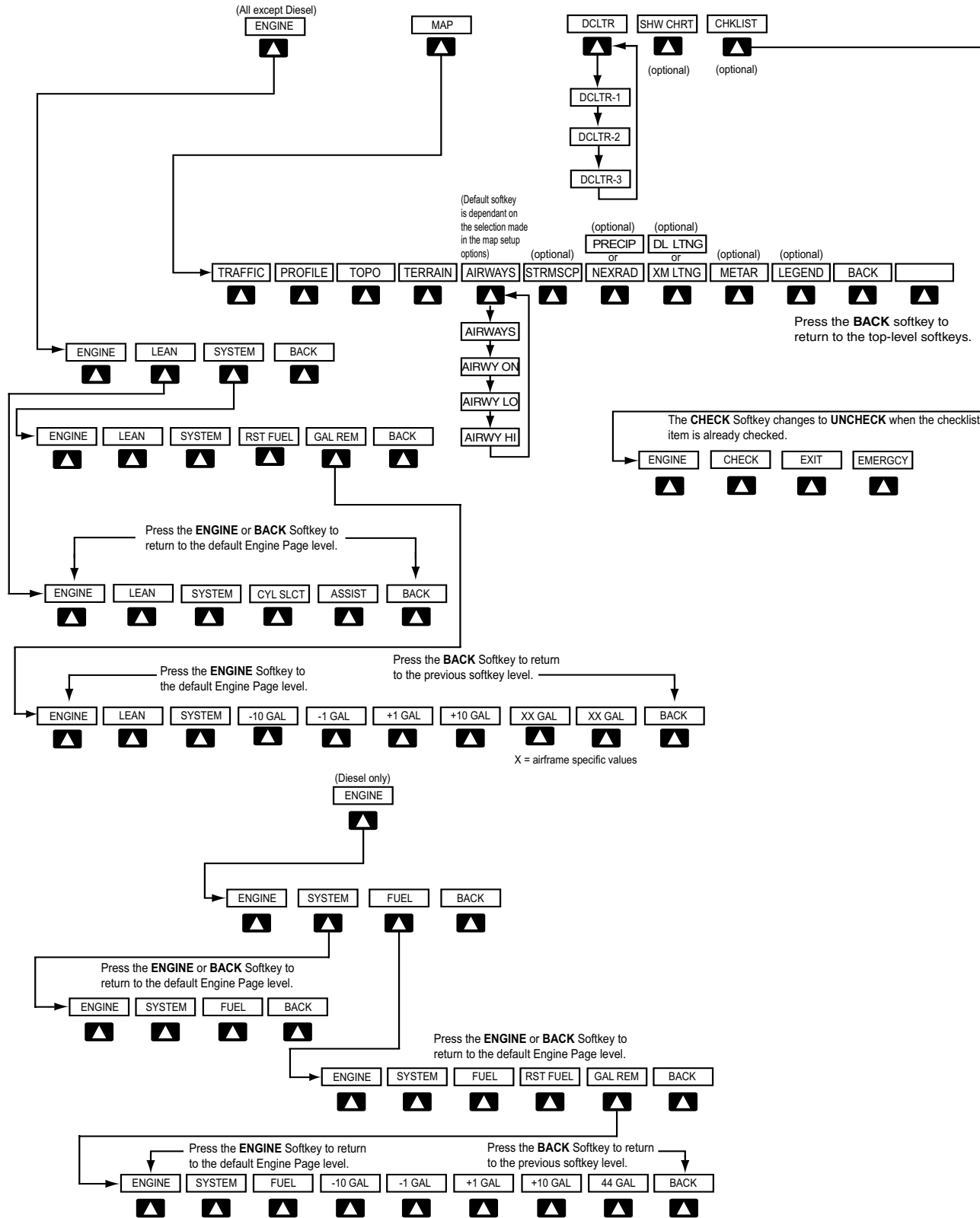

Figure 1-19 MFD Softkeys

GPS RECEIVER OPERATION

Each GIA 63/63W Integrated Avionics Unit (IAU) contains a GPS receiver. Information collected by the specified receiver (GPS1 for the #1 IAU or GPS2 for the #2 IAU) may be viewed on the AUX - GPS Status Page.

These GPS sensor annunciations are most often seen after system power-up when one GPS receiver has acquired satellites before the other, or in SBAS (Satellite Based Augmentation System) capable systems, one of the GPS receivers has not yet acquired an SBAS signal. While the aircraft is on the ground, the SBAS signal may be blocked by obstructions causing one GPS receiver to have difficulty acquiring a good signal. Also, while airborne, turning the aircraft may result in one of the GPS receivers temporarily losing the SBAS signal.

If the sensor annunciation persists, check for a system failure message in the Messages Window on the PFD. If no failure message exists, check the GPS Status Page and compare the information for GPS1 and GPS2. Discrepancies may indicate a problem.

Viewing GPS receiver status information

- 1) Use the large **FMS** Knob on the MFD to select the Auxiliary Page Group (see Section 1.7 for information on navigating MFD page groups).
- 2) Use the small **FMS** Knob to select GPS Status Page.

Selecting the GPS receiver for which data may be reviewed

- 1) Use the **FMS** Knob to select the AUX - GPS Status Page.
- 2) To change the selected GPS receiver:
 - a) Press the desired **GPS** Softkey.

Or:

 - a) Press the **MENU** Key.
 - b) Use the **FMS** Knob to highlight the receiver which is not selected and press the **ENT** Key.

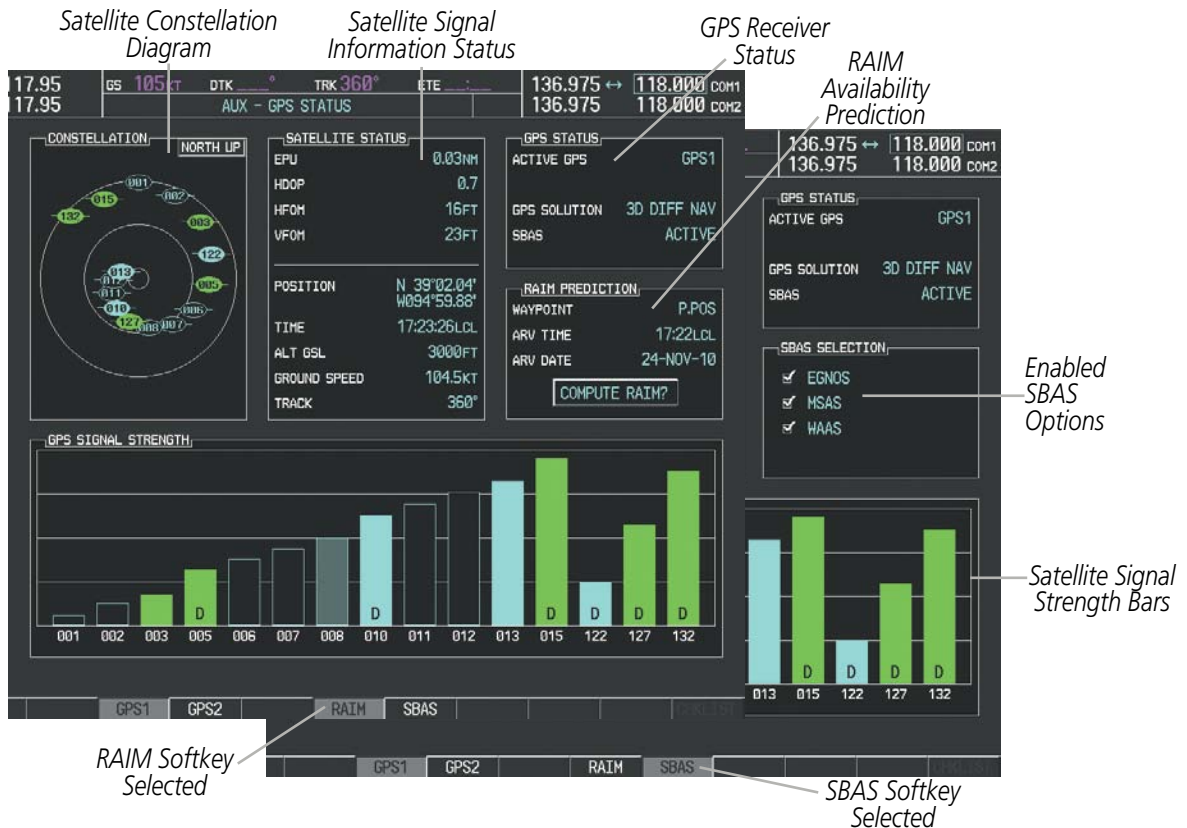

Figure 1-20 GPS Status Page (RAIM or SBAS Selected)

The GPS Status Page provides the following information:

- Satellite constellation diagram

Satellites currently in view are shown at their respective positions on a sky view diagram. The sky view is always in a north-up orientation, with the outer circle representing the horizon, the inner circle representing 45° above the horizon, and the center point showing the position directly overhead.

Each satellite is represented by an oval containing the Pseudo-random noise (PRN) number (i.e., satellite identification number). Satellites whose signals are currently being used are represented by solid ovals.

- Satellite signal information status

The accuracy of the aircraft's GPS fix is calculated using Estimated Position Uncertainty (EPU), Dilution of Precision (DOP), and horizontal and vertical figures of merit (HFOM and VFOM). EPU is the radius of a circle centered on an estimated horizontal position in which actual position has 95% probability of laying. EPU is a statistical error indication and not an actual error measurement.

DOP measures satellite geometry quality (i.e., number of satellites received and where they are relative to each other) on a range from 0.0 to 9.9, with lower numbers denoting better accuracy. HFOM and VFOM, measures of horizontal and vertical position uncertainty, are the current 95% confidence horizontal and vertical accuracy values reported by the GPS receiver.

The current calculated GPS position, time, altitude, ground speed, and track for the aircraft are displayed below the satellite signal accuracy measurements.

- GPS receiver status

The GPS solution type (ACQUIRING, 2D NAV, 2D DIFF NAV, 3D NAV, 3D DIFF NAV) for the active GPS receiver (GPS1 or GPS2) is shown in the upper right of the GPS Status Page. When the receiver is in the process of acquiring enough satellite signals for navigation, the receiver uses satellite orbital data (collected continuously from the satellites) and last known position to determine the satellites that should be in view. ACQUIRING is indicated as the solution until a sufficient number of satellites have been acquired for computing a solution.

When the receiver is in the process of acquiring a 3D navigational GPS solution, 3D NAV is indicated as the solution until the 3D differential fix has finished acquisition. SBAS (Satellite-Based Augmentation System) indicates INACTIVE. When acquisition is complete, the solution status indicates 3D DIFF NAV and SBAS indicates ACTIVE.

- RAIM (Receiver Autonomous Integrity Monitoring) Prediction (**RAIM** Softkey is selected)

In most cases performing a RAIM prediction is not necessary. However, in some cases, the selected approach may be outside the SBAS coverage area and it may be necessary to perform a RAIM prediction for the intended approach.

Receiver Autonomous Integrity Monitoring (RAIM) is a GPS receiver function that performs a consistency check on all tracked satellites. RAIM ensures that the available satellite geometry allows the receiver to calculate a position within a specified RAIM protection limit (2.0 nautical miles for oceanic and enroute, 1.0 nm for terminal, and 0.3 nm for non-precision approaches). During oceanic, enroute, and terminal phases of flight, RAIM is available nearly 100% of the time.

The RAIM prediction function also indicates whether RAIM is available at a specified date and time. RAIM computations predict satellite coverage within ± 15 min of the specified arrival date and time.

Because of the tighter protection limit on approaches, there may be times when RAIM is not available. The G1000 automatically monitors RAIM and warns with an alert message when it is not available. If RAIM is not predicted to be available for the final approach course, the approach does not become active, as indicated by the messages “Approach is not active” and “RAIM not available from FAF to MAP”. If RAIM is not available when crossing the FAF, the missed approach procedure must be flown.

Predicting RAIM availability

- 1) Select the GPS Status Page.
- 2) If necessary, press the **RAIM** Softkey.
- 3) Press the **FMS** Knob. The ‘WAYPOINT’ field is highlighted.
- 4) Turn the small **FMS** Knob to display the Waypoint Information Window.
- 5) Enter the desired waypoint:
 - a) Use the **FMS** Knob to enter the desired waypoint by identifier, facility, or city name and press the **ENT** Key. Refer to Section 1.7 for instructions on entering alphanumeric data into the G1000.

Or:

 - a) Use the large **FMS** Knob to scroll to the Most Recent Waypoints List.
 - b) Use the small **FMS** Knob to highlight the desired waypoint in the list and press the **ENT** Key. The G1000 automatically fills in the identifier, facility, and city fields with the information for the selected waypoint.
 - c) Press the **ENT** Key to accept the waypoint entry.

Or:

- a) To use the present position, press the **MENU** Key.
 - b) With 'Set WPT to Present Position' highlighted, press the **ENT** Key.
 - c) Press the **ENT** Key to accept the waypoint entry.
- 6) Use the **FMS** Knob to enter an arrival time and press the **ENT** Key.
 - 7) Use the **FMS** Knob to enter an arrival date and press the **ENT** Key.
 - 8) With the cursor highlighting 'COMPUTE RAIM?', press the **ENT** Key. Once RAIM availability is computed, one of the following is displayed:
 - 'COMPUTE RAIM?'—RAIM has not been computed for the current waypoint, time, and date combination
 - 'COMPUTING AVAILABILITY'—RAIM calculation in progress
 - 'RAIM AVAILABLE'—RAIM is predicted to be available for the specified waypoint, time, and date
 - 'RAIM NOT AVAILABLE'—RAIM is predicted to be unavailable for the specified waypoint, time, and date
- SBAS Selection (**SBAS** Softkey is pressed)(WAAS, EGNOS, or MSAS capable systems only)

In certain situations, such as when the aircraft is outside or on the fringe of the WAAS, EGNOS, or MSAS coverage area, it may be desirable to disable the reception of the applicable SBAS signal (although it is not recommended). When disabled, the SBAS field in the GPS Status box indicates DISABLED. There may be a small delay for the GPS Status box to be updated upon WAAS, EGNOS, and MSAS enabling/disabling.

Disabling WAAS, EGNOS or MSAS

- 1) Select the GPS Status Page.
 - 2) If necessary, press the **SBAS** Softkey.
 - 3) Press the **FMS** Knob, and turn the large FMS Knob to highlight the desired SBAS system.
 - 4) Press the **ENT** Key to uncheck the box.
 - 5) Press the **FMS** Knob to remove the cursor.
- GPS Satellite Signal Strengths

The GPS Status Page can be helpful in troubleshooting weak (or missing) signal levels due to poor satellite coverage or installation problems. As the GPS receiver locks onto satellites, a signal strength bar is displayed for each satellite in view, with the appropriate satellite PRN number (01-32 or 120-138 for WAAS) below each bar. The progress of satellite acquisition is shown in three stages, as indicated by signal bar appearance:

 - No bar—Receiver is looking for the indicated satellite
 - Hollow bar—Receiver has found the satellite and is collecting data
 - Light blue bar—Receiver has collected the necessary data and the satellite signal can be used
 - Green bar—Satellite is being used for the GPS solution
 - Checkered bar—Receiver has excluded the satellite (Fault Detection and Exclusion)
 - "D" indication—Denotes the satellite is being used as part of the differential computations

Each satellite has a 30-second data transmission that must be collected (signal strength bar is hollow) before the satellite may be used for navigation (signal strength bar becomes solid).

1.7 ACCESSING G1000 FUNCTIONALITY

MENUS

The G1000 has a **MENU** Key that, when pressed, displays a context-sensitive list of options. This options list allows the user to access additional features or make settings changes which specifically relate to the currently displayed window/page. There is no all-encompassing menu. Some menus provide access to additional submenus that are used to view, edit, select, and review options. Menu display 'NO OPTIONS' when there are no options for the window/page selected. The main controls used in association with all window/page group operations are described in section 1.3. Softkey selection does not display menus or submenus.

Navigating the Page Menu Window:

- 1) Press the **MENU** Key to display the Page Menu Window.
- 2) Turn the **FMS** Knob to scroll through a list of available options (a scroll bar appears to the right of the window when the option list is longer than the window).
- 3) Press the **ENT** Key to select the desired option.
- 4) The **CLR** Key may be pressed to remove the menu and cancel the operation. Pressing the **FMS** Knob also removes the displayed menu.

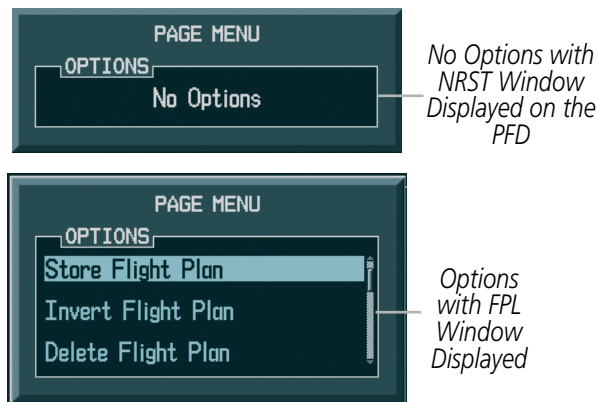

Figure 1-21 Page Menu Examples

MFD PAGE GROUPS



NOTE: Refer to the *Flight Management*, *Hazard Avoidance*, and *Additional Features* sections for details on specific pages.

Information on the MFD is presented on pages which are grouped according to function. The page group and active page title are displayed in the upper center of the screen, below the Navigation Status Box. In the bottom right corner of the screen, the page group tabs are displayed along the bottom. Available pages in the group are displayed in a list above the page groups. The current page group and current page within the group are shown in cyan. For some of these pages (Airport/Procedures/Weather Information, XM WX Satellite Weather, Procedure Loading), the active title of the page changes while the page name in the list remains the same.

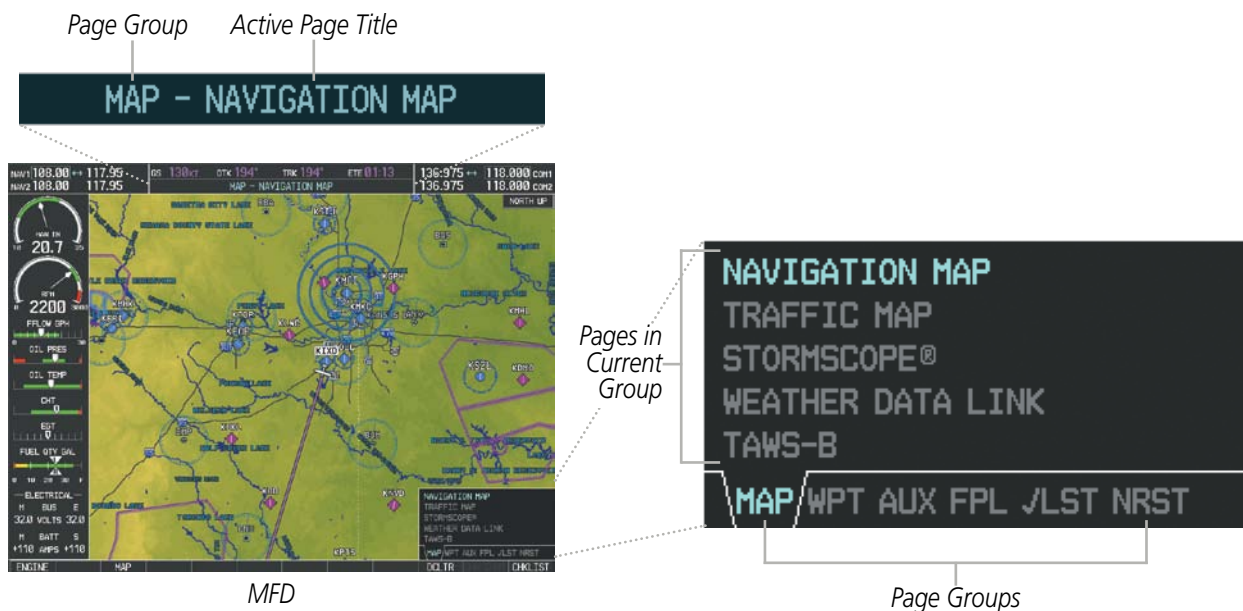

Figure 1-22 Page Title and Page Groups

Selecting a page using the FMS Knob:

- 1) Turn either **FMS** Knob one click to display the pop-up page selection window.
- 2) Turn the large **FMS** Knob until the desired page group is selected. For example, the MAP page group is selected in Figure 1-22.
- 3) Turn the small **FMS** Knob until the desired page is selected.

There are also several pages (Airport Information and XM Information pages) which are selected first from within a main page group with the **FMS** Knobs, then with the appropriate softkey at the bottom of the page. In this case, the page remains set to the selected screen until a different screen softkey is pressed.

Map Pages (MAP)

- Navigation Map
- Traffic Map
- Stormscope®
- Weather Data Link (*service optional*)
 - XM WX Satellite Weather
 - FIS-B Weather
 - GFDS Worldwide Weather
- Terrain Proximity/Terrain-SVS/
TAWS-B

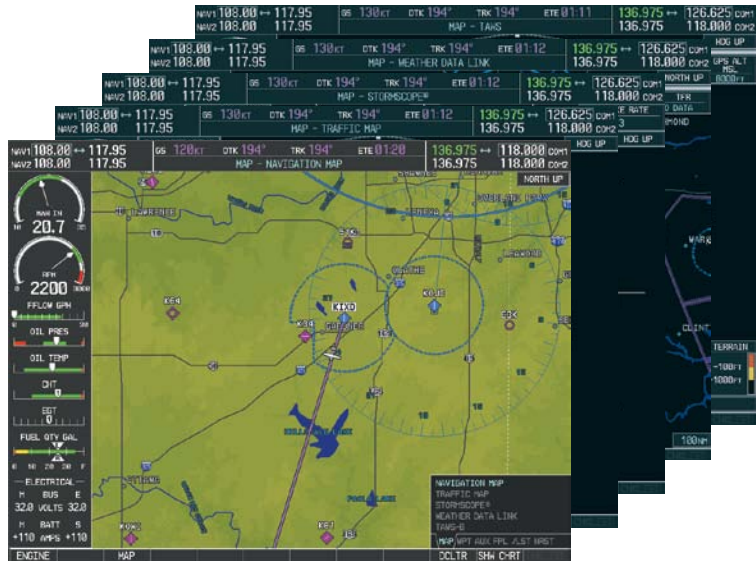
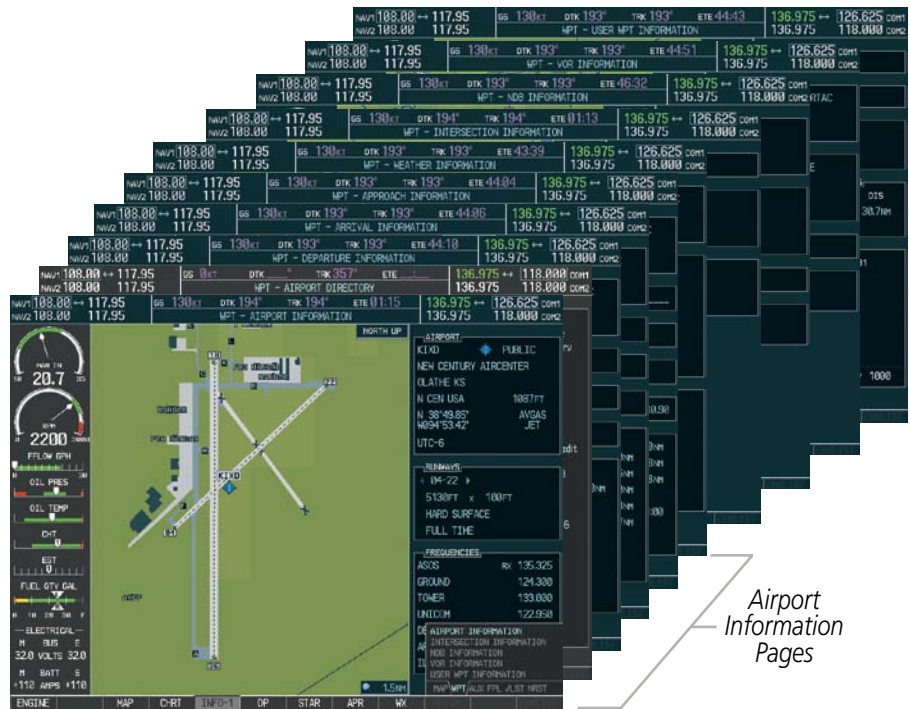

Figure 1-23 Map Pages

Waypoint Pages (WPT)

- Airport Information pages
 - Airport Information (**INFO-1** Softkey)
 - Airport Directory (**INFO-2** Softkey)
 - Departure Information (**DP** Softkey)
 - Arrival Information (**STAR** Softkey)
 - Approach Information (**APR** Softkey)
 - Weather Information (**WX** Softkey)
- Intersection Information
- NDB Information
- VOR Information
- User Waypoint Information



Airport Information Pages

Figure 1-24 Waypoint Pages

Auxiliary Pages (AUX)

- Trip Planning
- Utility
- GPS Status
- System Setup
- SiriusXM Satellite pages
 - XM Information (**INFO** Softkey)
 - XM Radio (**RADIO** Softkey)
- System Status
- Video (Optional)



SiriusXM Satellite Pages

Figure 1-25 Auxiliary Pages

Flight Plan Pages (FPL)

- Active Flight Plan
 - Wide View, Narrow View (**VIEW** Softkey)
- Flight Plan Catalog
- or
- Stored Flight Plan (**NEW** Softkey)



Figure 1-26 Flight Plan Pages

The Flight Plan Pages may also be accessed using the **FPL** Key. Main pages within this group are selected by turning the small **FMS** Knob.

The Checklist Page may be accessed from the page group tab or the **CHKLST** Softkey. See the Additional Features section for a discussion on checklists.

Nearest Pages (NRST)

- Nearest Airports
- Nearest Intersections
- Nearest NDB
- Nearest VOR
- Nearest User Waypoints
- Nearest Frequencies
- Nearest Airspaces

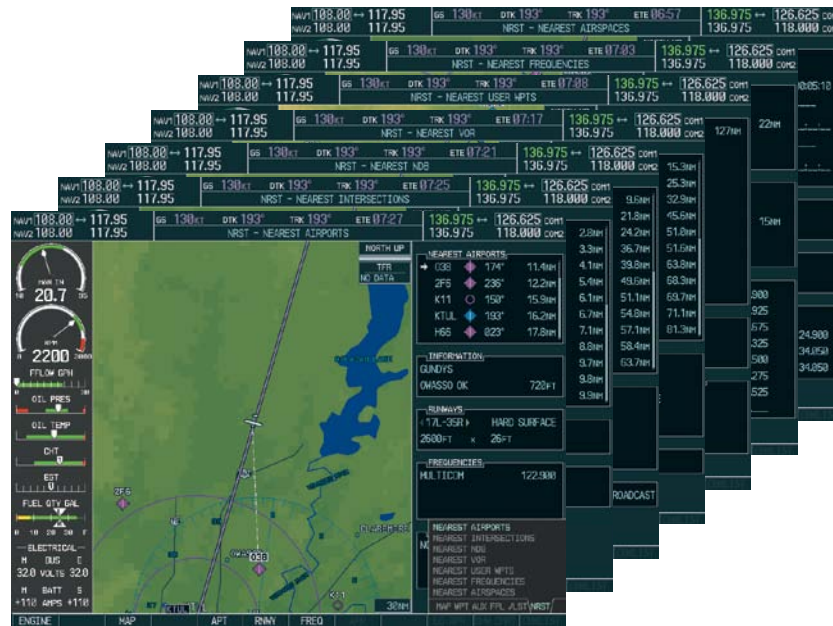

Figure 1-27 Nearest Pages

In addition to the main page groups accessed exclusively using the **FMS** Knobs, there are pages for flight planning (FPL) and loading procedures (PROC) which are accessed by bezel key. In some instances, softkeys may be used to access the Procedure Pages.

The Flight Plan Pages are accessed using the **FPL** Key on the MFD. Main pages within this group are selected by turning the small **FMS** Knob.

The Procedure pages may be accessed at any time on the MFD by pressing the **PROC** Key. A menu is initialized, and when a departure, approach, or arrival is selected, the appropriate Procedure Loading Page is opened. Turning the **FMS** Knob does not scroll through the Procedure pages (note the single page icon in the lower right corner).

Procedure Pages (PROC)

- Departure Loading
- Arrival Loading
- Approach Loading

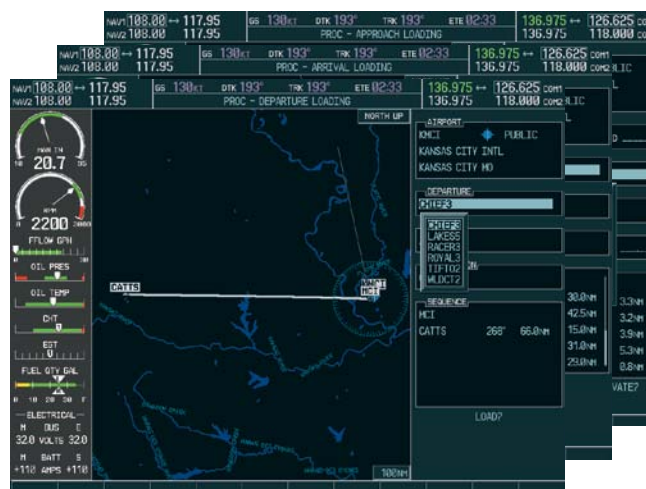

Figure 1-28 Procedure Pages

For some of these pages (Airport Information pages, SiriusXM Satellite pages, Procedure pages), the title of the page may change while the page icon remains the same.

SYSTEM OVERVIEW

FLIGHT INSTRUMENTS

EIS

AUDIO PANEL & CNS

FLIGHT MANAGEMENT

HAZARD AVOIDANCE

AFCS

ADDITIONAL FEATURES

APPENDICES

INDEX

MFD SYSTEM PAGES

In the Auxiliary (AUX) Page Group, there are two system pages: System Setup and System Status. The System Setup Page allows management of various system parameters, while the System Status Page displays the status of all G1000 system LRUs.

SYSTEM SETUP PAGE

The System Setup Page allows management of the following system parameters:

- Time display format (local or UTC)
- Displayed measurement units
- Baro transition alert (see Flight Instruments Section)
- Arrival Alerts
- Airspace alerts
- Audio alert voice
- Flight director format (only the single que option is available in the Cessna Nav III)
- Page Navigation
- MFD Data Bar (Navigation Status Box) fields
- GPS Course Deviation Indicator (CDI) range
- COM transceiver channel spacing
- Displayed nearest airports

Selecting the System Setup Page:

- 1) Turn the large **FMS** Knob to select the AUX Page group.
- 2) Turn the small **FMS** Knob to display the System Setup Page.

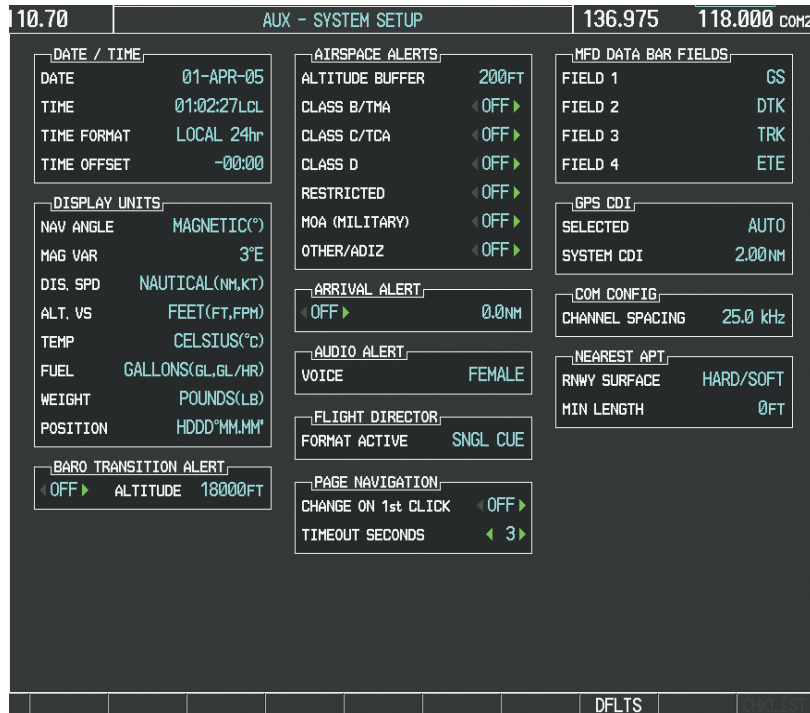

Figure 1-29 System Setup Page

DATE/TIME

The Date/Time Box on the System Setup Page displays the current date and time and allows the pilot to set the time format (local 12-hr, local 24-hr, or UTC) and offset. The time offset is used to define current local time. UTC (also called GMT or Zulu) date and time are calculated directly from the GPS satellites signals and cannot be changed. When using a local time format, designate the offset by adding or subtracting the desired number of hours.

Set the system time format:

- 1) While on the System Setup Page, press the **FMS** Knob momentarily to activate the flashing cursor.
- 2) Turn the large **FMS** Knob to highlight the time format field in the Date/Time Box.
- 3) Turn the small **FMS** Knob to select the desired system time format (local 12hr, local 24hr, UTC) and press the **ENT** Key.

Set the current time offset:

- 1) While on the System Setup Page, press the **FMS** Knob momentarily to activate the flashing cursor.
- 2) Turn the large **FMS** Knob to highlight the time offset field in the Date/Time Box.
- 3) Turn the **FMS** Knobs to enter the time offset and press the **ENT** Key.

DISPLAY UNITS

The Display Units Box on the System Setup Page allows configuration of the measurement units used for the following displayed data:

- Nav angle (magnetic, true)
 - When set to 'MAGNETIC', magnetic variation is figured into the displayed value. When 'TRUE' is selected, no magnetic variation is calculated and a 'T' is displayed next to the value.
 - Affects the BRG field in the PFD Navigation Status Box.
 - Affects Current Heading, Selected Heading, and Selected Course boxes on the PFD.
 - Affects the BRG, DTK, TKE, TRK, and XTK fields in the MFD Navigation Status Box.
- Distance and speed (metric, nautical)
 - Affects the DIS field in the PFD Navigation Status Box and the range setting of the Inset Map.
 - Affects all distance and speed displays on the MFD with the exception of the displayed wind speed displayed on the Navigation Map Page. Wind speed is affected on the Trip Planning Page.
- Altitude and vertical speed (feet, meters)
 - Affects all altitude and elevation displays on the MFD, with the exception of VNAV altitudes on the Active Flight Plan Page.
- Temperature (Celsius, Fahrenheit)
 - Affects all temperature displays on the PFD.
 - Affects the temperature display on the Trip Planning Page. Does not affect the Engine Indicating System display.

- Fuel and fuel flow (gallons, gallons/hour)
Indicates fuel quantities are measured in gallons and fuel flow is measured in gallons per hour.
- Weight (pounds, kilograms)
The weight setting is not applicable to the Nav III.
- Position (HDDD°MM.MM', HDDD°MM'SS.S", MGRS)
Affects all position displays.

Change a Display Units setting:

- 1) While on the System Setup Page, press the **FMS** Knob momentarily to activate the flashing cursor.
- 2) Turn the large **FMS** Knob to highlight the desired field in the Display Units Box.
- 3) Turn the small **FMS** Knob to select from a list of measurement units and press the **ENT** Key when the desired unit is highlighted. Press the **CLR** Key to cancel the action without changing the units.

BARO TRANSITION ALERT

See the Flight Instruments section for a discussion on setting the Baro Transition Alert.

AIRSPACE ALERTS

The Airspace Alerts Box allows the pilot to turn the controlled/special-use airspace message alerts on or off. This does not affect the alerts listed on the Nearest Airspaces Page or the airspace boundaries depicted on the MFD Navigation Map Page. It simply turns on/off the warning provided when the aircraft is approaching or near an airspace.

Alerts for the following airspaces can be turned on/off in the Airspace Alerts Box:

- Class B/TMA
- Class C/TCA
- Class D
- Restricted
- MOA (Military)
- Other airspaces

An altitude buffer is also provided which “expands” the vertical range above or below an airspace. For example, if the buffer is set at 500 feet, and the aircraft is more than 500 feet above/below an airspace, an alert message is not generated, but if the aircraft is less than 500 feet above/below an airspace and projected to enter it, the pilot is notified with an alert message. The default setting for the altitude buffer is 200 feet.

Change the altitude buffer distance setting:

- 1) While on the System Setup Page, press the **FMS** Knob momentarily to activate the flashing cursor.
- 2) Turn the large **FMS** Knob to highlight the altitude buffer field in the Airspace Alerts Box.
- 3) Turn the **FMS** Knobs to enter an altitude buffer value and press the **ENT** Key.

To turn an airspace alert on or off:

- 1) While on the System Setup Page, press the **FMS** Knob momentarily to activate the flashing cursor.
- 2) Turn the large **FMS** Knob to highlight the desired field in the Airspace Alerts Box.
- 3) Turn the small **FMS** Knob clockwise to turn the airspace alert ON or counterclockwise to turn the alert OFF.

ARRIVAL ALERTS

The Arrival Alert Box on the System Setup Page allows the Alerts Window arrival alerts to be turned ON/OFF, and the alert trigger distance (up to 99.9 units) set for alerts in the Alerts Window and the PFD Navigation Status Box. An arrival alert can be set to notify the pilot with a message upon reaching a user-specified distance from the final destination (the direct-to waypoint or the last waypoint in a flight plan). When Arrival Alerts is set to ON, and the set distance is reached, an “Arrival at waypoint” message is displayed in the PFD Navigation Status Box, and a “WPT ARRIVAL - Arriving at waypoint - [xxxx]” is displayed in the Alerts Window. When Arrival Alerts is set to OFF, only the PFD Navigation Status Box message “Arriving at waypoint” is displayed, and it is displayed when the time to the final destination is approximately ten seconds.

Enabling/disabling the Alerts Window arrival alert:

- 1) Use the **FMS** Knob to select the AUX - System Setup Page.
- 2) Press the **FMS** Knob momentarily to activate the flashing cursor.
- 3) Turn the large **FMS** Knob to select the ON/OFF field in the Arrival Alert Box.
- 4) Turn the small **FMS** Knob clockwise to turn the airspace alert ON or counterclockwise to turn the alert OFF.

Changing the arrival alert trigger distance:

- 1) Use the **FMS** Knob to select the AUX - System Setup Page.
- 2) Press the **FMS** Knob momentarily to activate the flashing cursor.
- 3) Turn the large **FMS** Knob to highlight the distance field in the Arrival Alert Box.
- 4) Use the **FMS** Knob to enter a trigger distance and press the **ENT** Key.

AUDIO ALERTS

The Audio Alert Box on the System Setup Page allows the audio alert voice to be set to male or female.

To change the audio alert voice:

- 1) While on the System Setup Page, press the **FMS** Knob momentarily to activate the flashing cursor.
- 2) Turn the large **FMS** Knob to highlight the voice in the Audio Alert Box.
- 3) Turn the small **FMS** Knob to display and highlight the desired voice and press the **ENT** Key.

FLIGHT DIRECTOR

Not pilot selectable.

PAGE NAVIGATION

The large **FMS** Knob displays the Page Group Tabs and navigates through the tabs. The small **FMS** Knob navigates through the pages listed within a specific group. The number of clicks it takes to display the Page Group Tabs and change to the next tab can be controlled from the Page Navigation box on the AUX - System Setup Page.

OFF – Displays the Page Group Tabs with one click of either **FMS** Knob.

ON – Displays the Page Group Tabs and navigates to the next tab with one click of either **FMS** Knob.

The pilot can select, from the AUX - System Setup Page, the amount of time the Page Group Tabs are displayed (in the lower right corner of the MFD). The timeout can range from two to ten seconds.

Selecting page navigation settings:

- 1) Use the **FMS** Knob to select the AUX - System Setup Page.
- 2) Press the **FMS** Knob momentarily to activate the flashing cursor.
- 3) Turn the large **FMS** Knob to highlight the 'Change On 1st Click' field in the Page Navigation Box.
- 4) Turn the small **FMS** Knob to select 'OFF' or 'ON'.
- 5) Turn the large **FMS** Knob to highlight the 'Timeout Seconds' field in the Page navigation Box.
- 6) Turn the small **FMS** Knob to select the desired number of seconds
- 7) Press the **FMS** Knob momentarily to remove the flashing cursor.

MFD DATA BAR FIELDS

The MFD Data Bar Fields Box on the System Setup Page displays the current configuration of the MFD Navigation Status Box. By default, the Navigation Status Bar is set to display ground speed (GS), distance to next waypoint (DIS), estimated time enroute (ETE), and enroute safe altitude (ESA).

Change the information shown in an MFD Navigation Status Bar field:

- 1) While on the System Setup Page, press the **FMS** Knob momentarily to activate the flashing cursor.
- 2) Turn the large **FMS** Knob to highlight the desired field number in the MFD Data Bar Fields Box.
- 3) Turn the small **FMS** Knob to display and scroll through the data options list and press the **ENT** Key when the desired data selection is highlighted.

The following data may be selected for display in each of the four fields of the Navigation Status Box.

- Bearing (BRG)
- Crosstrack Error (XTK)
- Distance (DIS)
- Desired Track (DTK)
- Endurance (END)
- En Route Safe Altitude (ESA)
- Estimated Time of Arrival (ETA)
- Estimated Time En Route (ETE)
- Fuel Over Destination (FOD)
- Fuel On Board (FOB)
- Ground Speed (GS)
- Minimum Safe Altitude (MSA)
- True Air Speed (TAS)
- Track Angle Error (TKE)
- Track (TRK)
- Vertical Speed Required (VSR)

GPS CDI

The GPS CDI Box on the System Setup Page allows the pilot to define the range for the on-screen course deviation indicator (CDI). The range values represent full range deflection for the CDI to either side. The default setting is 'AUTO'. At this setting, leaving the departure airport the CDI range is set to 1.0 nm and gradually ramps up to 2 nm beyond 30 nm from the departure airport. The CDI range is set to 2.0 nautical miles during the en route phase of flight. Within 30 nm of the destination airport, the CDI range gradually ramps down to 1.0 nm (terminal area). During approach operations, the CDI range ramps down even further to 0.3 nm. This transition normally occurs within 2.0 nm of the final approach fix (FAF).

If a lower CDI range setting is selected (i.e., 1.0 or 0.3 nm), the higher range settings are not selected during any phase of flight. For example, if 1.0 nm is selected, the system uses this for en route and terminal phases and ramps down to 0.3 nm during an approach. Note that the Receiver Autonomous Integrity Monitoring (RAIM) protection limits follow the selected CDI range and corresponding flight phases.

The GPS CDI Box on the System Setup Page displays the following:

- Selected CDI range (auto, 2 nm, 1 nm, 0.3 nm)
- Current system CDI range (2 nm, 1 nm, 0.3 nm)

Changing the CDI range:

- 1) While on the System Setup Page, press the **FMS** Knob momentarily to activate the flashing cursor.
- 2) Turn the large **FMS** Knob to highlight the selected field in the GPS CDI Box.
- 3) Turn the small **FMS** Knob to display and scroll through the range list and press the **ENT** Key when the desired selection is highlighted.
- 4) Press the **FMS** Knob to deactivate the cursor.

COM CONFIGURATION



NOTE: 8.33 kHz VHF communication frequency channel spacing is not approved for use in the United States. Select the 25.0 kHz channel spacing option for use in the United States.

The COM Configuration Box on the System Setup Page allows the pilot to select 8.33 kHz or 25.0 kHz COM frequency channel spacing.

Change COM channel spacing:

- 1) While on the System Setup Page, press the **FMS** Knob momentarily to activate the flashing cursor.
- 2) Turn the large **FMS** Knob to highlight the channel spacing field in the COM Configuration Box.
- 3) Turn the small **FMS** Knob to select the desired spacing and press the **ENT** Key.

NEAREST AIRPORTS

The Nearest Airports Box on the System Setup Page defines the minimum runway length and surface type used when determining the nine nearest airports to display on the MFD Nearest Airports Page. A minimum runway length and/or surface type can be entered to prevent airports with small runways or runways that

are not of appropriate surface from being displayed. Default settings are zero feet (or meters) for runway length and “HARD/SOFT” for runway surface type.

Select nearest airport surface matching criteria (any, hard only, hard/soft, water):

- 1) While on the System Setup Page, press the **FMS** Knob momentarily to activate the flashing cursor.
- 2) Turn the large **FMS** Knob to highlight the runway surface field in the Nearest Airports Box.
- 3) Turn the small **FMS** Knob to display and scroll through the runway options (any, hard only, hard/soft, water) and press the **ENT** Key when the desired selection is highlighted.

Select nearest airport minimum runway length matching criteria:

- 1) While on the System Setup Page, press the **FMS** Knob momentarily to activate the flashing cursor.
- 2) Turn the large **FMS** Knob to highlight the minimum length field in the Nearest Airport Box.
- 3) Turn the **FMS** Knobs to enter the minimum runway length (zero to 99,999 feet) and press the **ENT** Key.

SYSTEM STATUS PAGE

The System Status Page displays the status and software version numbers for all detected system LRUs. Pertinent information on all system databases is also displayed. Active LRUs are indicated by green check marks and failed LRUs are indicated by red “X”s. Failed LRUs should be noted and a Cessna service center or Garmin dealer informed.

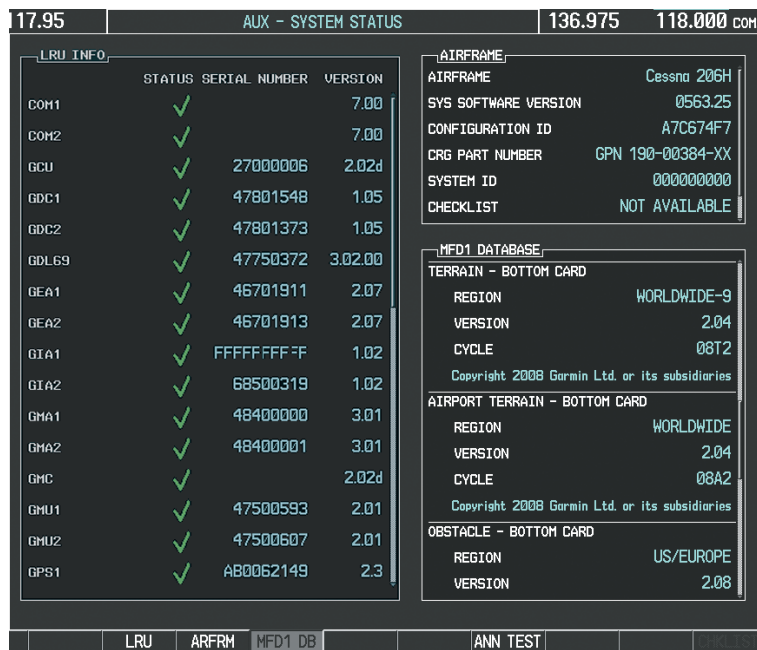

Figure 1-30 Example System Status Page

The **LRU** and **ARFRM** softkeys on the System Status Page select the applicable list (LRU INFO or AIRFRAME window) through which the **FMS** Knob can be used to scroll information within the selected window.

Pressing the Display Database Selection Softkey (background changes to grey indicating the softkey is selected) places the cursor in the DATABASE window. Use the **FMS** Knob to scroll through database information for the database information. Each press of the Display Database Selection Softkey will change the softkey label (**PFD1 DB**, etc) to indicate the display for which database information is displayed.

The **ANN TEST** Softkey, when pressed, causes an annunciation test tone to be played.

SYSTEM UTILITIES

For flight planning purposes, timers, trip statistics, and a scheduler feature are provided on the AUX - Utility Page. The timers available include a stopwatch-like generic timer, a total time in flight timer, and a record of the time of departure. Trip statistics—odometer, trip odometer, and average trip and maximum groundspeeds—are displayed from the time of the last reset. A scheduler feature is also provided so the pilot can enter reminder messages to be displayed at specified intervals in the Alerts Window on the PFD (see the Additional Features Section).

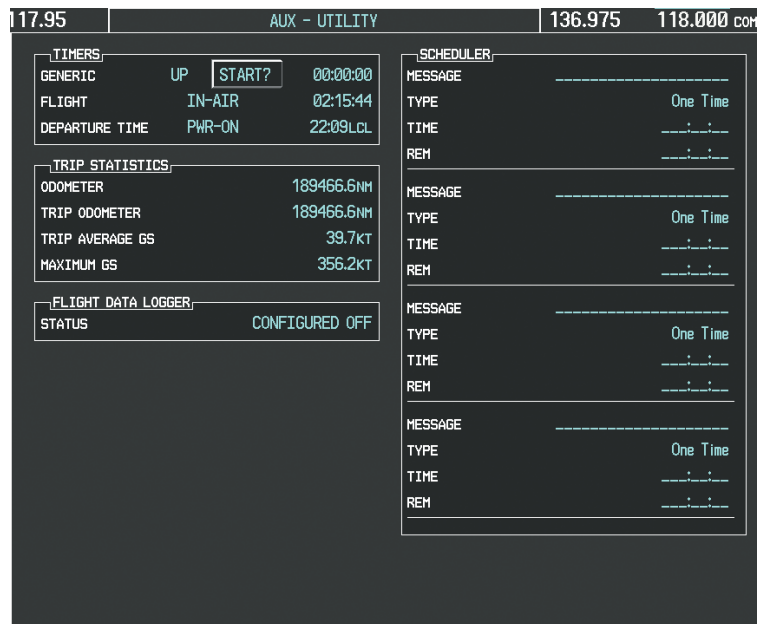

Figure 1-31 Utility Page

TIMERS

The generic timer can be set to count up or down from a specified time (HH:MM:SS). When the countdown on the timer reaches zero the digits begin to count up from zero. If the timer is reset before reaching zero on a countdown, the digits are reset to the initial value. If the timer is counting up when reset, the digits are zeroed.

Setting the generic timer:

- 1) Use the **FMS** Knob to select the AUX - Utility Page.
- 2) Press the **FMS** Knob momentarily to activate the flashing cursor.

- 3) Turn the small **FMS** Knob to select the timer counting direction (UP/DN) and press the **ENT** Key.
- 4) If a desired starting time is desired:
 - a) Use the large **FMS** Knob to highlight the HH:MM:SS field.
 - b) Use the **FMS** Knob to enter the desired time and press the **ENT** Key.
- 5) Turn the large **FMS** Knob to highlight 'START?' and press the **ENT** Key to start the timer. The field changes to 'STOP?'
- 6) To stop the timer, press the **ENT** Key with 'STOP?' highlighted. The field changes to 'RESET?'
- 7) To reset the timer, press the **ENT** Key with 'RESET?' highlighted. The field changes back to 'START?' and the digits are reset.

The flight timer can be set to count up from zero starting at system power-up or from the time that the aircraft lifts off; the timer can also be reset to zero at any time.

Setting the flight timer starting criterion:

- 1) Use the **FMS** Knob to select the AUX - Utility Page.
- 2) Press the **FMS** Knob momentarily to activate the flashing cursor.
- 3) Turn the large **FMS** Knob to highlight the field next to the flight timer.
- 4) Turn the small **FMS** Knob to select the starting criterion (PWR-ON or IN-AIR) and press the **ENT** Key.

Resetting the flight timer:

- 1) Use the **FMS** Knob to select the AUX - Utility Page.
- 2) Press the **MENU** Key.
- 3) With 'Reset Flight Timer' highlighted, press the **ENT** Key.

The G1000 records the time at which departure occurs, depending on whether the pilot prefers the time to be recorded from system power-up or from aircraft lift off. The displayed departure time can also be reset to display the current time at the point of reset. The format in which the time is displayed is controlled from the System Setup Page.

Setting the departure timer starting criterion:

- 1) Use the **FMS** Knob to select the AUX - Utility Page.
- 2) Press the **FMS** Knob momentarily to activate the flashing cursor.
- 3) Turn the large **FMS** Knob to highlight the field next to the departure time.
- 4) Turn the small **FMS** Knob to select the starting criterion (PWR-ON or IN-AIR) and press the **ENT** Key.

Resetting the departure time:

- 1) Use the **FMS** Knob to select the AUX - Utility Page.
- 2) Press the **MENU** Key.
- 3) Use the **FMS** Knob to highlight 'Reset Departure Time' and press the **ENT** Key.

TRIP STATISTICS

The odometer and trip odometer record the total mileage traveled from the last reset; these odometers can be reset independently. Resetting the trip odometer also resets the average trip groundspeed. Maximum groundspeed for the period of time since the last reset is also displayed.

Resetting trip statistics readouts:

- 1) Use the **FMS** Knob to select the AUX - Utility Page.
- 2) Press the **MENU** Key. The following reset options for trip statistics are displayed:
 - Reset Trip ODOM/AVG GS—Resets trip average ground speed readout and odometer
 - Reset Odometer—Resets odometer readout only
 - Reset Maximum Speed—Resets maximum speed readout only
 - Reset All—Resets flight timer, departure timer, odometers, and groundspeed readouts
- 2) Use the **FMS** Knob to highlight the desired reset option and press the **ENT** Key. The selected parameters are reset to zero and begin to display data from the point of reset.

FLIGHT DATA LOGGER

Shows Flight Data Logging status.

SCHEDULER

The Scheduler feature is discussed in the Additional Features section.

1.8 DISPLAY BACKLIGHTING

The G1000 display and control backlighting can be adjusted either automatically or manually.

AUTOMATIC ADJUSTMENT

The existing instrument panel dimmer bus normally controls the PFD and MFD backlighting as well as the PFD and MFD bezels, MFD Control Unit, AFCS Control Unit and audio panel key annunciator lighting. When the dimmer bus is not used by the G1000 system, photocell technology automatically controls backlighting adjustments. Photocell calibration curves are pre-configured to optimize display appearance through a broad range of cockpit lighting conditions.

MANUAL ADJUSTMENT



NOTE: The avionics dimming knob may also be used to adjust backlighting. Refer to the POH for details.



NOTE: In normal mode, backlighting can only be adjusted from the PFD. In reversionary mode, it can also be adjusted from the MFD.



NOTE: No other window can be displayed on the PFD while the PFD Setup Menu Window is displayed.

Backlighting may also be adjusted manually for all of the displays and the associated bezels. The audio panel key backlighting is directly tied to the PFD key backlighting setting.

Adjust display backlighting manually:

- 1) Press the **MENU** Key on the PFD to display the PFD Setup Menu Window. 'AUTO' becomes highlighted to the right of 'PFD DSPL'.

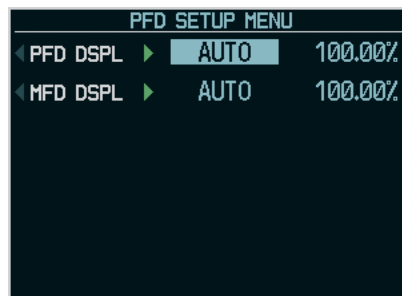

Figure 1-32 Manual Display Backlighting Adjustment

- 2) Turn the small **FMS** Knob to display the selection box. Turn the **FMS** Knob to select 'MANUAL', then press the **ENT** Key. The intensity value becomes highlighted.
- 3) Turn the small **FMS** Knob to select the desired backlighting, then press the **ENT** Key.
- 4) Turn the large **FMS** Knob to highlight 'AUTO' to the right of 'MFD DSPL' and repeat steps 2 and 3.
- 5) Press the **CLR** or **MENU** Key to remove the PFD Setup Menu Window from the display.

Adjust key backlighting manually:

- 1) Press the **MENU** Key on the PFD to display the PFD Setup Menu Window. 'AUTO' becomes highlighted to the right of 'PFD DSPL'.

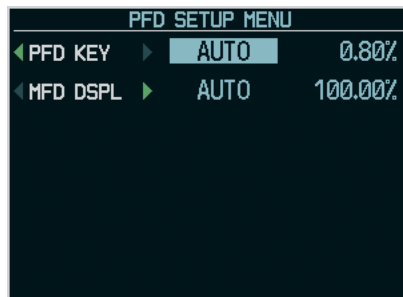

Figure 1-33 Manual Key Lighting Adjustment

- 2) Turn the large **FMS** Knob to highlight 'PFD DSPL'. Turn the small **FMS** Knob in the direction of the green arrowhead to display 'PFD KEY'.
- 3) Turn the large **FMS** Knob to highlight 'AUTO' and turn the small **FMS** Knob to display the selection box.
- 4) Turn the **FMS** Knob to select 'MANUAL', then press the **ENT** Key. The intensity value becomes highlighted.
- 5) Turn the small **FMS** Knob to select the desired backlighting, then press the **ENT** Key.
- 6) Turn the large **FMS** Knob to highlight 'MFD DSPL' and turn the small **FMS** Knob in the direction of the green arrowhead to display 'MFD KEY'.
- 7) Repeat steps 3 to 5.
- 8) Press the **CLR** or **MENU** Key to remove the PFD Setup Menu Window from the display.

SYSTEM OVERVIEW

FLIGHT INSTRUMENTS

EIS

AUDIO PANEL & CNS

FLIGHT MANAGEMENT

HAZARD AVOIDANCE

AFCS

ADDITIONAL FEATURES

APPENDICES

INDEX

BLANK PAGE

SECTION 2 FLIGHT INSTRUMENTS



WARNING: If the airspeed, attitude, altitude, or heading indications become unusable, refer to the backup instruments.



NOTE: The Automatic Flight Control System (AFCS) provides additional readouts and bugs on selected flight instruments. Refer to the AFCS Section for details on these bugs and readouts, as they appear on the display during certain AFCS modes.

Increased situational awareness is provided by replacing the traditional instruments on the panel with an easy-to-scan Primary Flight Display (PFD) that features a large horizon, airspeed, attitude, altitude, vertical speed, and course deviation information. In addition to the flight instruments, navigation, communication, terrain, traffic, and weather information are also presented on the PFD and explained in other sections of this Pilot's Guide.

The following flight instruments and supplemental flight data are displayed on the PFD:

- Airspeed Indicator, showing
 - Indicated airspeed
 - True airspeed
 - Trend vector
 - Airspeed awareness ranges
 - Vspeed reference flags
- Attitude Indicator with slip/skid indication
- Altimeter, showing
 - Trend vector
 - Barometric setting
 - Reference altitude
- Vertical Deviation, Glideslope, and Glidepath Indicators
- Vertical Speed Indicator (VSI)
- Vertical Navigation (VNV) indications
- Outside air temperature (OAT)
- Horizontal Situation Indicator, showing
 - Turn Rate Indicator
 - Bearing pointers and information windows
 - Navigation source
 - Course Deviation Indicator (CDI)
 - DME Information Window
- Transponder Mode, Code, and Ident/Reply
- Timer/References Window, showing
 - Generic timer
 - Vspeed values
 - Barometric Minimum Descent Altitude (MDA)
- Wind data

The PFD also displays various alerts and annunciations.



- | | |
|---------------------------------|--|
| ① NAV Frequency Box | ⑪ Horizontal Situation Indicator (HSI) |
| ② Airspeed Indicator | ⑫ Barometric Altimeter Setting |
| ③ True Airspeed | ⑬ Vertical Speed Indicator (VSI) |
| ④ Current Heading | ⑭ Reference Altitude Bug |
| ⑤ Turn Rate Indicator | ⑮ Altimeter |
| ⑥ Heading Bug | ⑯ Reference Altitude |
| ⑦ Outside Air Temperature (OAT) | ⑰ COM Frequency Box |
| ⑧ Softkeys | ⑱ Navigation Status Box |
| ⑨ System Time | ⑲ Slip/Skid Indicator |
| ⑩ Transponder Data Box | ⑳ Attitude Indicator |

Figure 2-1 Primary Flight Display (Default)



- | | |
|--|------------------------------|
| ① Traffic Annunciation | ⑨ Flight Plan Window |
| ② Vspeed Reference | ⑩ Annunciation Window |
| ③ Selected Heading | ⑪ Selected Course |
| ④ Wind Data | ⑫ Current Vertical Speed |
| ⑤ Inset Map | ⑬ Glideslope Indicator |
| ⑥ DME Information Window | ⑭ Marker Beacon Annunciation |
| ⑦ Bearing Information Windows | ⑮ Terrain Annunciation |
| ⑧ Minimum Descent Altitude/Decision Height | ⑯ AFCS Status Annunciation |

Figure 2-2 Additional PFD Information

2.1 FLIGHT INSTRUMENTS

AIRSPPEED INDICATOR



NOTE: Refer to the Pilot’s Operating Handbook (POH) for airspeed criteria and Vspeed values.

The Airspeed Indicator displays airspeed on a moving tape rolling number gauge. The true airspeed is displayed in knots below the Airspeed Indicator. The numeric labels and major tick marks on the moving tape are shown at intervals of 10 knots. The minor tick marks on the moving tape are shown at intervals of five knots. Speed indication starts at 20 knots, with 60 knots of airspeed viewable at any time. The indicated airspeed is displayed inside the black pointer. The pointer remains black until reaching never-exceed speed (V_{NE}), at which point it turns red.

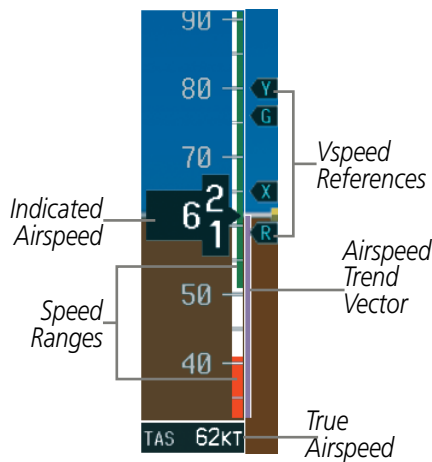

Figure 2-3 Airspeed Indicator (Model 182T)



Figure 2-4 Red Pointer Showing Overspeed (Model 172R)

A color-coded (white, green, yellow, and red) speed range strip is located on the moving tape. The colors denote flaps operating range, normal operating range, caution range, and never-exceed speed (V_{NE}). A red range is also present for low speed awareness.

The Airspeed Trend Vector is a vertical, magenta line that appears to the right of the color-coded speed range strip when airspeed is either accelerating or decelerating. One end of the magenta line is anchored to the tip of the airspeed pointer while the other end moves continuously up or down corresponding to the rate of acceleration or deceleration. For any constant rate of acceleration or deceleration, the moving end of the line shows approximately what the indicated airspeed value will be in six seconds. If the trend vector crosses V_{NE} , the text of the actual airspeed readout changes to yellow. The trend vector is absent if the speed remains constant or if any data needed to calculate airspeed is not available due to a system failure.

Vspeeds (Glide, V_R , V_X , and V_Y) can be changed and their flags turned on/off from the Timer/References Window. When active (on), the Vspeeds are displayed to the right of the airspeed scale.

Changing Vspeeds and turning Vspeed flags on/off:

- 1) Press the **TMR/REF** Softkey.
- 2) Turn the large **FMS** Knob to highlight the field of the desired Vspeed to be changed.
- 3) Use the **FMS** Knob to enter the desired value. When a speed has been changed from a default value, an asterisk appears next to the speed.
- 4) Press the **ENT** Key or turn the large **FMS** Knob to highlight the ON/OFF field.
- 5) Turn the small **FMS** Knob clockwise to ON or counterclockwise to OFF.
- 6) To remove the window, press the **CLR** Key or the **TMR/REF** Softkey.

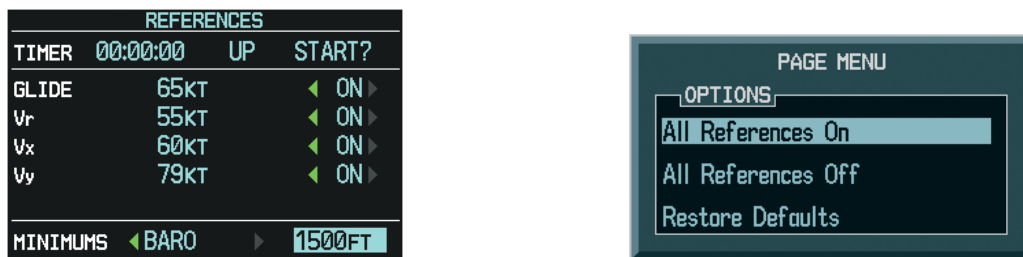

Figure 2-5 Timer/References Window and Menu

Turning all Vspeed flags on/off:

- 1) Press the **TMR/REF** Softkey.
- 2) Press the **MENU** Key.
- 3) To activate all Vspeed flags, press the **ENT** Key with All References On highlighted.
- 4) To remove all Vspeed flags, turn the **FMS** Knob to highlight All References Off and press the **ENT** Key.

Restoring all Vspeed defaults:

- 1) Press the **TMR/REF** Softkey.
- 2) Press the **MENU** Key.
- 3) Turn the **FMS** Knob to highlight Restore Defaults and press the **ENT** Key.

ATTITUDE INDICATOR

Attitude information is displayed over a virtual blue sky and brown ground with a white horizon line. The Attitude Indicator displays the pitch, roll, and slip/skid information.

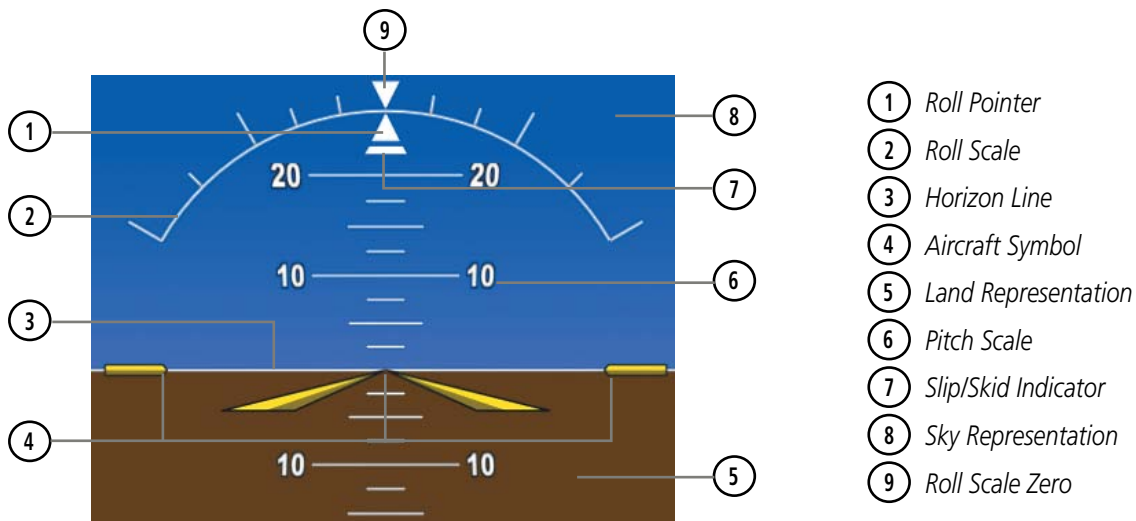

Figure 2-6 Attitude Indicator

The horizon line is part of the pitch scale. Above and below the horizon line, major pitch marks and numeric labels are shown for every 10°, up to 80°. Minor pitch marks are shown for intervening 5° increments, up to 25° below and 45° above the horizon line. Between 20° below to 20° above the horizon line, minor pitch marks occur every 2.5°. If the Synthetic Vision System (optional) is activated, the pitch scale is reduced to 10° up and 7.5° down; refer to the Additional Features section.

The inverted white triangle indicates zero on the roll scale. Major tick marks at 30° and 60° and minor tick marks at 10°, 20°, and 45° are shown to the left and right of the zero. Angle of bank is indicated by the position of the pointer on the roll scale.

The Slip/Skid Indicator is the bar beneath the roll pointer. One bar displacement is equal to one ball displacement on a traditional inclinometer. The indicator bar moves with the roll pointer and moves laterally away from the pointer to indicate uncoordinated flight. Slip (inside the turn) or skid (outside the turn) is indicated by the location of the bar relative to the pointer.



Figure 2-7 Slip/Skid Indication

ALTIMETER

The Altimeter displays 600 feet of barometric altitude values at a time on a moving tape rolling number gauge. Numeric labels and major tick marks are shown at intervals of 100 feet. Minor tick marks are at intervals of 20 feet. The indicated altitude is displayed inside the black pointer.

The Selected Altitude is displayed above the Altimeter in the box indicated by a selection bug symbol. A bug corresponding to this altitude is shown on the tape. If the Selected Altitude exceeds the range shown on the tape, the bug appears at the upper or lower edge of the tape. When the metric value is selected it is displayed in a separate box above the Selected Altitude.

A magenta Altitude Trend Vector extends up or down the left of the altitude tape, the end resting at the approximate altitude to be reached in six seconds at the current vertical speed. The trend vector is not shown if altitude remains constant or if data needed for calculation is not available due to a system failure.

Setting the Selected Altitude:

Turn the **ALT** Knob to set the Selected Altitude (large knob for 1000-ft increments, small knob for 100-ft increments).

If set, the Minimum Descent Altitude/Decision Height (MDA/DH) value is also available for the Selected Altitude.

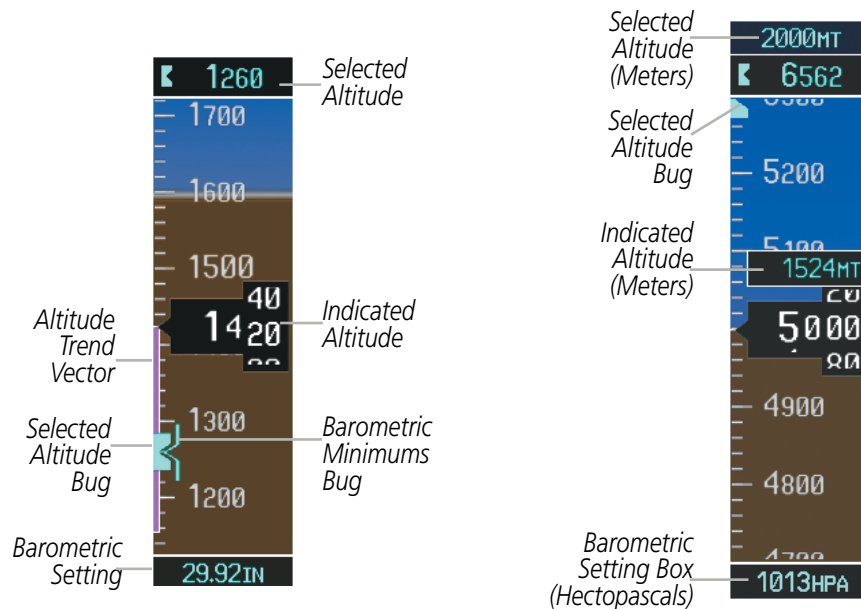

Figure 2-8 Altimeter Settings, In Hg and Metric

Altitudes can also be displayed in meters. Note that the altitude tape does not change scale.

Displaying altitude in meters:

- 1) Press the **PFD** Softkey to display the second-level softkeys.
- 2) Press the **ALT UNIT** Softkey.
- 3) Press the **METERS** Softkey to turn on metric altitude readouts.
- 4) Press the **BACK** Softkey to return to the top-level softkeys.

The barometric pressure setting is displayed below the Altimeter in inches of mercury (in Hg) or hectopascals (hPa) when metric units are selected. Adjusting the altimeter barometric pressure setting creates discontinuities in VNV vertical navigation, moving the descent path. For large adjustments, it may take several minutes for the aircraft to re-establish on the descent patch. If the change is made while nearing a waypoint with a VNV Target Altitude, the aircraft may not re-establish on the descent path in time to meet the vertical constraint.

Selecting the altimeter barometric pressure setting:

Turn the **BARO** Knob to select the desired setting.

Selecting standard barometric pressure:

- 1) Press the **PFD** Softkey to display the second-level softkeys..
- 2) Press the **STD BARO** Softkey; STD BARO is displayed in barometric setting box (Figure 2-9).



Figure 2-9 Standard Barometric Altimeter Setting

Changing altimeter barometric pressure setting units:

- 1) Press the **PFD** Softkey to display the second-level softkeys.
- 2) Press the **ALT UNIT** Softkey.
- 3) Press the **IN** Softkey to display the barometric pressure setting in inches of mercury (in Hg).
Or: Press the **HPA** Softkey to display the barometric pressure setting in hectopascals (hPa).
- 4) Press the **BACK** Softkey to return to the top-level softkeys.

A Baro Transition Alert is provided to notify the pilot to change the barometric pressure setting when crossing the baro transition altitude. If the aircraft is at least 500 feet below the transition altitude and then climbs through this altitude and the **STD BARO** Softkey has not been pressed, the barometric pressure setting flashes in light blue until the pressure setting is changed. If the aircraft is at least 500 feet above the transition altitude and then descends through this altitude and the barometric pressure setting has not been changed from STD BARO, the setting flashes in light blue until it is changed (Figure 2-10).

Setting the Baro Transition Alert:

- 1) Use the **FMS** Knob to select the AUX - System Setup Page.
- 2) Press the **FMS** Knob to activate the cursor.
- 3) Turn the large **FMS** Knob to highlight 'OFF or ON' in the 'BARO TRANSITION ALERT' box.
- 4) Turn the small **FMS** Knob to turn the alert OFF or ON and press the **ENT** Key.
- 5) With the altitude field highlighted, turn the small **FMS** Knob to select the desired altitude and press the **ENT** Key.
- 6) To cancel the selection, press the **FMS** Knob.

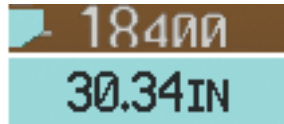

Pressure setting flashes during climb above transition altitude if the STD BARO Softkey has not been pressed.



Pressure setting flashes during descent below transition altitude to indicate setting has not been changed from STD BARO.



Figure 2-10 Baro Transition Alert (AUX - System Setup Page)

VERTICAL SPEED INDICATOR (VSI)

The Vertical Speed Indicator (VSI) displays the aircraft vertical speed on a fixed scale with labels at 1000 and 2000 fpm and minor tick marks every 500 fpm (Figure 2-11). Digits appear in the pointer when the climb or descent rate is greater than 100 fpm. If the rate of ascent/descent exceeds 2000 fpm, the pointer appears at the edge of the tape and the rate appears inside the pointer.

A magenta chevron is displayed as the Required Vertical Speed Indication (RVSI) for reaching a VNV Target Altitude once the “TOD [Top of Descent] within 1 minute” alert has been generated. See the Flight Management and AFCS sections for details on VNV features, and refer to Section 2.2, Supplemental Flight Data, for more information about VNV indications on the PFD.

VERTICAL DEVIATION



NOTE: The Glidepath Indicator is only shown for aircraft with GIA 63W Integrated Avionics Units when SBAS is available.

The Vertical Deviation Indicator (VDI) is a magenta chevron indicating the baro-VNV vertical deviation when Vertical Navigation (VNV) is being used. The VDI appears in conjunction with the “TOD within 1 minute” alert. The VDI is removed from the display if vertical deviation becomes invalid. See the Flight Management Section for details on VNV features, and refer to Section 2.2, Supplemental Flight Data, for more information about VNV indications on the PFD.

The Glideslope Indicator appears to the left of the Altimeter whenever an ILS frequency is tuned in the active NAV field and the aircraft heading and selected course are within 107°. A green diamond acts as the Glideslope Indicator, like a glideslope needle on a conventional indicator. If a localizer frequency is tuned and there is no glideslope, “NO GS” is displayed in place of the diamond.

The glidepath is analogous to the glideslope for GPS approaches supporting SBAS vertical guidance (LNAV+V, L/VNAV, LPV). When an approach of this type is loaded into the flight plan and GPS is the selected navigation source, the Glidepath Indicator appears as a magenta diamond during the approach. If the approach type downgrades past the final approach fix (FAF), “NO GP” is displayed in place of the diamond.

Full-scale deflection of two dots is 1000 feet.

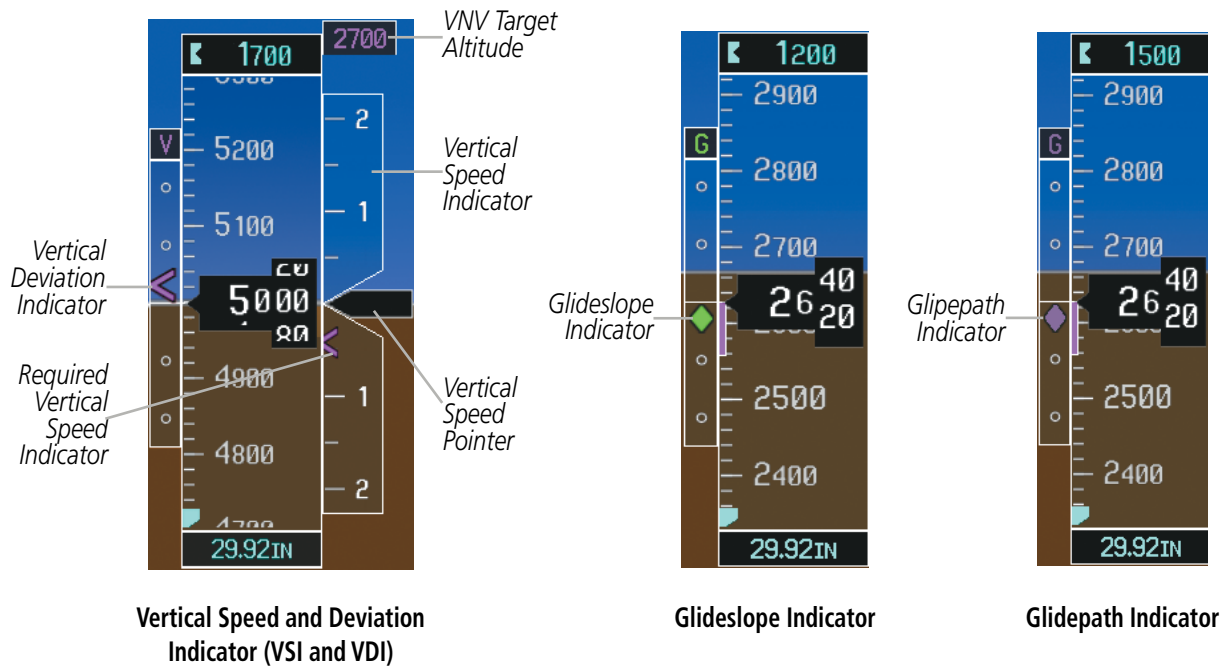

Figure 2-11 Vertical Speed and Vertical Deviation Indications

HORIZONTAL SITUATION INDICATOR (HSI)

The Horizontal Situation Indicator (HSI) displays a rotating compass card in a heading-up orientation. Letters indicate the cardinal points with numeric labels every 30°. Major tick marks are at 10° intervals and minor tick marks are at 5° intervals. A digital reading of the current heading appears on top of the HSI, and the current track is represented on the HSI by a magenta diamond. The HSI also presents turn rate, course deviation, bearing, and navigation source information. The HSI is available in two formats, a 360° compass rose and a 140° arc.

Changing the HSI display format:

- 1) Press the **PFD Softkey**
- 2) Press the **HSI FRMT Softkey**.
- 3) Press the **360 HSI** or **ARC HSI** Softkey.

The 360° HSI contains a Course Deviation Indicator (CDI), with a Course Pointer, To/From Indicator, and a sliding deviation bar and scale. The course pointer is a single line arrow (GPS, VOR1, and LOC1) or a double line arrow (VOR2 and LOC2) which points in the direction of the set course. The To/From arrow rotates with the course pointer and is displayed when the active NAVAID is received.

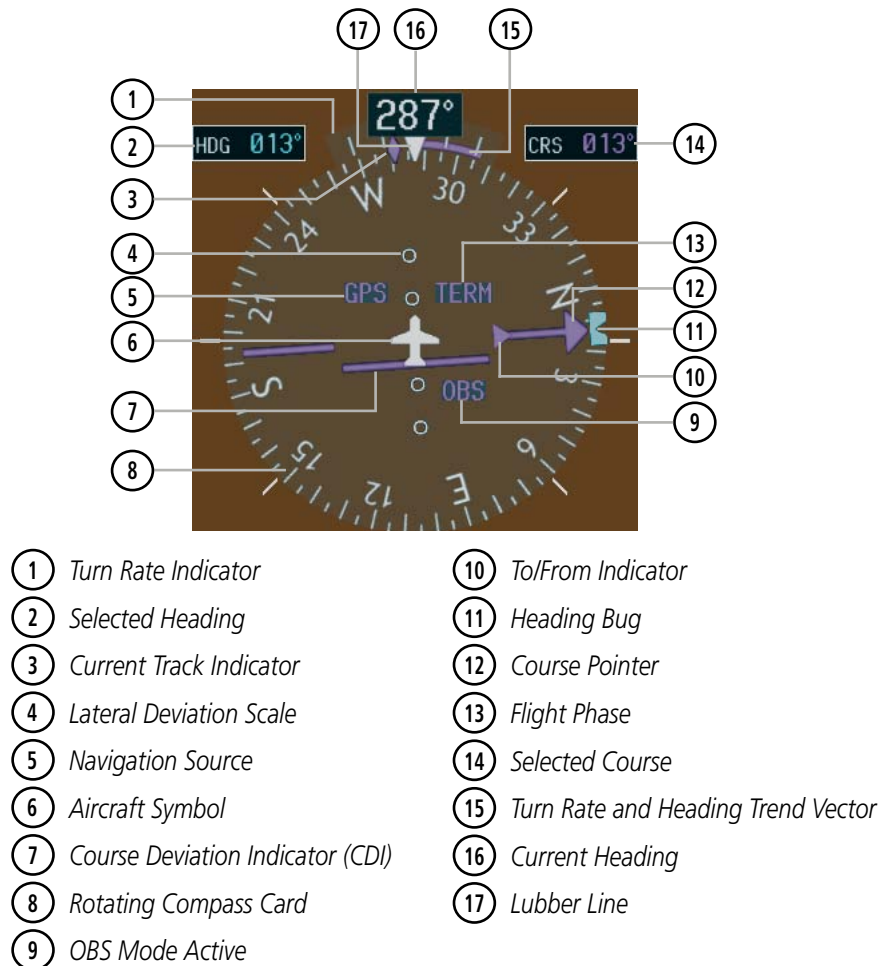

Figure 2-12 Horizontal Situation Indicator (360° HSI)

The Arc HSI is a 140° expanded section of the compass rose. The Arc HSI contains a Course Pointer, combined To/From Indicator and a sliding deviation indicator, and a deviation scale. Upon station passage, the To/From Indicator flips and points to the tail of the aircraft, just like a conventional To/From flag. Depending on the navigation source, the CDI on the Arc HSI can appear in two different ways, an arrowhead (GPS, VOR, OBS) or a diamond (LOC).

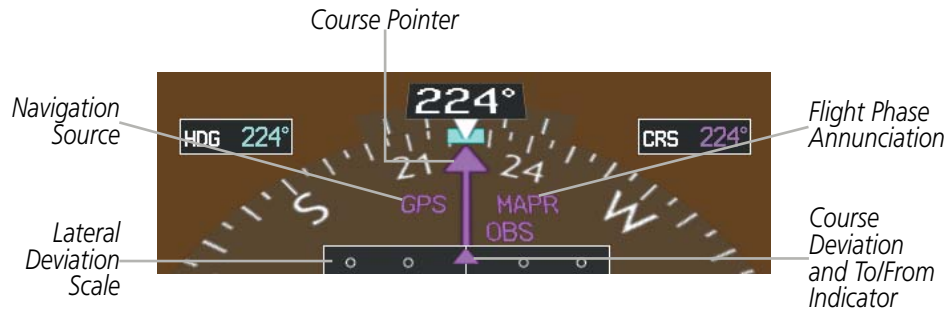

Figure 2-13 Arc HSI

The selected heading is shown to the upper left of the HSI and is displayed in light blue. The light blue heading bug on the compass rose corresponds to the selected heading.

Adjusting the selected heading:

Turn the **HDG** Knob to set the selected heading.

Press the **HDG** Knob to synchronize the bug to the current heading.

The Selected Course is shown to the upper right of the HSI. The color of the Selected Course corresponds to the selected navigation source: magenta for GPS or green for NAV (VOR, LOC).

Adjusting the Selected Course:

Turn the **CRS** Knob to set the Selected Course.

Press the **CRS** Knob to re-center the CDI and return the course pointer to the bearing of the active waypoint or navigation station (see OBS Mode for adjusting a GPS course).



Figure 2-14 Heading and Course Indications (Magnetic)

Navigation angles (track, heading, course, bearing) are corrected to the computed magnetic variation (Mag Var) or referenced to true north (T), set on the AUX - System Setup Page. When an approach referenced to true north has been loaded into the flight plan, the system generates a message to change the navigation angle setting to True at the appropriate time.



Figure 2-15 Heading and Course Indications (True)

Changing the navigation angle true/magnetic setting:

- 1) Use the **FMS** Knob to select the AUX - System Setup Page on the MFD.
- 2) Press the **FMS** Knob to activate the cursor.
- 3) Turn the large **FMS** Knob to highlight Nav Angle in the Display Units box.
- 4) Turn the small **FMS** Knob to highlight the desired setting and press the **ENT** Key.
 - TRUE - References angles to true north (T)
 - MAGNETIC - Angles corrected to the computed magnetic variation (Mag Var)



Figure 2-16 Navigation Angle Settings (AUX - System Setup Page)

TURN RATE INDICATOR

The Turn Rate Indicator is located directly above the rotating compass card. Tick marks to the left and right of the lubber line denote half-standard and standard turn rates. A magenta Turn Rate Trend Vector shows the current turn rate. The end of the trend vector gives the heading predicted in 6 seconds, based on the present turn rate. A standard-rate turn is shown on the indicator by the trend vector stopping at the standard turn rate tick mark, corresponding to a predicted heading of 18° from the current heading. At rates greater than 4 deg/sec, an arrowhead appears at the end of the magenta trend vector and the prediction is no longer valid.



Figure 2-17 Turn Rate Indicator and Trend Vector

BEARING POINTERS AND INFORMATION WINDOWS

Two bearing pointers and associated information can be displayed on the HSI for NAV, GPS, and ADF sources by pressing the **PFD** Softkey then a **BRG** or **DME** Softkey. The bearing pointers are light blue and are single-line (BRG1) or double-line (BRG2). A pointer symbol is shown in the information windows to indicate the navigation source. The bearing pointers never override the CDI and are visually separated from the CDI by a white ring. Bearing pointers may be selected but not necessarily visible due to data unavailability. When the Arc HSI is displayed, the Bearing Information windows and pointers are disabled.

NOTE: ADF radio installation is optional.

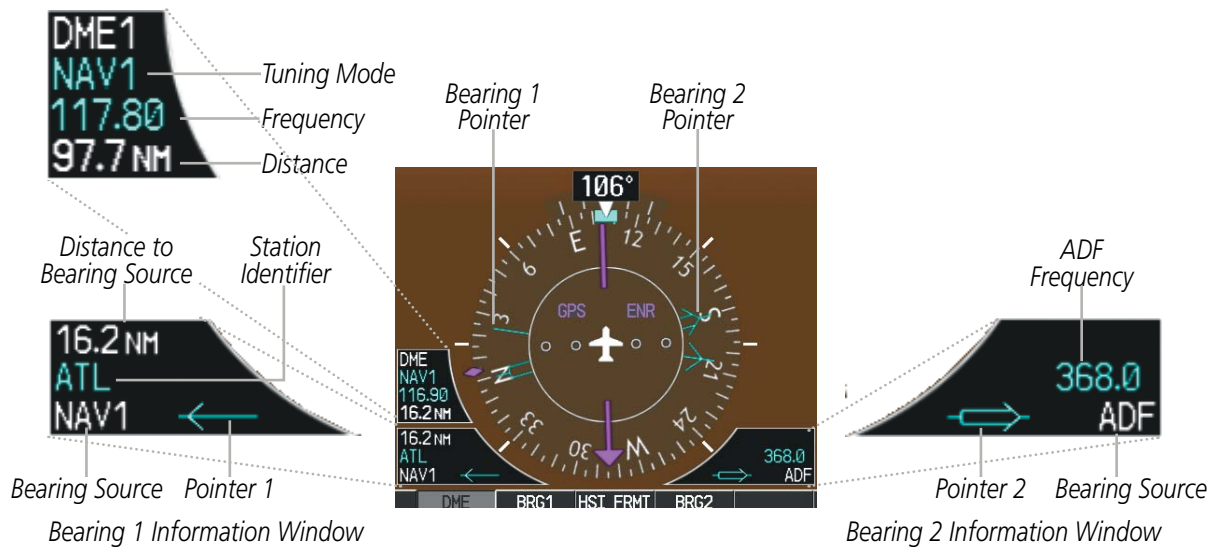

Figure 2-18 HSI with Bearing and Distance Information

When a bearing pointer is displayed, the associated information window is also displayed. The Bearing Information Windows (Figure 2-18) are displayed at the lower sides of the HSI and give the following information:

- Bearing source (NAV, GPS, ADF)
- Pointer icon (BRG1 = single line, BRG2 = double line)
- Frequency (NAV, ADF)
- Station/waypoint identifier (NAV, GPS)
- GPS-derived great circle distance to bearing source

When the NAV radio is tuned to an ILS frequency the bearing source and the bearing pointer is removed from the HSI. When NAV1 or NAV2 is the selected bearing source, the frequency is replaced by the station identifier when the station is within range. If GPS is the bearing source, the active waypoint identifier is displayed instead of a frequency.

The bearing pointer is removed from the HSI and NO DATA is displayed in the information window if the NAV radio is not receiving a VOR station or if GPS is the bearing source and an active waypoint is not selected.

Selecting bearing display and changing sources:

- 1) Press the **PFD** Softkey.
- 2) Press a **BRG** Softkey to display the desired bearing pointer and information window with a NAV source.
- 3) Press the **BRG** Softkey again to change the bearing source to GPS.
- 4) To remove the bearing pointer and information window, press the **BRG** Softkey again.

DME INFORMATION WINDOW

The DME Information Window is displayed above the BRG1 Information Window on the 360° HSI and in a box above and along side the Arc HSI. It shows the DME label, tuning mode (NAV1, NAV2, or HOLD), frequency, and distance. When a signal is invalid, the distance is replaced by –. – NM Refer to the Audio Panel and CNS Section for information on tuning the DME.



NOTE: DME installation is optional.

Displaying the DME Information Window:

- 1) Press the **PFD** Softkey.
- 2) Press the **DME** Softkey to display the DME Information Window.
- 3) To remove the DME Information Window, press the **DME** Softkey again.

COURSE DEVIATION INDICATOR (CDI)

NOTE: During a heading change of greater than 105° with respect to the course, the CDI on the Arc HSI switches to the opposite side of the deviation scale and displays reverse sensing.

The Course Deviation Indicator (CDI) moves left or right from the course pointer along a lateral deviation scale to display aircraft position relative to the course. If the course deviation data is not valid, the CDI is not displayed.

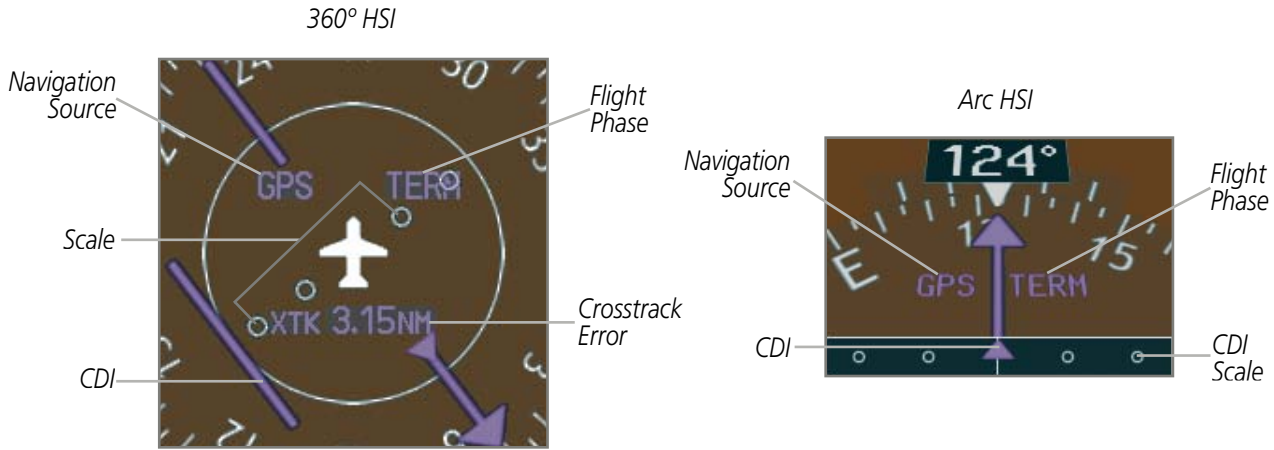

Figure 2-19 Course Deviation Indicator

The CDI can display two sources of navigation, GPS or VOR/LOC. The color indicates the current navigation source, magenta for GPS and green for VOR and LOC. The full scale limits for the CDI are defined by a GPS-derived distance when navigating GPS. When navigating using a VOR or localizer (LOC), the CDI uses the same angular deviation as a mechanical CDI. If the CDI exceeds the maximum deviation on the scale (two dots) while navigating with GPS, the crosstrack error (XTK) is displayed below the white aircraft symbol.

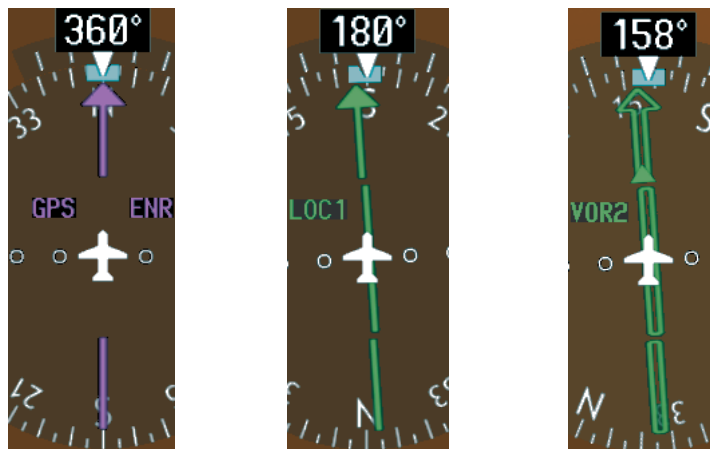

Figure 2-20 Navigation Sources

Changing navigation sources:

- 1) Press the **CDI** Softkey to change from GPS to VOR1 or LOC1. This places the light blue tuning box over the NAV1 standby frequency in the upper left corner of the PFD.
- 2) Press the **CDI** Softkey again to change from VOR1 or LOC1 to VOR2 or LOC2. This places the light blue tuning box over the NAV2 standby frequency.
- 3) Press the **CDI** Softkey a third time to return to GPS.

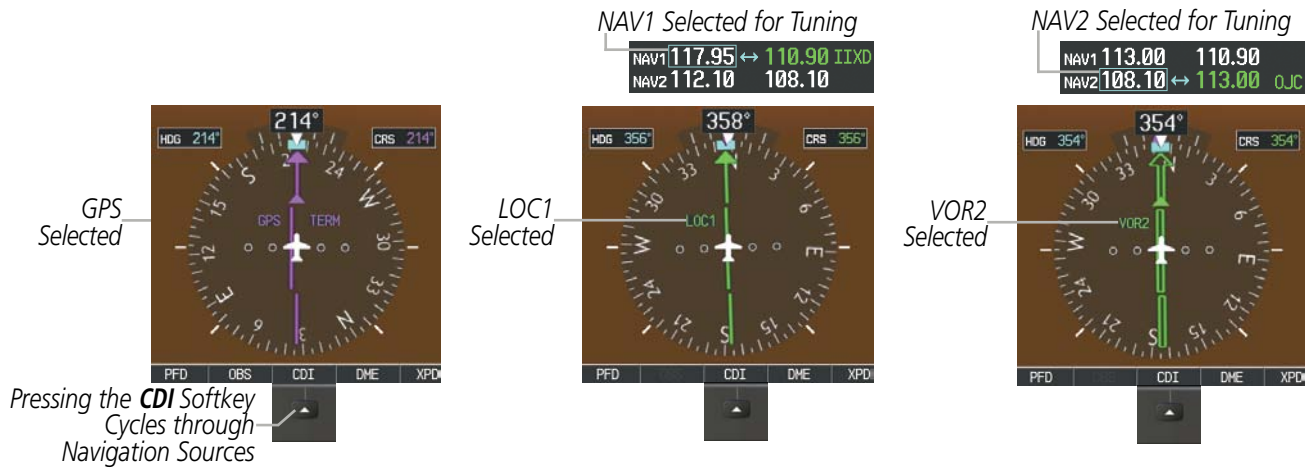

Figure 2-21 Selecting a Navigation Source

The system automatically switches from GPS to LOC navigation source and changes the CDI scaling accordingly when all of the following occur:

- A localizer or ILS approach has been loaded into the active flight plan
- The final approach fix (FAF) is the active leg, the FAF is less than 15 nm away, and the aircraft is moving toward the FAF
- A valid localizer frequency has been tuned
- The GPS CDI deviation is less than 1.2 times full-scale deflection

GPS steering guidance is still provided after the CDI automatically switches to LOC until LOC capture, up to the Final Approach Fix (FAF) for an ILS approach, or until GPS information becomes invalid. Activating a Vector-to-Final (VTF) also causes the CDI to switch to LOC navigation source. GPS steering guidance is not provided after the switch.

GPS CDI SCALING

When GPS is the selected navigation source, the flight plan legs are sequenced automatically and annunciations appear on the HSI for the flight phase. Flight phase annunciations are normally shown in magenta, but when cautionary conditions exist the color changes to yellow. If the current leg in the flight plan is a heading leg, HDG LEG is annunciated in magenta beneath the aircraft symbol.

The current GPS CDI scale setting is displayed as System CDI on the AUX - System Setup Page and the full-scale deflection setting may also be changed (2.0 nm, 1.0 nm, 0.3 nm, or Auto) from this page. If the selected scaling is smaller than the automatic setting for enroute and terminal phases, the CDI is scaled accordingly and the selected setting is displayed rather than the flight phase annunciation.

Changing the selected GPS CDI setting:

- 1) Use the **FMS** Knob to select the AUX - System Setup Page on the MFD.
- 2) Press the **FMS** Knob to activate the cursor.
- 3) Turn the large **FMS** Knob to highlight Selected in the GPS CDI box.
- 4) Turn the small **FMS** Knob to highlight the desired setting and press the **ENT** Key.
- 5) To cancel the selection, press the **FMS** Knob or the **CLR** Key.



Figure 2-22 GPS CDI Settings (AUX - System Setup Page)

When set to Auto (default), the GPS CDI scale automatically adjusts to the desired limits based upon the current phase of flight (Figure 2-23, Table 2-1).

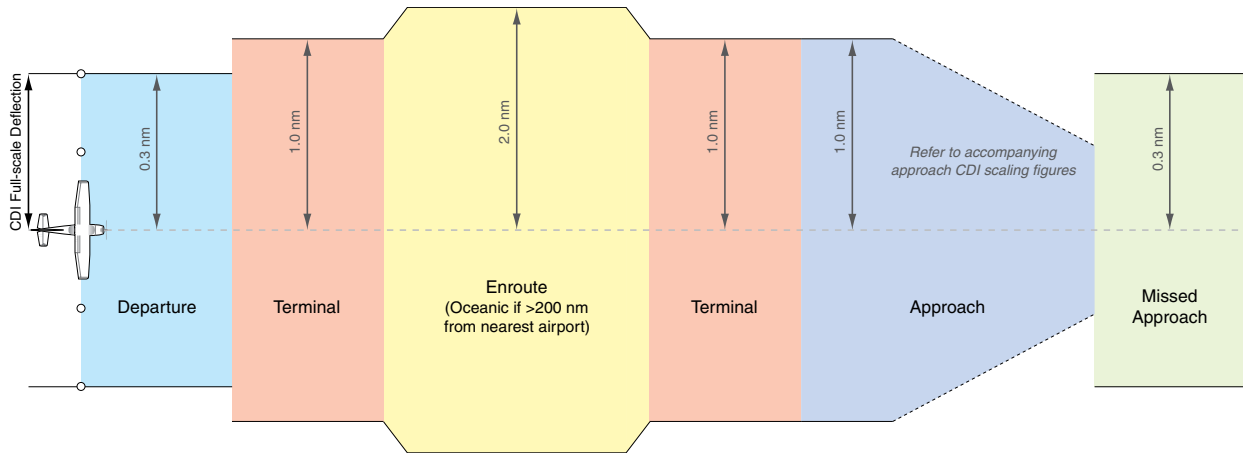

Figure 2-23 Automatic CDI Scaling

- Once a departure procedure is activated, the CDI is scaled for **departure** (0.3 nm).
- The system switches from departure to **terminal** CDI scaling (1.0 nm) under the following conditions:
 - The next leg in the departure procedure is not aligned with the departure runway
 - The next leg in the departure procedure is not a CA, CD, CF, CI, CR, DF, FA, FC, FD, FM, IF, or TF (see Glossary for leg type definitions)
 - After any leg in the departure procedure that is not a CA or FA
- At 30 nm from the departure airport, the **enroute** phase of flight is automatically entered and CDI scaling changes to 2.0 nm over a distance of 1.0 nm, except under the following conditions:
 - When navigating with an active departure procedure, the flight phase and CDI scale does not change until the aircraft arrives at the last departure waypoint (if more than 30 nm from the departure airport) or the leg after the last departure waypoint has been activated or a direct-to waypoint is activated.
- If after completing the departure procedure the nearest airport is more than 200 nm away from the aircraft and the approach procedure has not yet commenced, the CDI is scaled for **oceanic** flight (2.0 nm).
- Within 31 nm of the destination airport (**terminal** area), the CDI scale gradually ramps down from 2.0 nm to 1.0 nm over a distance of 1.0 nm; except under the following conditions:
 - Upon reaching the first waypoint of an arrival route that is more than 31 nm from the destination airport, the flight phase changes to terminal and the CDI scale begins to transition down from 2.0 nm to 1.0 nm over a distance of 1.0 nm.
- During **approach**, the CDI scale ramps down even further (Figures 2-24 and 2-25). This transition normally occurs within 2.0 nm of the final approach fix (FAF). The CDI switches to approach scaling automatically once the approach procedure is activated or if Vectors-To-Final (VTF) are selected.
 - If the active waypoint is the FAF, the ground track and the bearing to the FAF must be within 45° of the final approach segment course.
 - If the active waypoint is part of the missed approach procedure, the active leg and the preceding missed approach legs must be aligned with the final approach segment course and the aircraft must not have passed the turn initiation point.

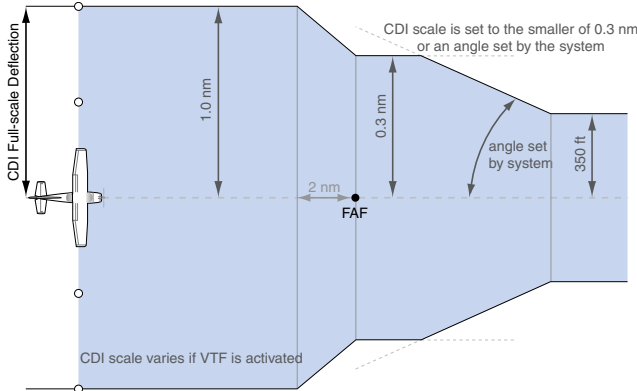

Figure 2-24 Typical LNAV and LNAV+V Approach CDI Scaling

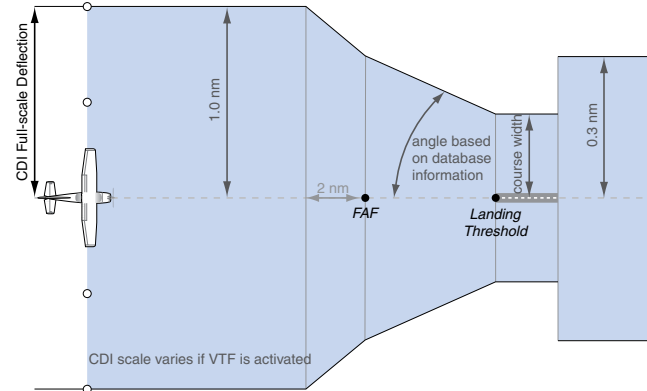

Figure 2-25 Typical LNAV/VNAV and LPV Approach CDI Scaling

- When a **missed approach** is activated, the CDI scale changes to 0.3 nm.
- The system automatically switches back to **terminal** mode under the following conditions:
 - The next leg in the missed approach procedure is not aligned with the final approach path
 - The next leg in the missed approach procedure is not a CA, CD, CF, CI, CR, DF, FA, FC, FD, FM, IF, or TF
 - After any leg in the missed approach procedure that is not a CA or FA

Flight Phase	Annunciation*	Automatic CDI Full-scale Deflection
Departure	DPRT	0.3 nm
Terminal	TERM	1.0 nm
Enroute	ENR	2.0 nm
Oceanic	OCN	2.0 nm
Approach (Non-precision)	LNAV	1.0 nm decreasing to 350 feet depending on variables (Figure 2-24)
Approach (Non-precision with Vertical Guidance)	LNAV + V	
Approach (LNAV/VNAV)	L/VNAV	1.0 nm decreasing to a specified course width, then 0.3 nm, depending on variables (Figure 2-25)
Approach (LPV)	LPV	
Missed Approach	MAPR	0.3 nm

* Flight phase annunciations are normally shown in magenta, but when cautionary conditions exist the color changes to yellow.

Table 2-1 Automatic GPS CDI Scaling

OBS MODE



NOTE: VNV is inhibited while automatic waypoint sequencing has been suspended.

Enabling Omni-bearing Selector (OBS) Mode suspends the automatic sequencing of waypoints in a GPS flight plan (GPS must be the selected navigation source), but retains the current Active-to waypoint as the navigation reference even after passing the waypoint. OBS is annunciated to the lower right of the aircraft symbol on the moving map when OBS Mode is selected.

While OBS is enabled, a course line is drawn through the active-to waypoint on the moving map. If desired, the course to/from the waypoint can now be adjusted. When OBS Mode is disabled, the GPS flight plan returns to normal operation, with automatic sequencing of waypoints, following the course set in OBS Mode. The flight plan on the moving map retains the modified course line.

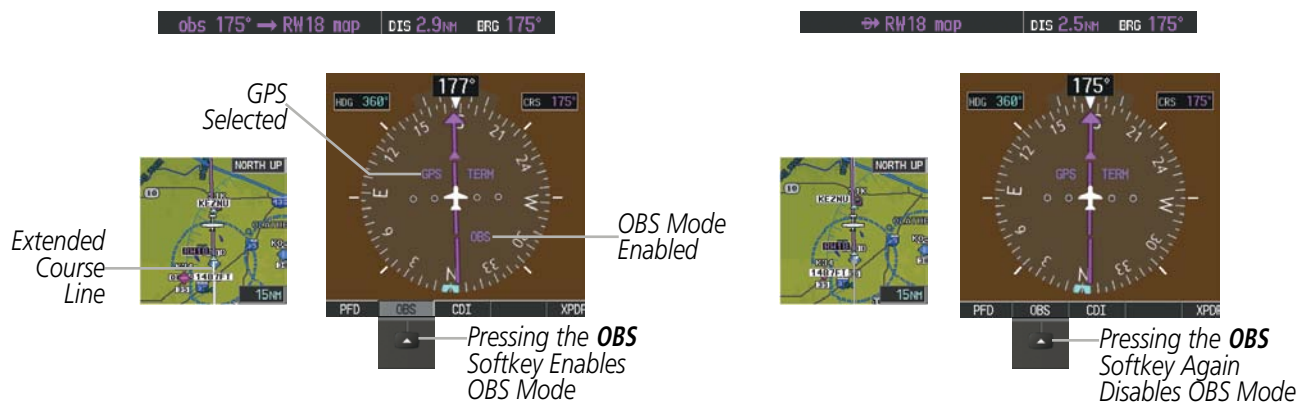

Figure 2-26 Omni-bearing Selector (OBS) Mode

Enabling/disabling OBS Mode while navigating a GPS flight plan:

- 1) Press the **OBS** Softkey to select OBS Mode.
- 2) Turn the **CRS** Knob to select the desired course to/from the waypoint. Press the **CRS** Knob to synchronize the Selected Course with the bearing to the next waypoint.
- 3) Press the **OBS** Softkey again to return to automatic waypoint sequencing.

As the aircraft crosses the missed approach point (MAP), automatic approach waypoint sequencing is suspended. **SUSP** appears on the HSI at the lower right of the aircraft symbol. The **OBS** Softkey label changes to indicate the suspension is active as shown in Figure 2-27. Pressing the **SUSP** Softkey, deactivates the suspension and resumes automatic sequencing of approach waypoints.

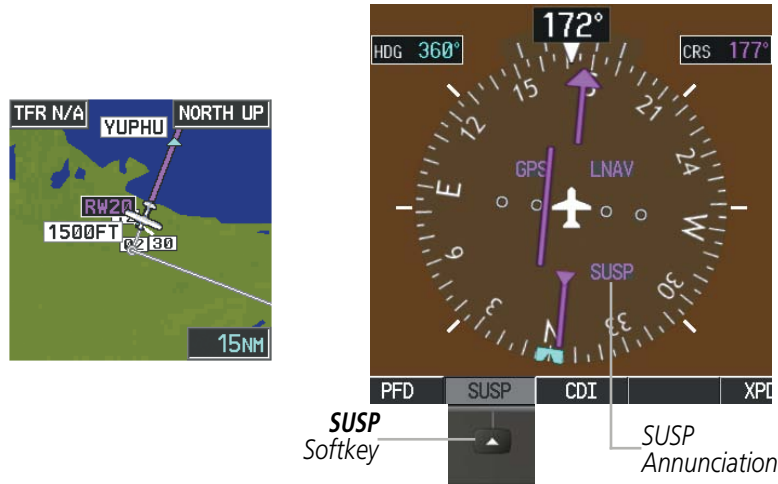

Figure 2-27 Suspending Automatic Waypoint Sequencing

- SYSTEM OVERVIEW
- FLIGHT INSTRUMENTS
- EIS
- AUDIO PANEL & CNS
- FLIGHT MANAGEMENT
- HAZARD AVOIDANCE
- AFCS
- ADDITIONAL FEATURES
- APPENDICES
- INDEX

2.2 SUPPLEMENTAL FLIGHT DATA



NOTE: Pressing the *DFLTS* Softkey turns off metric Altimeter display, the Inset Map and wind data display.

In addition to the flight instruments, the PFD also displays various supplemental information, including temperatures, wind data, and Vertical Navigation (VNV) indications.

OUTSIDE AIR TEMPERATURE

The Outside Air Temperature (OAT) is displayed in degrees Celsius (°C) or Fahrenheit (°F) as selected by the pilot, in the lower left of the PFD under normal display conditions. Temperature is displayed below the true airspeed in reversionary mode.

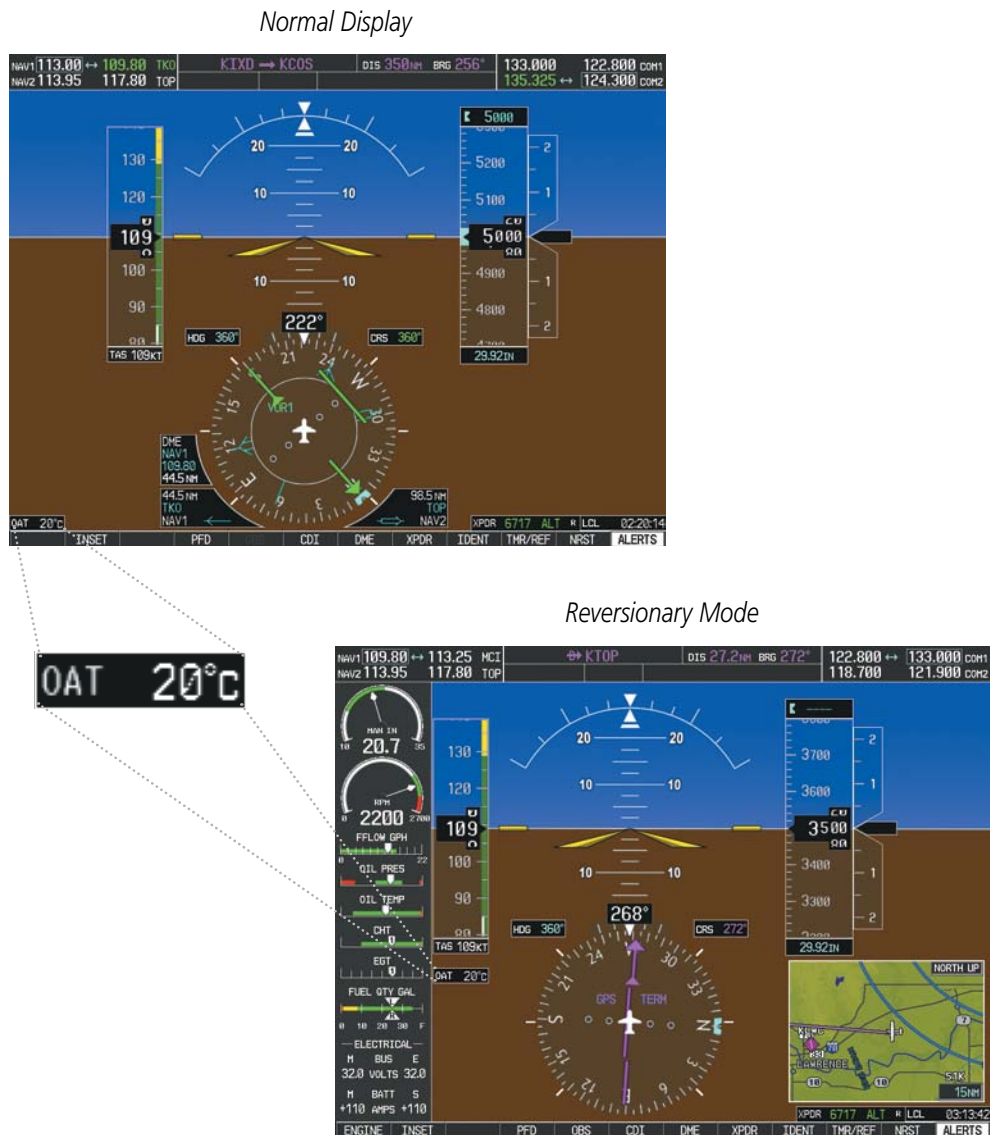

Figure 2-28 Outside Air Temperature

Changing temperature display units:

- 1) Select the AUX - System Setup Page on the MFD using the **FMS** Knob.
- 2) Press the **FMS** Knob to activate the cursor.
- 3) Turn the large **FMS** Knob to highlight the TEMP field in the Display Units box.
- 4) Turn the small **FMS** Knob to highlight either CELSIUS or FAHRENHEIT and press the **ENT** Key to confirm the selection.
- 5) To cancel the selection, press the **FMS** Knob or the **CLR** Key.



Figure 2-29 Temperature Selection (AUX - System Setup Page)

WIND DATA

Wind direction and speed in knots can be displayed relative to the aircraft in a window to the upper left of the HSI. When the window is selected for display, but wind information is invalid or unavailable, the window displays NO WIND DATA. Wind data can be displayed in three different ways.

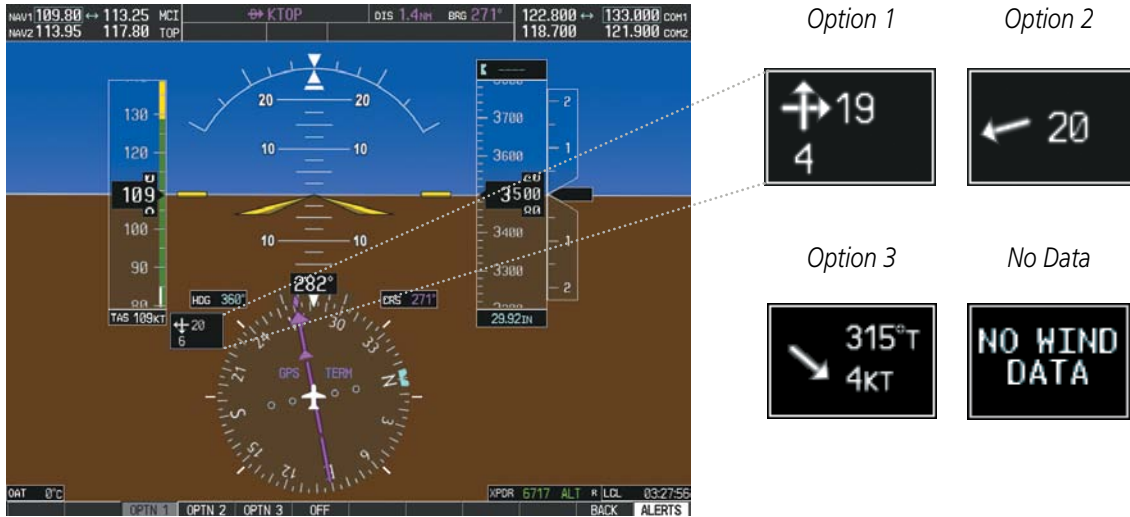

Figure 2-30 Wind Data

Displaying wind data:

- 1) Press the **PFD** Softkey.
- 2) Press the **WIND** Softkey to display wind data below the selected heading.
- 3) Press one of the **OPTN** softkeys to change how wind data is displayed:
 - **OPTN 1**: Wind direction arrows with headwind/tailwind and crosswind components
 - **OPTN 2**: Wind direction arrow and numeric speed
 - **OPTN 3**: Wind direction arrow with numeric True direction and numeric speed
- 4) To remove the window, press the **OFF** Softkey.

VERTICAL NAVIGATION (VNV) INDICATIONS

When a VNV flight plan has been activated, VNV indications (VNV Target Altitude, RVSI, VDI) appear on the PFD in conjunction with the “TOD within 1 minute” message and “Vertical track” voice alert. See the Flight Management and AFCS sections for details on VNV features. VNV indications are removed from the PFD according to the criteria listed in the Table 2-2.



Figure 2-31 Vertical Navigation Indications

Criteria	VNV Indication Removed		
	Required Vertical Speed (RVSI)	Vertical Deviation (VDI)	VNV Target Altitude*
Aircraft > 1 min before the next TOD due to flight plan change	X	X	X
VNV cancelled (CNCL VNV Softkey pressed on MFD)	X	X	X
Distance to active waypoint cannot be computed due to unsupported flight plan leg type (see Flight Management Section)	X	X	X
Aircraft > 250 feet below active VNV Target Altitude	X	X	X
Current crosstrack or track angle error has exceeded limit	X	X	X
Active altitude-constrained waypoint can not be reached within maximum allowed flight path angle and vertical speed	X	X	

Table 2-2 VNV Indication Removal Criteria

2.3 PFD ANNUNCIATIONS AND ALERTING FUNCTIONS

The following annunciations and alerting functions are displayed on the PFD. Refer to Appendix A for more information on alerts and annunciations.

SYSTEM ALERTING

Messages appear in the Alerts Window in the lower right corner of the PFD when a warning, caution, advisory alert, or system message advisory occurs. System alert messages are provided for awareness of system problems or status and may or may not require pilot action. The Alerts Window allows system alerts to be displayed simultaneously. The **FMS** Knob is used to scroll through the alert messages. The Alerts Window is enabled/disabled by pressing the **ALERTS** Softkey. If the window is already open when a new message is generated, pressing the **ALERTS** Softkey to acknowledge the message turns the softkey gray.

The **ALERTS** Softkey label changes to display the appropriate annunciation when an alert is issued. The annunciation flashes and the appropriate aural alert sounds until acknowledged by pressing the softkey. The softkey then reverts to the **ALERTS** Softkey label, and when pressed again opens the Alerts Window to display a descriptive message of the alert.

The Annunciation Window appears to the right of the Vertical Speed Indicator and displays abbreviated annunciation text for aircraft alerts. Warnings appear in red, cautions in yellow, advisory alerts in white, and safe operating annunciations in green. New alerts are displayed at the top of the Annunciation Window, regardless of priority. Once acknowledged, they are sequenced based on priority.

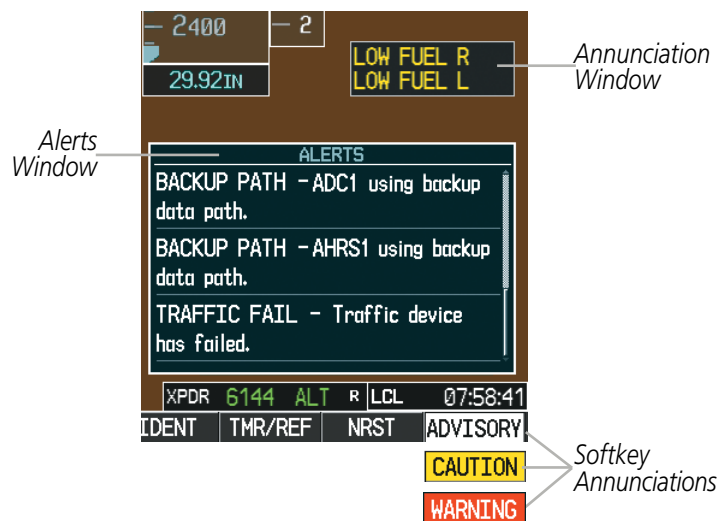

Figure 2-32 System Alerting

MARKER BEACON ANNUNCIATIONS

Marker Beacon Annunciations are displayed on the PFD to the left of the Selected Altitude. Outer marker reception is indicated in blue, middle in yellow, and inner in white. Refer to the Audio Panel and CNS Section for more information on Marker Beacon Annunciations.

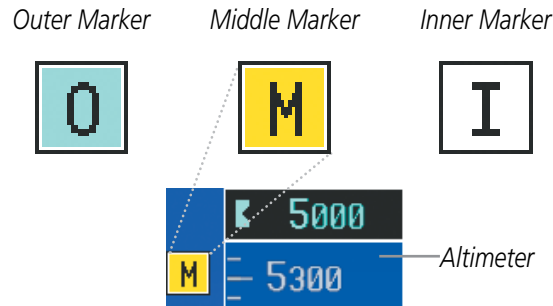

Figure 2-33 Marker Beacon Annunciations

TRAFFIC ANNUNCIATION

Traffic is displayed symbolically on the PFD Inset Map, the MFD Navigation Map Page, and various other MFD page maps. Refer to the Hazard Avoidance Section and the Appendix for more details about the Traffic Information Service (TIS) and optional Traffic Advisory Systems (TAS). When a traffic advisory (TA) is detected, the following automatically occur:

- The PFD Inset Map is enabled and displays traffic
- A flashing black-on-yellow TRAFFIC annunciation appears to the top left of the Attitude Indicator for five seconds and remains displayed until no TAs are detected in the area
- A single “TRAFFIC” aural alert is heard, unless an optional Traffic Advisory System (TAS) is installed. Refer to the applicable TAS documentation for alerts generated by TAS equipment.

If additional TAs appear, new aural and visual alerts are generated.

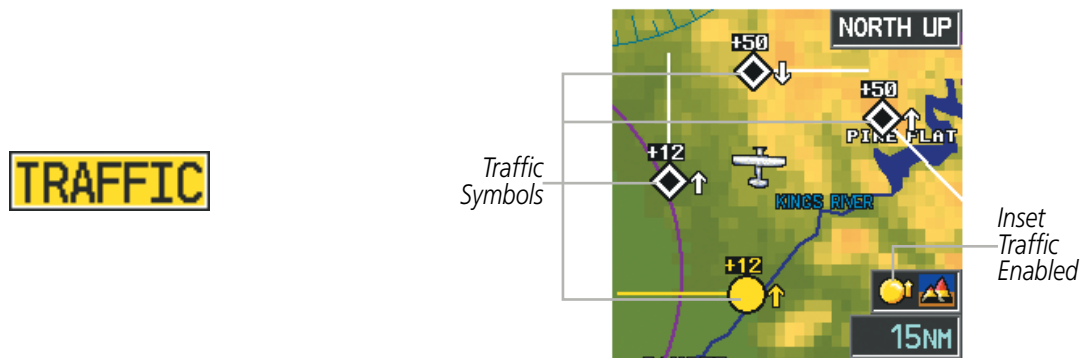

Figure 2-34 Traffic Annunciation and Inset Map with TIS Traffic Displayed

TAWS ANNUNCIATIONS

Terrain Awareness and Warning System (TAWS) annunciations appear on the PFD at the top left of the Altimeter. Refer to the Hazard Avoidance Section and Appendix A for information on TAWS alerts and annunciations.



Figure 2-35 Traffic and TAWS Annunciations

ALTITUDE ALERTING

Altitude Alerting provides the pilot with a visual alert when approaching the Selected Altitude. Whenever the Selected Altitude is changed, the Altitude Alerter is reset. Altitude alerting tones and visual alerts occur only if the GFC 700 is installed. The following occur when approaching the Selected Altitude:

- Upon passing through 1000 feet of the Selected Altitude an aural tone is heard. The Selected Altitude changes to black text on a light blue background and flashes for 5 seconds.
- When the aircraft passes within 200 feet of the Selected Altitude, the Selected Altitude changes to light blue text on a black background and flashes for 5 seconds.
- After reaching the Selected Altitude, if the pilot flies outside the deviation band (± 200 feet of the Selected Altitude) an aural tone is heard. The Selected Altitude changes to yellow text on a black background and flashes for 5 seconds.



Figure 2-36 Altitude Alerting Visual Annunciations

LOW ALTITUDE ANNUNCIATION



NOTE: A Low Altitude Annunciation is available only when SBAS is available. This annunciation is not shown for systems with TAWS, unless TAWS is inhibited.

When the Final Approach Fix (FAF) is the active waypoint in a GPS SBAS approach using vertical guidance, a Low Altitude Annunciation may appear if the current aircraft altitude is at least 164 feet below the prescribed altitude at the FAF. A black-on-yellow LOW ALT annunciation appears to the top left of the Altimeter, flashing for several seconds, then remaining displayed until the condition is resolved.



Figure 2-37 Low Altitude on GPS SBAS Approach

MINIMUM DESCENT ALTITUDE/DECISION HEIGHT ALERTING

For altitude awareness, a barometric Minimum Descent Altitude (MDA) or Decision Height (DH) can be set in the Timer/References Window and is reset when the power is cycled. When active, the altitude setting is displayed to the bottom left of the Altimeter. Once the altitude is within the range of the tape, a bug appears at the reference altitude on the Altimeter. The following visual annunciations occur when approaching the MDA/DH:

- When the aircraft altitude descends to within 2500 feet of the MDA/DH setting, the BARO MIN box appears with the altitude in light blue text. The bug appears on the altitude tape in light blue once in range.
- When the aircraft passes through 100 feet of the MDA/DH, the bug and text turn white.
- Once the aircraft reaches MDA/DH, the bug and text turn yellow and the aural alert, “Minimums. Minimums”, is heard.

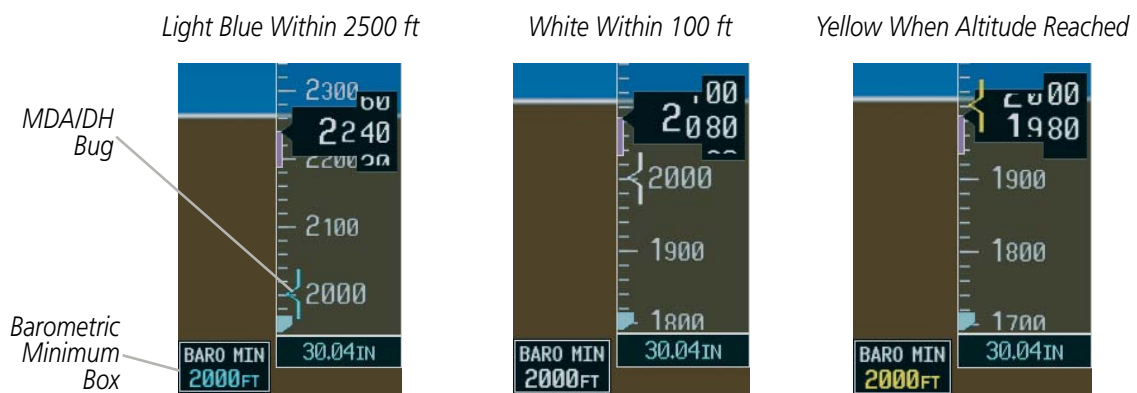

Figure 2-38 Barometric MDA/DH Alerting Visual Annunciations

Setting the barometric Minimum Descent Altitude/Decision Height and bug:

- 1) Press the **TMR/REF** Softkey.
- 2) Turn the large **FMS** Knob to highlight the Minimums field.
- 3) Turn the small **FMS** Knob to select BARO. Off is selected by default. Press the **ENT** Key or turn the large **FMS** Knob to highlight the next field.
- 4) Use the small **FMS** Knob to enter the desired altitude from zero to 16,000 feet.
- 5) To remove the window, press the **CLR** Key or the **TMR/REF** Softkey.



Figure 2-39 MDA/DH Setting (Timer/References Window)

Alerting is inhibited while the aircraft is on the ground and until the aircraft reaches 150 feet above the MDA/DH. If the aircraft proceeds to climb after having reached the MDA/DH, once it reaches 50 feet above the MDA/DH, alerting is disabled.

2.4 ABNORMAL OPERATIONS

ABNORMAL GPS CONDITIONS

The annunciations listed in Table 2-3 can appear on the HSI when abnormal GPS conditions occur. Refer to the Flight Management Section for more information on Dead Reckoning Mode.

Annunciation	Location	Description
LOI	Lower left of aircraft symbol	Loss of Integrity Monitoring—GPS integrity is insufficient for the current phase of flight
INTEG OK	Lower left of aircraft symbol	Integrity OK—GPS integrity has been restored to within normal limits (annunciation displayed for 5 seconds)
DR	Upper right of aircraft symbol	Dead Reckoning—System is using projected position rather than GPS position to compute navigation data and sequence active flight plan waypoints

Table 2-3 Abnormal GPS Conditions Annunciated on HSI



Figure 2-40 Example HSI Annunciations

Dead Reckoning (DR) Mode causes the following items on the PFD to be shown in yellow when GPS is the selected navigation source during Enroute (ENR) or Oceanic (OCN) phases of flight:

- CDI (removed after 20 minutes)
- Current Track Bug
- Wind Data
- Distances in the Bearing Information Windows
- GPS bearing pointers
- Ground Speed

It is important to note that estimated navigation data supplied by the G1000 in DR Mode may become increasingly unreliable and must not be used as a sole means of navigation. See the Flight Management section for more information about DR mode

UNUSUAL ATTITUDES

When the aircraft enters an unusual pitch attitude, red chevrons pointing toward the horizon warn of extreme pitch. The chevrons are displayed on the Attitude Indicator, starting at 50° above and 30° below the horizon line.

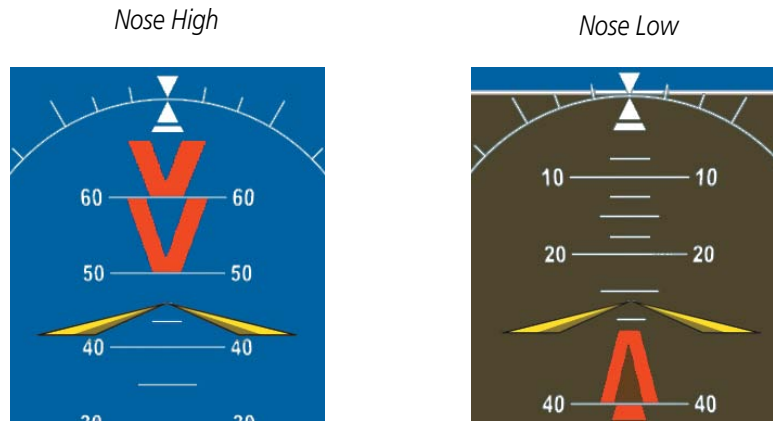

Figure 2-41 Pitch Attitude Warnings

If pitch exceeds +30°/-20° or bank exceeds 65°, some information displayed on the PFD is removed. The Altimeter and Airspeed, Attitude, Vertical Speed, and Horizontal Situation indicators remain on the display and the Bearing Information, Alerts, and Annunciation windows can be displayed during such situations. The following information is removed from the PFD and their softkeys are disabled when the aircraft experiences unusual attitudes:

- | | | |
|---|---|---|
| <ul style="list-style-type: none"> • Traffic Annunciations • AFCS Annunciations • Flight Director Command Bars • Inset Map • Outside Air Temperature (OAT) • Wind Data • Selected Heading Readout • Selected Course Readout • PFD Setup Menu | <ul style="list-style-type: none"> • Windows displayed in the lower right corner of the PFD: <ul style="list-style-type: none"> – Timer/References – Nearest Airports – Flight Plan – Alerts – Procedures • Minimum Descent Altitude/ Decision Height Readout | <ul style="list-style-type: none"> • Vertical Deviation, Glideslope, and Glidepath Indicators • Altimeter Barometric Setting • Selected Altitude • VNV Target Altitude • System Time • Transponder Status Box |
|---|---|---|

SYSTEM
OVERVIEW

**FLIGHT
INSTRUMENTS**

EIS

AUDIO PANEL
& CNS

FLIGHT
MANAGEMENT

HAZARD
AVOIDANCE

AFCS

ADDITIONAL
FEATURES

APPENDICES

INDEX

BLANK PAGE

SECTION 3 ENGINE INDICATION SYSTEM (EIS)

NOTE: Refer to the Pilot's Operating Handbook (POH) for limitations.

The Engine Indication System (EIS) displays critical engine, electrical, fuel, and other system parameters on the left side of the Multi Function Display (MFD) during normal operations (Figure 3-1). In reversionary mode (Figure 3-2), the displays are re-configured to present Primary Flight Display (PFD) symbology together with the EIS (refer to the System Overview for information about Reversionary Mode).



Figure 3-1 Multi Function Display (172S Normal Operations)



Figure 3-2 Primary Flight Display (182T Reversionary Mode)

Green bands on the instruments indicate normal ranges of operation; yellow and red bands indicate caution and warning, respectively. White bands indicate areas outside of normal operation not yet in the caution or warning ranges. When unsafe operating conditions occur, readouts, pointers and labels change color corresponding to the level of the condition; warnings also flash. If sensory data to an instrument becomes invalid or unavailable, a red "X" is shown across the instrument.

EIS information is presented in three displays, accessed using the **ENGINE** Softkey on the MFD. 172R, 172S, 182T, 206H, T182T, and T206H display the following:

- **Engine Display** – Default display, shows all critical engine, fuel, and electrical indicators
- **Lean Display** – Provides engine leaning information
- **System Display** – Shows numeric readouts of critical engine, fuel, and electrical indicators

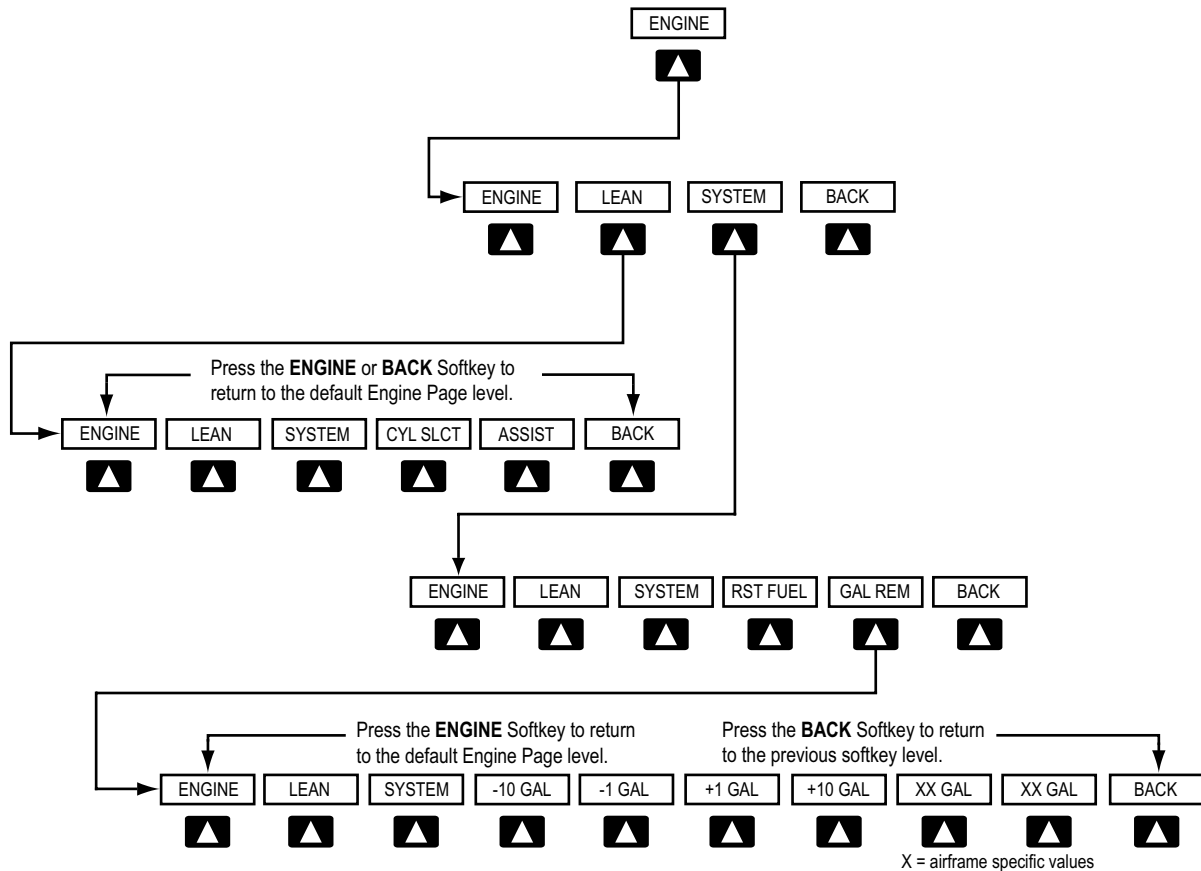

Figure 3-3 Engine Softkey Flowchart

3.1 ENGINE DISPLAY

The Engine Display is the default EIS display and can be displayed after viewing other EIS displays by pressing the **ENGINE** softkey. This display shows the dial gauge(s), horizontal bar indicators, and readouts for critical engine and electrical parameters.

The EIS automatically defaults back to the Engine Display from the Lean or System Display when certain parameters are exceeded. Fluctuations in engine speed and fuel quantity above certain levels, depending on the airframe, also cause reversion back to the Engine Display.

NORMALLY-ASPIRATED AND TURBOCHARGED AIRCRAFT

- | | |
|--|--|
| <p>① Engine Manifold Pressure Gauge (MAN IN)
<i>Models 182T, T182T, 206H, T206H</i></p> | <p>Displays engine power in inches of mercury (in Hg)
<i>Turbocharged aircraft</i> – Red range indicates maximum manifold pressure
<i>Model T182T</i> – A white tick mark indicates the cruise manifold pressure</p> |
| <p>② Tachometer (RPM)</p> | <p>Displays propeller speeds in revolutions per minute (rpm)
Red range indicates propeller overspeed warning
<i>Models 172S, 206H, and T206H</i> – White high-rpm range indicates above normal operating speeds
<i>Model 172S</i> – When ascending through 5300 ft, the upper end of the green arc displays 2600 rpm and ascending through 10,300 displays 2700 rpm. When descending below 9700 ft, the upper end of the green arc returns to 2600 rpm and descending below 4700 ft returns to 2500 rpm (Figure 3-6)</p> |
| <p>③ Fuel Flow Indicator (FFLOW GPH)</p> | <p>Displays the current fuel flow in gallons per hour (gph)
<i>Turbocharged aircraft</i> – A green tick mark indicates maximum takeoff fuel flow
<i>Model T182T</i> – A white tick mark indicates the maximum cruise fuel flow</p> |
| <p>④ Oil Pressure Indicator (OIL PRES)</p> | <p>Displays pressure of the oil supplied to the engine in pounds per square inch (psi)</p> |
| <p>⑤ Oil Temperature Indicator (OIL TEMP)</p> | <p>Displays the engine oil temperature in degrees Fahrenheit (°F)</p> |
| <p>⑥ Cylinder Head Temperature Indicator (CHT)
<i>Models 182T, T182T, 206H, T206H</i></p> | <p>Displays the head temperature of the hottest cylinder (number shown in triangular pointer) in °F</p> |
| <p>⑦ Exhaust Gas Temperature Indicator (EGT)
<i>Normally-aspirated Aircraft</i></p> | <p>Displays the exhaust gas temperature of the hottest cylinder (number shown in triangular pointer) in °F</p> |
| <p>⑧ Turbine Inlet Temperature Indicator (TIT)
<i>Turbocharged Aircraft</i></p> | <p>Displays the temperature at the turbine inlet in °F</p> |

- ⑨ **Vacuum Pressure Indicator (VAC)** Displays standby vacuum pump pressure
Models 172R and 172S
- ⑩ **Fuel Quantity Indicator (FUEL QTY GAL)** Displays the quantity of fuel in gallons (gal) in each tank (left–L and right–R) from zero to full (F)
When full, the indicator displays to 35 gal per side (24 gal for *Models 172R and 172S*)
- ⑪ **Engine Hours (Tach) (ENG HRS)** Displays a numeric readout for the time in hours (hrs) the engine has been in service
Models 172R and 172S
- ⑫ **Voltmeter (M, E BUS VOLTS)** Displays the main and essential bus voltages
- ⑬ **Ammeter (M, S BATT AMPS)** Displays the main and standby battery load in amperes

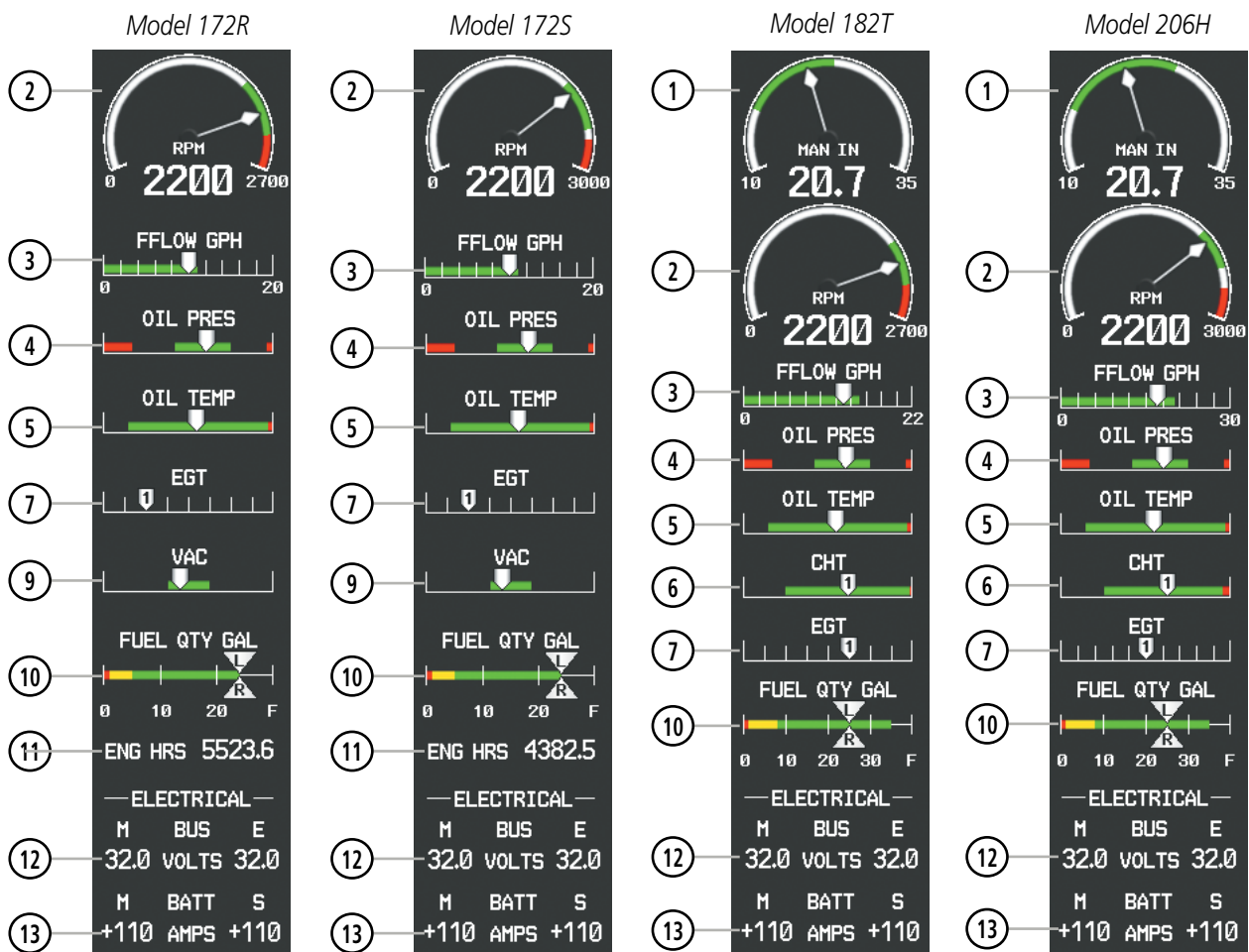

Figure 3-4 Engine Display (Normally-Aspirated Aircraft)

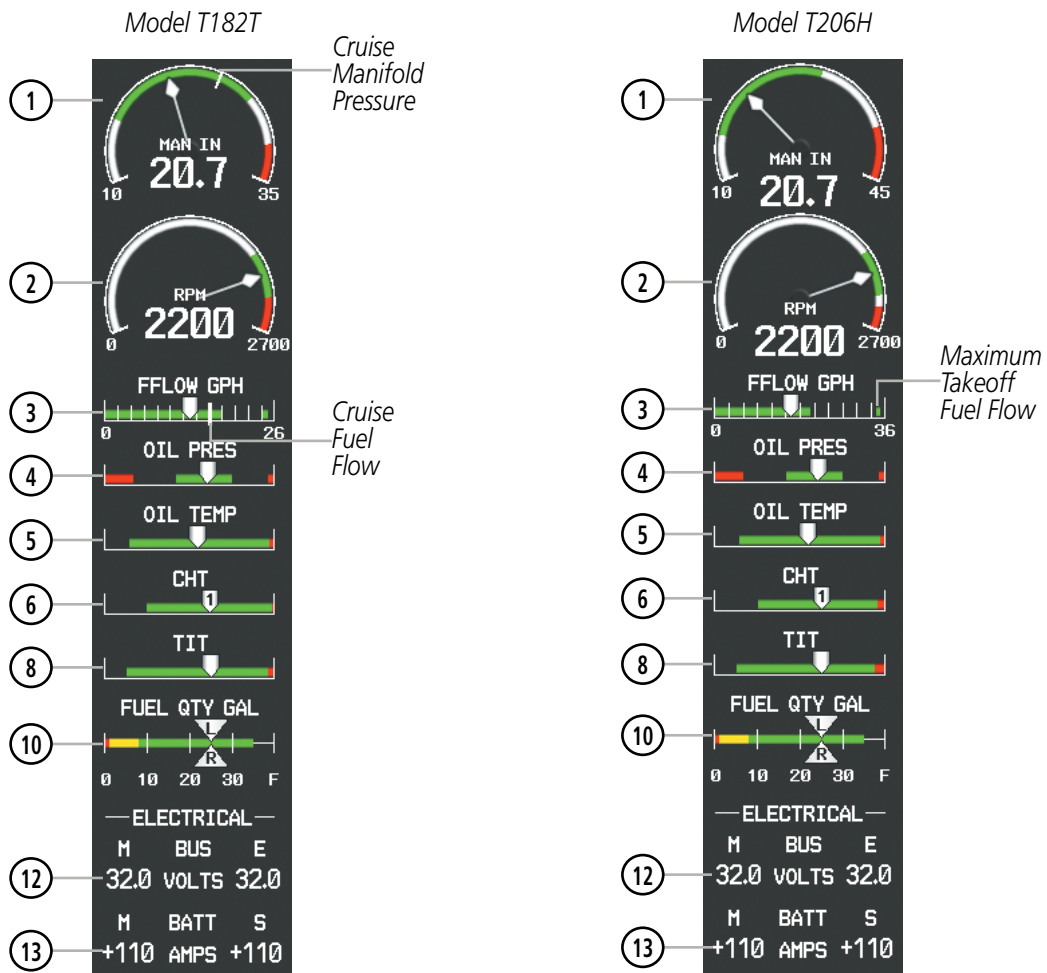

Figure 3-5 Engine Display (Turbocharged Aircraft)

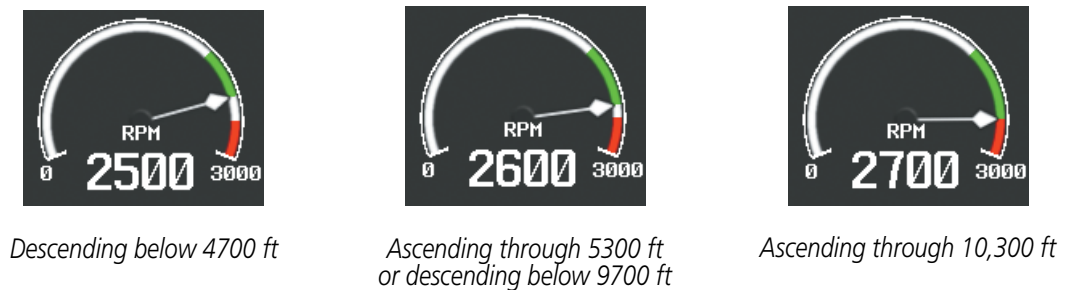

Figure 3-6 172S Tachometer Green Arc Expansion

3.2 LEAN DISPLAY



NOTE: The pilot should follow the engine manufacturer's recommended leaning procedures in the Pilot's Operating Handbook (POH).

The Lean Display is accessed by pressing the **ENGINE** Softkey followed by the **LEAN** Softkey and provides information for performing engine leaning. The engine gauge(s) and Fuel Quantity Indicator remain on the Lean Display and fuel flow is listed as a numeric readout. Exhaust gas (EGT) and cylinder head (CHT) temperatures for all cylinders are displayed graphically with numeric readouts for the selected cylinder. For turbocharged aircraft, the Turbine Inlet Temperature (TIT) Indicator is shown above the EGT Bar Graph.

Accessing the EIS Lean Display:

- 1) Press the **ENGINE** Softkey.
- 2) Press the **LEAN** Softkey.
- 3) To return to the default Engine Display, press the **ENGINE** or **BACK** Softkey.

From the Lean Display, the pilot can use the **CYL SLCT** and **ASSIST** softkeys to get information about specific cylinders. Pressing the **CYL SLCT** (Cylinder Select) Softkey cycles through the cylinders (i.e., changes the cylinder number indicated on the bar graphs in light blue). This softkey is disabled when the **ASSIST** Softkey is pressed or when a cylinder experiences a caution or warning condition; the softkey remains disabled until the temperature returns to normal.

Monitoring the desired cylinder's EGT and CHT:

From the Lean Display, press the **CYL SLCT** Softkey to cycle through each cylinder and view its EGT and CHT. The selected cylinder number is shown in light blue.

The **ASSIST** Softkey aids in the leaning process by identifying the peak of the first cylinder whose temperature falls. This cylinder's number below the EGT bar graph is highlighted in light blue as the selected cylinder. If the temperature of the peaked cylinder exceeds the peak value, the peak value is not updated. Monitoring of the cylinder continues until the **ASSIST** Softkey is pressed again which disables lean assist, and removes the peak block from the bar graph and the temperature deviation from peak (Δ PEAK). The system then returns to seeking the hottest cylinder.

- ① **Engine Manifold Pressure Gauge (MAN IN)**
Models 182T, T182T, 206H, T206H

Displays engine power in inches of mercury (in Hg)
Turbocharged aircraft – Red range indicates maximum manifold pressure
Model T182T – A white tick mark indicates the cruise manifold pressure
- ② **Tachometer (RPM)**

Displays propeller speeds in revolutions per minute (rpm)
 Red range indicates propeller overspeed warning
Models 172S, 206H, and T206H – White high-rpm range indicates above normal operating speeds
Model 172S – When ascending through 5300 ft, the upper end of the green arc displays 2600 rpm and ascending through 10,300 displays 2700 rpm. When descending below 9700 ft, the upper end of the green arc returns to 2600 rpm and descending below 4700 ft returns to 2500 rpm (Figure 3-6)
- ③ **Fuel Flow (FFLOW GPH)**

Displays the current fuel flow in gallons per hour (gph)
- ④ **Turbine Inlet Temperature Indicator (TIT)**
Turbocharged Aircraft

Displays the temperature at the turbine inlet in degrees Fahrenheit (°F)
 TIT deviation from peak (Δ PEAK) is displayed below the indicator when the **ASSIST** Softkey is pressed.
- ⑤ **Exhaust Gas Temperature Bar Graph (EGT °F)**

Displays the exhaust gas temperature of all cylinders in °F; a readout for the selected cylinder (by default, the hottest cylinder) is shown below the bar graph
 The selected cylinder is indicated in light blue. Cylinders whose EGTs are in the normal range appear in white.
 The EGT deviation from peak (Δ PEAK) for the selected cylinder is displayed below the indicator when the **ASSIST** Softkey is pressed.
- ⑥ **Cylinder Head Temperature Bar Graph (CHT)**

Displays the head temperatures of all cylinders in °F; a readout for the selected cylinder (by default, the hottest cylinder) is shown below the bar graph
 The selected cylinder number is indicated in light blue. Cylinder whose CHTs are in the normal range appear in white. Cylinders whose CHTs enter the warning range appear in red.
- ⑦ **Fuel Quantity Indicator (FUEL QTY GAL)**

Displays the quantity of fuel in gallons (gal) in each tank (left–L and right–R)
 When full, the indicator displays to 35 gal per side (24 gal for *Models 172R and 172S*).

SYSTEM OVERVIEW

FLIGHT INSTRUMENTS

EIS

AUDIO PANEL & CNS

FLIGHT MANAGEMENT

HAZARD AVOIDANCE

AFCS

ADDITIONAL FEATURES

APPENDICES

INDEX

NORMALLY-ASPIRATED AIRCRAFT

For normally-aspirated aircraft, when a cylinder peaks, its peak is represented by a light blue block on the EGT Bar Graph. The EGT readout for the peaked cylinder number, indicated on the bar graph in light blue, appears directly beneath the bar graph. The system automatically switches to the first peak obtained and displays the temperature deviation from peak (Δ PEAK) in degrees Fahrenheit ($^{\circ}$ F) below the EGT readout.

Selecting the Engine Leaning Assist function:

From the Lean Display, press the **ASSIST** Softkey to identify the peak. The peak temperature for the selected cylinder is indicated with a blue block on the EGT Bar Graph and the temperature deviation from peak is shown underneath the EGT Bar Graph.

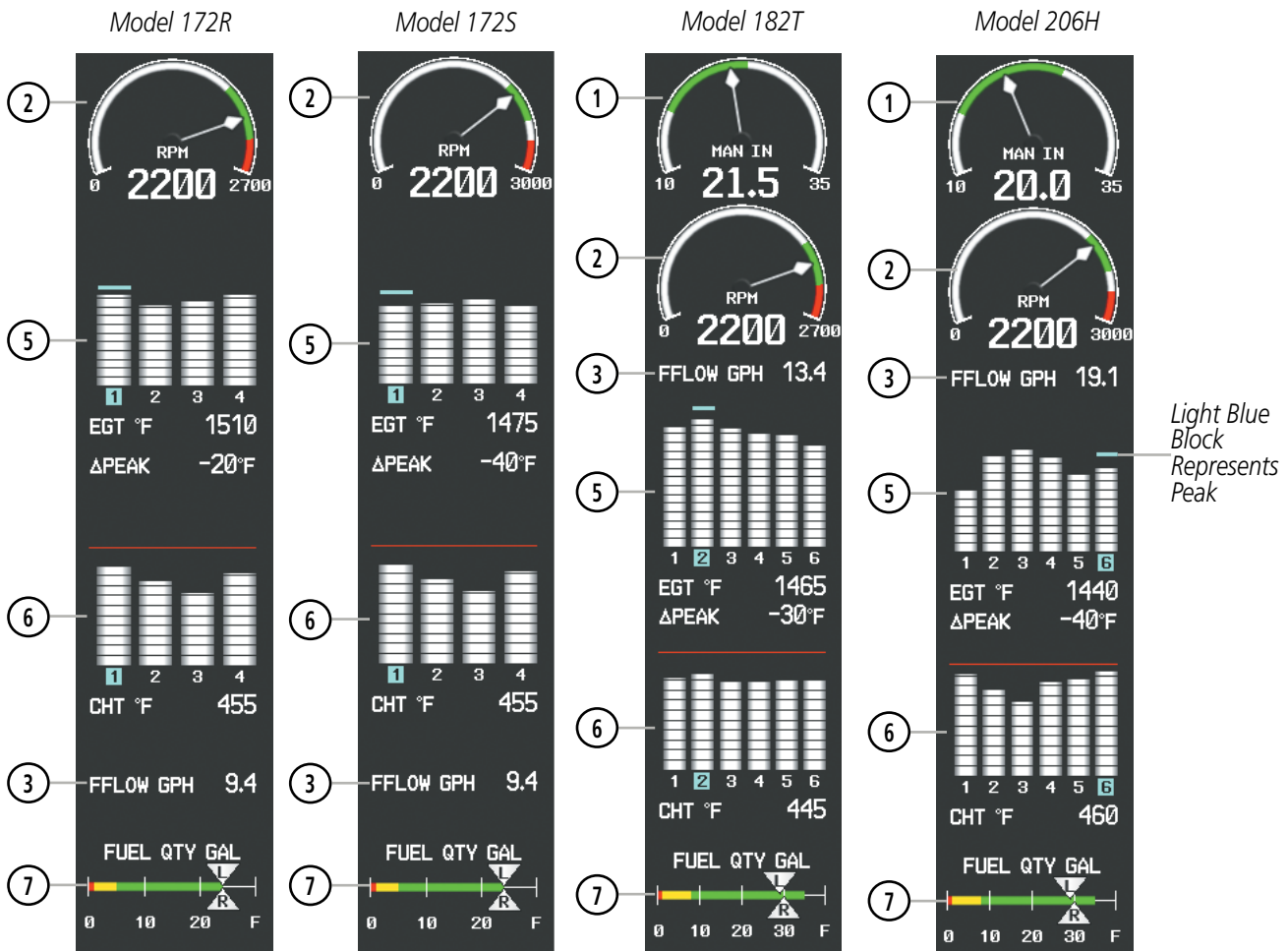

Figure 3-7 Lean Display (Normally-Aspirated Aircraft)

TURBOCHARGED AIRCRAFT

Leaning for turbocharged aircraft is done with reference to the Turbine Inlet Temperature (TIT). When the temperature peaks, the numeric readout (Δ PEAK) appears below the TIT Indicator and displays the difference between peak and current TITs, in degrees Fahrenheit (°F). If a peak is not displayed, underscores are shown until one is established.

Selecting the Engine Leaning Assist function:

From the Lean Display, press the **ASSIST** Softkey to identify the peak. The TIT deviation from peak is shown below the TIT Indicator.

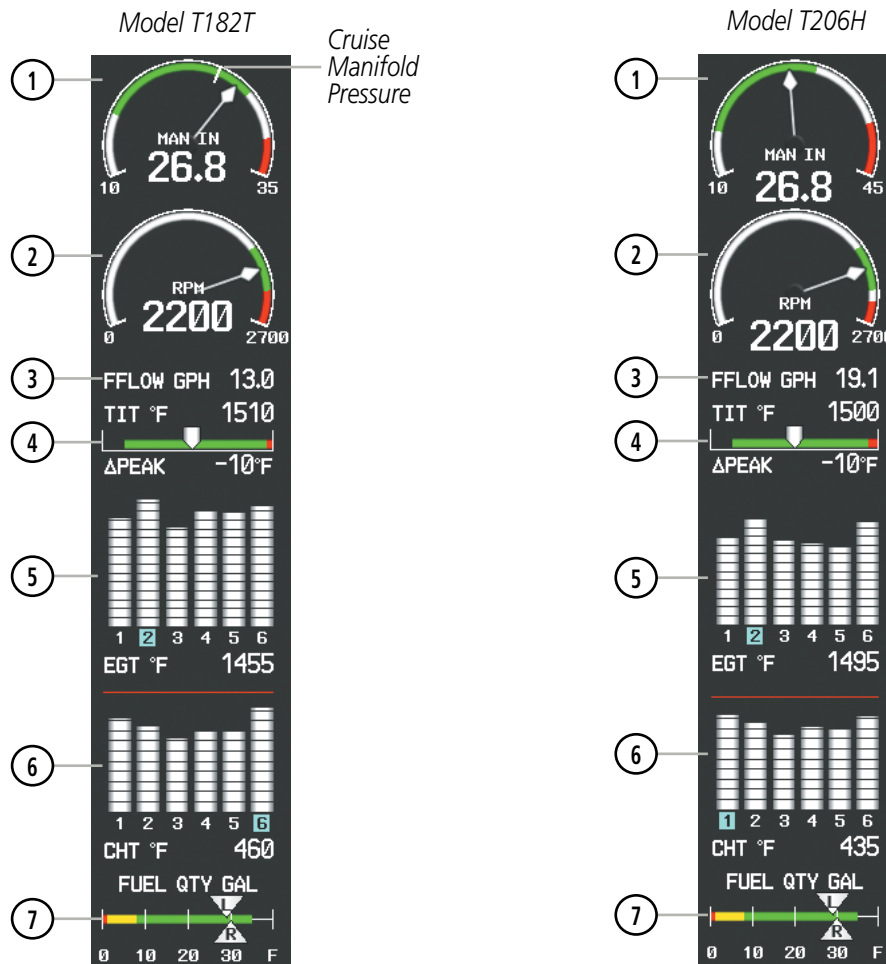

Figure 3-8 Lean Display (Turbocharged Aircraft)

3.3 SYSTEM DISPLAY

NORMALLY-ASPIRATED AND TURBOCHARGED AIRCRAFT



NOTE: Fuel calculations do not use the aircraft fuel quantity indicators and are calculated from the last time the fuel was reset.



NOTE: Refer to the Pilot's Operating Handbook (POH) for fuel values and limitations. The displayed fuel remaining can be adjusted up to 53 gal (Models 172R, 172S) or 87 gal (Models 182T, T182T, 206H, T206H).

The System Display is accessed by pressing the **ENGINE** Softkey followed by the **SYSTEM** Softkey and shows critical engine, fuel, and electrical parameters. The engine gauge(s) and Fuel Quantity Indicator remain on the System Display. Numeric readouts for oil pressure and temperature are displayed, and for Models 182T, T182T, 206H, and T206H, a readout for engine hours and the Vacuum Pressure Indicator are also shown. Electrical indicators are at the bottom of the display.

Fuel calculations are also shown on this display. Fuel calculations are based on the fuel flow totalizer and the displayed fuel remaining, adjusted by the pilot using the following softkeys:

- **RST FUEL** – Resets totalizer-based fuel remaining (GAL REM) and the fuel used (GAL USED) to zero
- **GAL REM** – Gives access to softkeys for adjusting the amount of fuel remaining for purposes of fuel calculations

Fuel remaining can be adjusted using the appropriate softkeys in one or ten-gallon increments, up to either the maximum amount allowed for the aircraft or to the tab amount: 35 gallons (Models 172R and 172S) or 64 gallons (Models 182T, T182T, 206H, and T206H).

- ① **Engine Manifold Pressure Gauge (MAN IN)**
Models 182T, T182T, 206H, T206H Displays engine power in inches of mercury (in Hg)
Turbocharged aircraft – Red range indicates maximum manifold pressure
Model T182T – A white tick mark indicates the cruise manifold pressure
- ② **Tachometer (RPM)**
Models 172S, 206H, and T206H Displays propeller speeds in revolutions per minute (rpm)
 Red range indicates propeller overspeed warning
Models 172S, 206H, and T206H – White high-rpm range indicates above normal operating speeds
Model 172S – When ascending through 5300 ft, the upper end of the green arc displays 2600 rpm and ascending through 10,300 displays 2700 rpm. When descending below 9700 ft, the upper end of the green arc returns to 2600 rpm and descending below 4700 ft returns to 2500 rpm (Figure 3-6)
- ③ **Oil Pressure (OIL PSI)**
 Displays pressure of the oil supplied to the engine in pounds per square inch (psi)
- ④ **Oil Temperature (OIL °F)**
 Displays the engine oil temperature in degrees Fahrenheit (°F)
- ⑤ **Engine Hours (Tach) (ENG HRS)**
Models 182T, T182T, 206H, T206H Displays a numeric readout for the time in hours (hrs) the engine has been in service
- ⑥ **Vacuum Pressure Indicator (VAC)**
Models 182T, T182T, 206H, T206H Displays vacuum pump pressure for the standby instruments
- ⑦ **Fuel Flow (FFLOW GPH)**
 Displays the current fuel flow in gallons per hour (gph)
- ⑧ **Calculated Fuel Used (GAL USED)**
 Displays quantity of fuel used in gallons (gal) based on fuel flow since last reset
- ⑨ **Set Fuel Remaining (GAL REM)**
 Displays current fuel remaining in gal as set by the pilot and adjusted for fuel burn since last set
- ⑩ **Fuel Quantity Indicator (FUEL QTY GAL)**
 Displays the quantity of fuel in gal in each tank (left–L and right–R) from zero to full (F)
 When full, the indicator displays to 35 gal per side (24 gal for *Models 172R and 172S*).
- ⑪ **Voltmeter (M, E BUS VOLTS)**
 Displays the main and essential bus voltages
- ⑫ **Ammeter (M, S BATT AMPS)**
 Displays the main and standby battery load in amperes

- SYSTEM OVERVIEW
- FLIGHT INSTRUMENTS
- EIS
- AUDIO PANEL & CNS
- FLIGHT MANAGEMENT
- HAZARD AVOIDANCE
- AFCS
- ADDITIONAL FEATURES
- APPENDICES
- INDEX

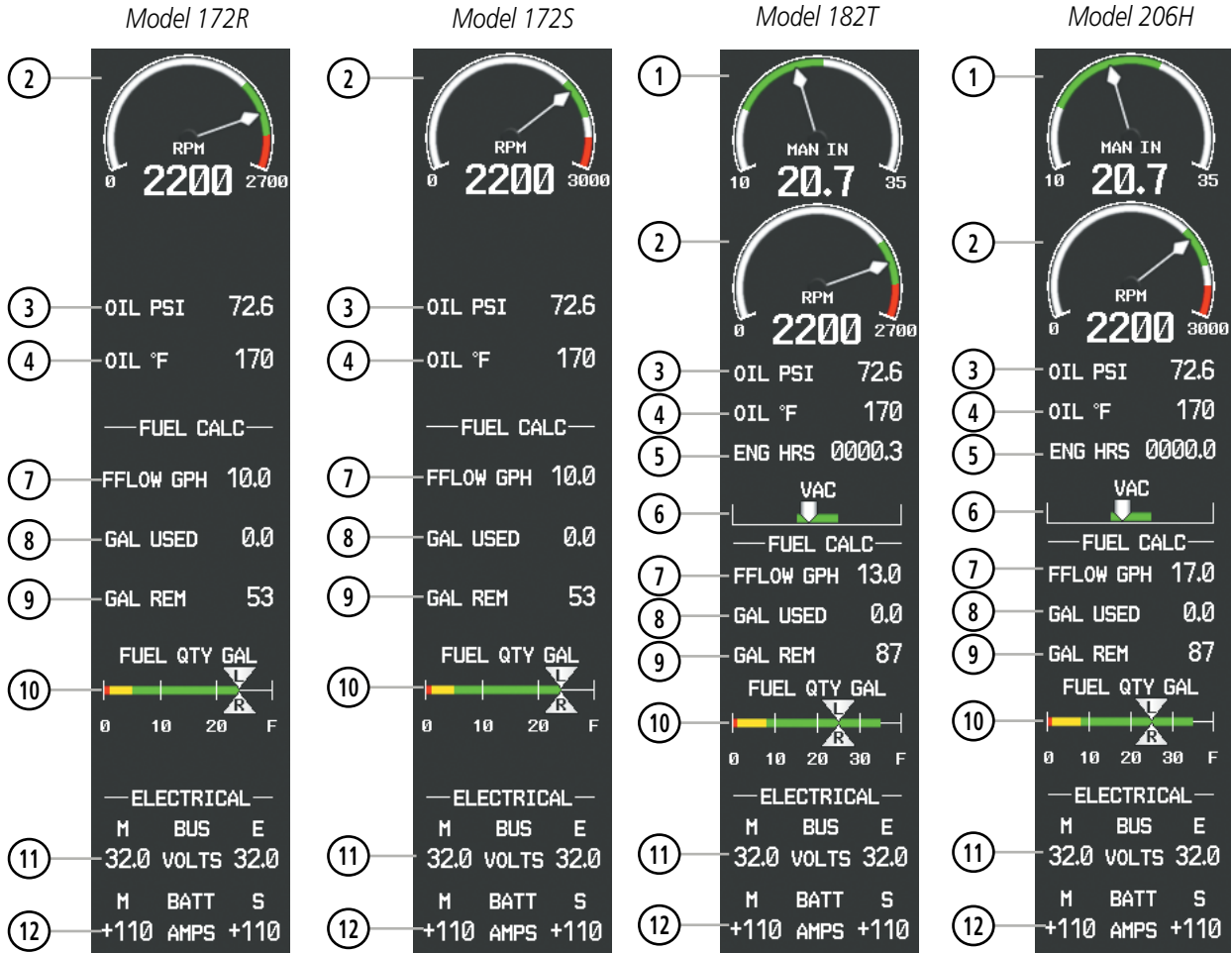

Figure 3-9 System Display (Normally-Aspirated Aircraft)

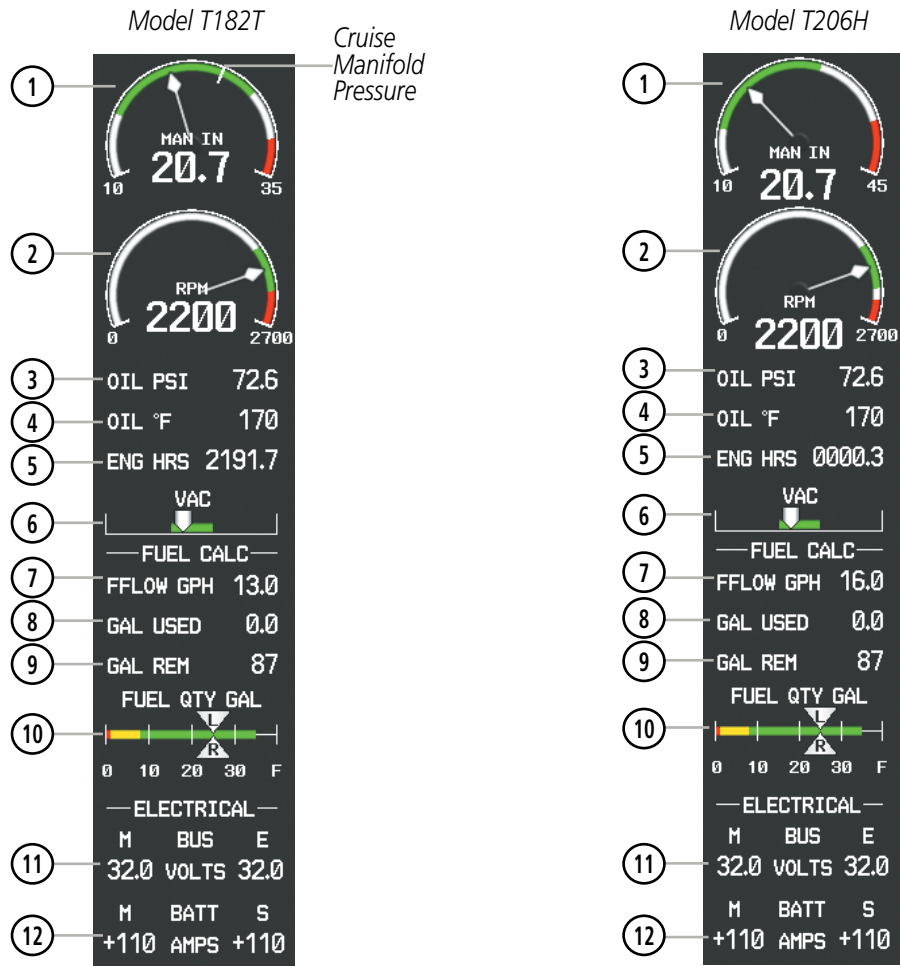

Figure 3-10 System Display (Turbocharged Aircraft)

SYSTEM
OVERVIEW

FLIGHT
INSTRUMENTS

EIS

AUDIO PANEL
& CNS

FLIGHT
MANAGEMENT

HAZARD
AVOIDANCE

AFCS

ADDITIONAL
FEATURES

APPENDICES

INDEX

BLANK PAGE

SECTION 4 AUDIO PANEL AND CNS

4.1 OVERVIEW

The Communication/Navigation/Surveillance (CNS) system includes the Audio Panel, communication radios, navigation radios, and Mode S transponder. The System Overview Section provides a block diagram description of the Audio Panel and CNS system interconnection.

CNS operation in Cessna Nav III aircraft is performed by the following Line Replaceable Units (LRUs):

- Primary Flight Display (PFD)
- Multi Function Display (MFD)
- Integrated Avionics Unit (2)
- Audio Panel
- Mode S Transponder

The MFD/PFD controls are used to tune the communication transceivers and navigation radios.

The Audio Panel provides the traditional audio selector functions of microphone and receiver audio selection. The Audio Panel includes an intercom system (ICS) between the pilot, copilot, and passengers, a marker beacon receiver, and a COM clearance recorder. Ambient noise from the aircraft radios is reduced by a feature called Master Avionics Squelch (MASQ). When no audio is detected, MASQ processing further reduces the amount of background noise from the radios.

The Mode S transponder is controlled with softkeys and the **FMS** Knob located on the Primary Flight Display (PFD). The Transponder Data Box is located to the left of the System Time Box. The data box displays the active four-digit code, mode, and reply status (Figure 4-1).

MFD/PFD CONTROLS AND FREQUENCY DISPLAY



Figure 4-1 MFD/PFD Controls, COM/NAV Frequency Tuning Boxes, and DME Tuning Window (Cessna 172R PFD Shown)

- ① **NAV VOL/ID Knob** – Controls NAV audio volume level. Press to turn the Morse code identifier audio on and off. Volume level is shown in the NAV frequency field as a percentage.
- ② **NAV Frequency Transfer Key** – Transfers the standby and active NAV frequencies.
- ③ **NAV Knob** – Tunes the standby frequencies for the NAV receiver (large knob for MHz; small knob for kHz). Press to move the tuning box (light blue box) and Frequency Transfer Arrow between NAV1 and NAV2.
- ④ **NAV Frequency Box** – Displays NAV standby and active frequency fields, volume, and station ID. The frequency of the NAV radio selected for navigation is displayed in green.
- ⑤ **COM Frequency Box** – Displays COM standby and active frequency fields and volume. The selected COM transceiver frequency is displayed in green.
- ⑥ **COM Knob** – Tunes the standby frequencies for the COM transceiver (large knob for MHz; small knob for kHz). Press to move the tuning box (light blue box) and Frequency Transfer Arrow between COM1 and COM2.
- ⑦ **COM Frequency Transfer Key** – Transfers the standby and active COM frequencies. Press and hold this key for two seconds to tune the emergency frequency (121.500 MHz) automatically into the active frequency field.
- ⑧ **COM VOL/SQ Knob** – Controls COM audio volume level. Press to turn the COM automatic squelch on and off. Volume level is shown in the COM frequency field as a percentage.
- ⑨ **DME Tuning Window** – Displays DME frequency pairing mode. Display by pressing the **DME** Softkey.
- ⑩ **ENT Key** – Validates or confirms DME pairing mode and Auto-tune selection.
- ⑪ **FMS Knob** – Flight Management System Knob, used to enter transponder codes, select DME modes, and Auto-tune entries when DME Tuning Window or NRST Window is present. Press the **FMS** Knob to turn the selection cursor on and off. The large knob moves the cursor in the window. The small knob selects individual characters for the highlighted cursor location.
- ⑫ **Transponder Data Box** – Indicates the selected transponder code, operating mode, reply, and ident status for the transponder.

AUDIO PANEL CONTROLS

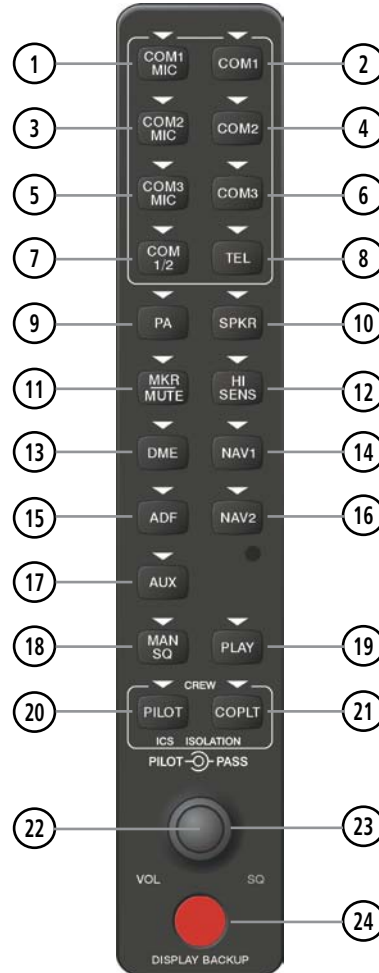

Figure 4-2 Audio Panel Controls



NOTE: When a key is selected, a triangular annunciator above the key is illuminated.

- ① **COM1 MIC** – Selects the #1 transmitter for transmitting. COM1 receive is simultaneously selected when this key is pressed allowing received audio from the #1 COM receiver to be heard. COM2 receive can be added by pressing the **COM2** Key.
- ② **COM1** – When selected, audio from the #1 COM receiver can be heard.
- ③ **COM2 MIC** – Selects the #2 transmitter for transmitting. COM2 receive is simultaneously selected when this key is pressed allowing received audio from the #2 COM receiver to be heard. COM1 receive can be added by pressing the **COM1** Key.
- ④ **COM2** – When selected, audio from the #2 COM receiver can be heard.
- ⑤ **COM3 MIC** – Not used in Cessna Nav III aircraft.

- ⑥ **COM3** – Not used in Cessna Nav III aircraft.
- ⑦ **COM 1/2** – Not used in Cessna Nav III aircraft.
- ⑧ **TEL** – Not used in Cessna Nav III aircraft.
- ⑨ **PA** – Selects the passenger address system. The selected COM transmitter is deselected when the **PA** Key is pressed. [(T)182T and (T)206H only, not used in Cessna 172R/S or 172TD aircraft.]
- ⑩ **SPKR** – Selects and deselects the cabin speaker. COM and NAV receiver audio can be heard on the speaker.
- ⑪ **MKR/MUTE** – Selects marker beacon receiver audio. Mutes the currently received marker beacon receiver audio. Unmutes automatically when new marker beacon audio is received. Also, stops play of recorded COM audio.
- ⑫ **HI SENS** – Press to increase marker beacon receiver sensitivity. Press again to return to low sensitivity.
- ⑬ **DME** – Turns optional DME audio on or off.
- ⑭ **NAV1** – When selected, audio from the #1 NAV receiver can be heard.
- ⑮ **ADF** – Turns optional ADF receiver audio on or off.
- ⑯ **NAV2** – When selected, audio from the #2 NAV receiver can be heard.
- ⑰ **AUX** – Not used in Cessna Nav III aircraft.
- ⑱ **MAN SQ** – Enables manual squelch for the intercom. When the intercom is active, press the **PILOT** Knob to illuminate SQ. Turn the **PILOT/PASS** Knobs to adjust squelch.
- ⑲ **PLAY** – Press once to play the last recorded COM audio. Press again while audio is playing and the previous block of recorded audio is played. Each subsequent press plays each previously recorded block. Pressing the **MKR/MUTE** Key during play of a memory block stops play.
- ⑳ **PILOT** – Selects and deselects the pilot intercom isolation.
- ㉑ **COPLT** – Selects and deselects the copilot intercom isolation.
- ㉒ **PILOT Knob** – Press to switch between volume and squelch control as indicated by illumination of VOL or SQ. Turn to adjust intercom volume or squelch. The **MAN SQ** Key must be selected to allow squelch adjustment.
- ㉓ **PASS Knob** – Turn to adjust Copilot/Passenger intercom volume or squelch. The **MAN SQ** Key must be selected to allow squelch adjustment.
- ㉔ **DISPLAY BACKUP Button** – Manually selects Reversionary Mode.

4.2 COM OPERATION

COM TRANSCIVER SELECTION AND ACTIVATION

- NOTE:** During PA Mode, the COM MIC Annunciator is extinguished and the COM active frequency color changes to white, indicating that neither COM transmitter is active.
- NOTE:** When turning on the G1000 for use, the system remembers the last frequencies used and the active COM transceiver state prior to shutdown.

The COM Frequency Box is composed of four fields; the two active frequencies are on the left side and the two standby frequencies are on the right. The COM transceiver is selected for transmitting by pressing the **COM MIC** Keys on the Audio Panel. During reception of audio from the COM radio selected for transmission, audio from the other COM radio is muted.

An active COM frequency displayed in green indicates that the COM transceiver is selected on the Audio Panel (**COM1 MIC** or **COM2 MIC** Key). Both active COM frequencies appearing in white indicate that no COM radio is selected for transmitting [**PA** Key is selected on the Audio Panel, (T)182T and (T)206H only].

Frequencies in the standby fields are displayed in white.

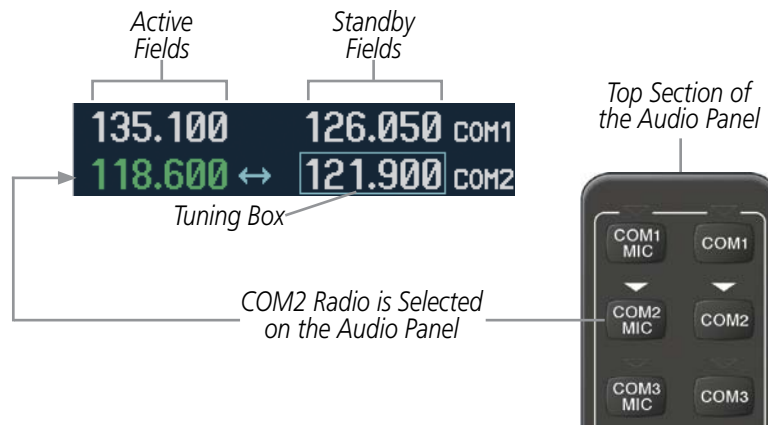

Figure 4-3 Selecting a COM Radio for Transmit

TRANSMIT/RECEIVE INDICATIONS

During COM transmission, a white TX appears by the active COM frequency replacing the Frequency Transfer Arrow. On the Audio Panel, when the active COM is transmitting, the active transceiver **COM MIC** Key Annunciator flashes approximately once per second.

During COM signal reception, a white RX appears by the active COM frequency replacing the Frequency Transfer Arrow. Entertainment audio, if selected, is muted during active COM radio reception. Refer to Additional Audio Panel Functions later in this section, and details on the Data Link Receiver in the Additional Features Section.



Figure 4-4 COM Radio Transmit and Receive Indications

COM TRANSCEIVER MANUAL TUNING

The COM frequency controls and frequency boxes are on the right side of the MFD and PFD.

Manually tuning a COM frequency:

- 1) Turn the **COM** Knob to tune the desired frequency in the COM Tuning Box (large knob for MHz; small knob for kHz).
- 2) Press the **Frequency Transfer** Key to transfer the frequency to the active field.
- 3) Adjust the volume level with the COM **VOL/SQ** Knob.
- 4) Press the COM **VOL/SQ** Knob to turn automatic squelch on and off.



Figure 4-5 COM Frequency Tuning

SELECTING THE RADIO TO BE TUNED

Press the small **COM** Knob to transfer the frequency tuning box and Frequency Transfer Arrow between the upper and lower radio frequency fields.

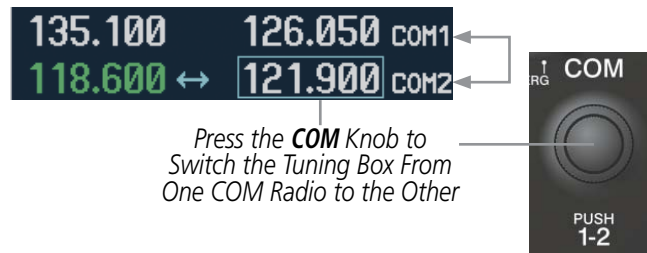

Figure 4-6 Switching COM Tuning Boxes

QUICK-TUNING AND ACTIVATING 121.500 MHZ

Pressing and holding the COM **Frequency Transfer** Key for two seconds automatically loads the emergency COM frequency (121.500 MHz) in the active field of the COM radio selected for tuning (the one with the transfer arrow). In the example shown, pressing the Audio Panel **COM2 MIC** Key activates the transceiver.

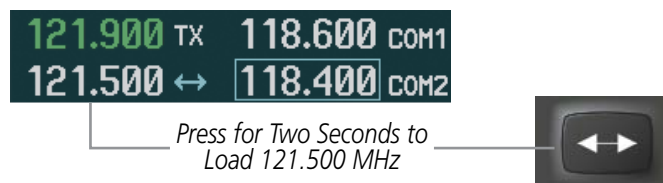

Figure 4-7 Quickly Tuning 121.500 MHz

- SYSTEM OVERVIEW
- FLIGHT INSTRUMENTS
- EIS
- AUDIO PANEL & CNS
- FLIGHT MANAGEMENT
- HAZARD AVOIDANCE
- AFCS
- ADDITIONAL FEATURES
- APPENDICES
- INDEX

AUTO-TUNING THE COM FREQUENCY

COM frequencies can be automatically tuned from the following:

- Nearest Airports Window (PFD)
- WPT – Airport Information Page
- NRST – Nearest Airports Page
- NRST – Nearest Frequencies Page (ARTCC, FSS, WX)
- NRST – Nearest Airspaces Page

AUTO-TUNING FROM THE PFD

COM frequencies for the nearest airports can be automatically tuned from the Nearest Airports Window on the PFD. When the desired frequency is entered, it becomes a standby frequency. Pressing the **Frequency Transfer** Key places this frequency into the COM Active Frequency Field.

Auto-tuning a COM frequency for a nearby airport from the PFD:

- 1) Press the **NRST** Softkey on the PFD to open the Nearest Airports Window. A list of 25 nearest airport identifiers and COM frequencies is displayed.
- 2) Turn the **FMS** Knob to scroll through the list and highlight the desired COM frequency.
- 3) Press the **ENT** Key to load the COM frequency into the COM Standby Tuning Box.
- 4) Press the **Frequency Transfer** Key to transfer the frequency to the COM Active Frequency Field.



Press the **NRST** Softkey to Open the Nearest Airports Window

Figure 4-8 Nearest Airports Window (PFD)

AUTO-TUNING FROM THE MFD

Frequencies can be automatically loaded into the COM Frequency Box from pages in the NRST or WPT page group by highlighting the frequency and pressing the **ENT** Key (Figures 4-9, 4-10, and 4-11).

Auto-tuning a COM frequency from the WPT and NRST Pages:

- 1) From any page that the COM frequency can be auto-tuned, activate the cursor by pressing the **FMS** Knob or the appropriate softkey.
- 2) Turn the **FMS** Knob to place the cursor on the desired COM frequency (Figure 4-11).
- 3) Press the **ENT** Key to load the COM frequency into the standby field of the selected COM radio.
- 4) Press the **Frequency Transfer** Key to transfer the frequency to the COM Active Frequency Field.

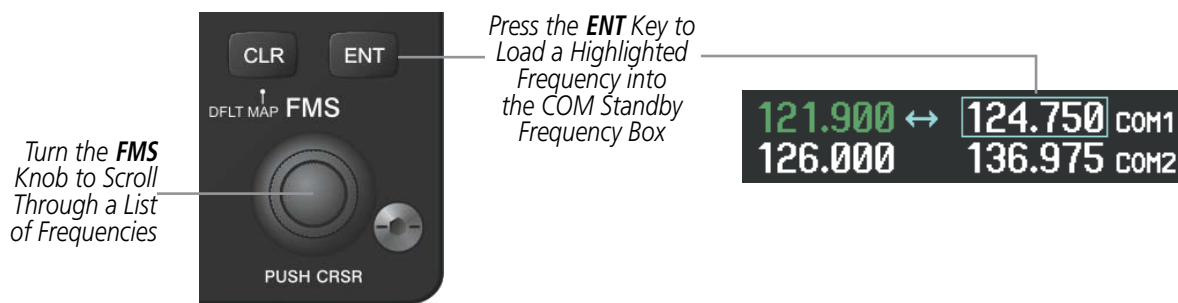

Figure 4-9 Frequency Auto-Tuning from the MFD

Or:

- 1) On the Nearest Airports, Frequencies, or Airspaces page, press the **MENU** Key to display the page menu.
- 2) Turn the large **FMS** Knob to scroll through the menu options.
- 3) Press the **ENT** Key to place the cursor on the desired selection.
- 4) Scroll through the frequency selections with the **FMS** Knob.
- 5) Press the **ENT** Key to load the COM frequency into the standby field of the selected COM radio.
- 6) Press the **Frequency Transfer** Key to transfer the frequency to the COM Active Frequency Field.

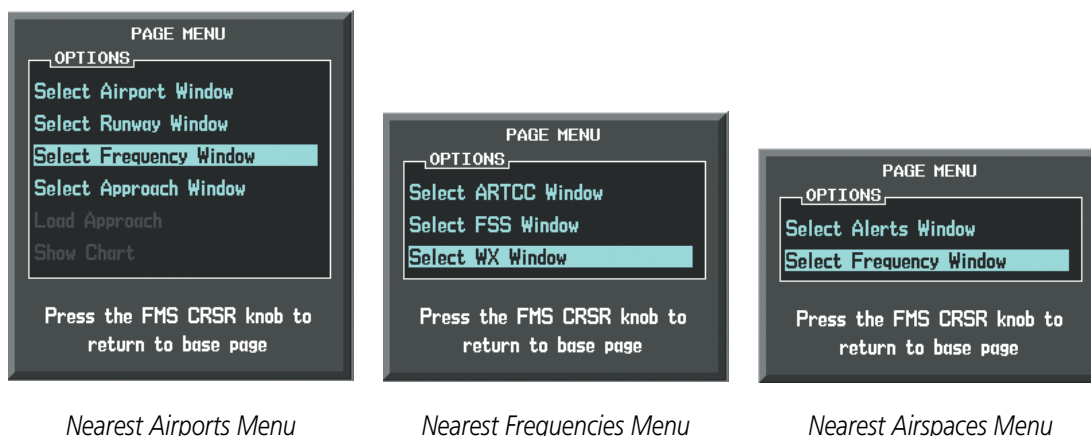

Figure 4-10 Nearest Pages Menus

On the WPT - Airport Information Page, the cursor can be placed on the frequency field by pressing the **FMS** Knob and scrolling through the list. The frequency is transferred to the COM Standby Field with the **ENT** Key.



Press **Frequency Transfer** Key to Load Frequency into COM Active Frequency Field

Selected Airport Identifier and Information

Runway Information

Press **ENT** Key to Load Frequency into COM Standby Field. Cursor then advances to next frequency.

Press **INFO** Softkey for AIRPORT, RUNWAYS, and FREQUENCIES Windows

Figure 4-11 WPT – Airport Information Page

COM frequencies can also be auto-tuned from the NRST – Nearest Airspaces, NRST – Nearest Frequencies, and NRST – Nearest Airports Pages on the MFD in a similar manner using the appropriate softkeys or **MENU** Key, the **FMS** Knob, and the **ENT** Key.



Figure 4-12 NRST – Nearest Frequencies, NRST – Nearest Airports, and NRST – Nearest Airspaces Pages

FREQUENCY SPACING

The G1000 COM radios can tune either 25-kHz spacing (118.000 to 136.975 MHz) or 8.33-kHz spacing (118.000 to 136.990 MHz) for 760-channel or 3040-channel configuration. When 8.33-kHz channel spacing is selected, all of the 25-kHz channel spacing frequencies are also available in the complete 3040-channel list.

COM channel spacing is set on the System Setup Page of the AUX Page Group.

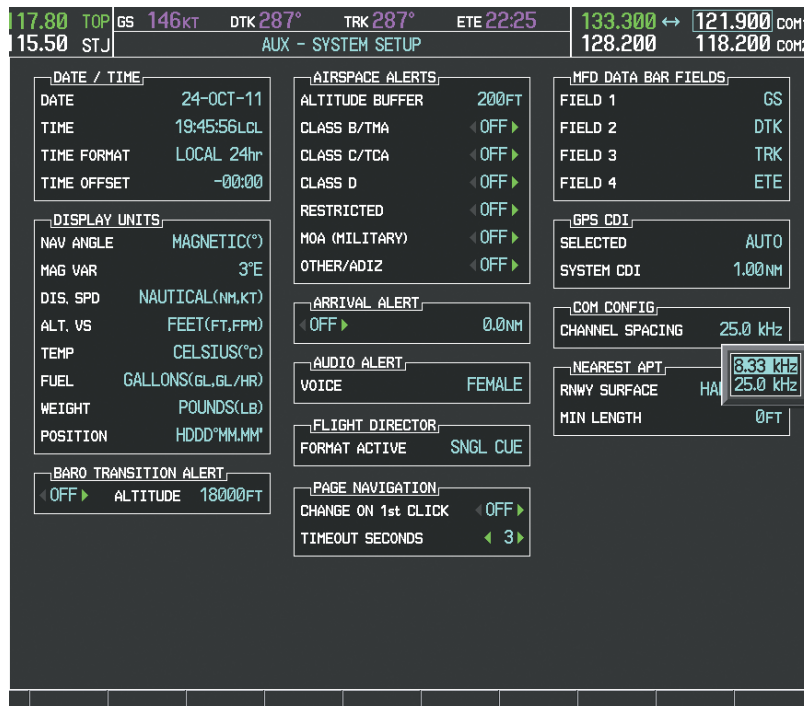

Figure 4-13 COM Channel Spacing

Changing COM frequency channel spacing:

- 1) Select the AUX – System Setup Page.
- 2) Press the **FMS** Knob to activate the flashing cursor.
- 3) Turn the large **FMS** Knob to highlight the Channel Spacing Field in the COM Configuration Box.
- 4) Turn the small **FMS** Knob to select the desired channel spacing.
- 5) Press the **ENT** Key to complete the channel spacing selection.

While the COM CONFIG Window is selected, the G1000 softkeys are blank.



Select 8.33-kHz or 25.0-kHz COM Frequency Channel Spacing

Figure 4-14 AUX – System Setup Page

AUTOMATIC SQUELCH

Automatic Squelch quiets unwanted static noise when no audio signal is received, while still providing good sensitivity to weak COM signals. To disable Automatic Squelch, press the **VOL/SQ** Knob. When Automatic Squelch is disabled, COM audio reception is always on. Continuous static noise is heard over the headsets and speaker, if selected. Pressing the **VOL/SQ** Knob again enables Automatic Squelch.

When Automatic Squelch is disabled, a white SQ appears next to the COM frequency.



Figure 4-15 Overriding Automatic Squelch

VOLUME

COM radio volume level can be adjusted from 0 to 100% using the **VOL/SQ** Knob. Turning the knob clockwise increases volume, turning the knob counterclockwise decreases volume. When adjusting volume, the level is displayed in place of the standby frequencies. Volume level indication remains for two seconds after the change.



Figure 4-16 COM Volume Level

4.3 NAV OPERATION

NAV RADIO SELECTION AND ACTIVATION

The NAV Frequency Box is composed of four fields; two standby fields and two active fields. The active frequencies are on the right side and the standby frequencies are on the left.

A NAV radio is selected for navigation by pressing the **CDI** Softkey located on the PFD. The active NAV frequency selected for navigation is displayed in green. Pressing the **CDI** Softkey once selects NAV1 as the navigation radio. Pressing the **CDI** Softkey a second time selects NAV2 as the navigation radio. Pressing the **CDI** Softkey a third time activates GPS mode. Pressing the **CDI** Softkey again cycles back to NAV1.

While cycling through the **CDI** Softkey selections, the NAV Tuning Box and the Frequency Transfer Arrow are placed in the active NAV Frequency Field and the active NAV frequency color changes to green.

The three navigation modes that can be cycled through are:

- VOR1 (or LOC1) – If NAV1 is selected, a green single line arrow (not shown) labeled either VOR1 or LOC1 is displayed on the HSI and the active NAV1 frequency is displayed in green.
- VOR2 (or LOC2) – If NAV2 is selected, a green double line arrow (shown) labeled either VOR2 or LOC2 is displayed on the HSI and the active NAV2 frequency is displayed in green.
- GPS – If GPS Mode is selected, a magenta single line arrow (not shown) appears on the HSI and neither NAV radio is selected. Both active NAV frequencies are then displayed in white.

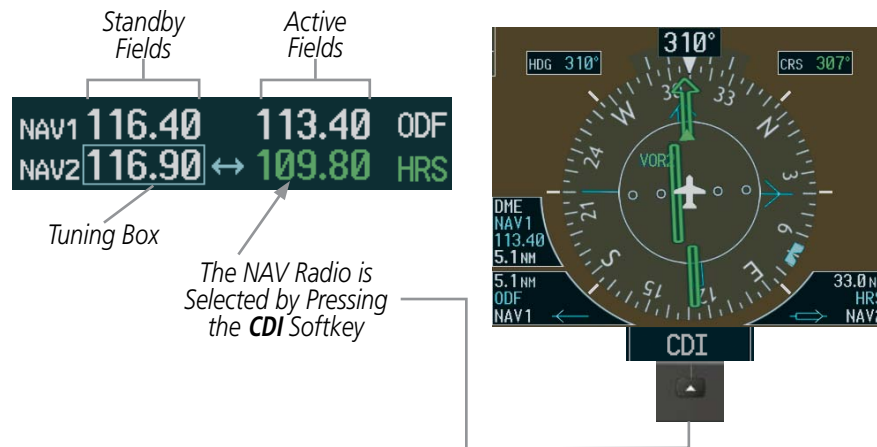

Figure 4-17 Selecting a NAV Radio for Navigation

See the Flight Instruments Section for selecting the DME and Bearing Information windows and using VOR or ADF as the source for the bearing pointer.

NAV radios are selected for listening by pressing the corresponding keys on the Audio Panel. Pressing the **NAV1**, **NAV2**, **ADF**, or **DME** Key selects and deselects the navigation radio source. Selected audio can be heard over the headset and the speaker (if selected). All radios can be selected individually or simultaneously.



Figure 4-18 Selecting a NAV Radio Receiver

NAV RECEIVER MANUAL TUNING

The NAV frequency controls and frequency boxes are on the left side of the MFD and PFD.

Manually tuning a NAV frequency:

- 1) Turn the **NAV** Knob to tune the desired frequency in the NAV Tuning Box.
- 2) Press the **Frequency Transfer** Key to transfer the frequency to the NAV Active Frequency Field.
- 3) Adjust the volume level with the NAV **VOL/ID** Knob.
- 4) Press the NAV **VOL/ID** Knob to turn the Morse code identifier audio on and off.

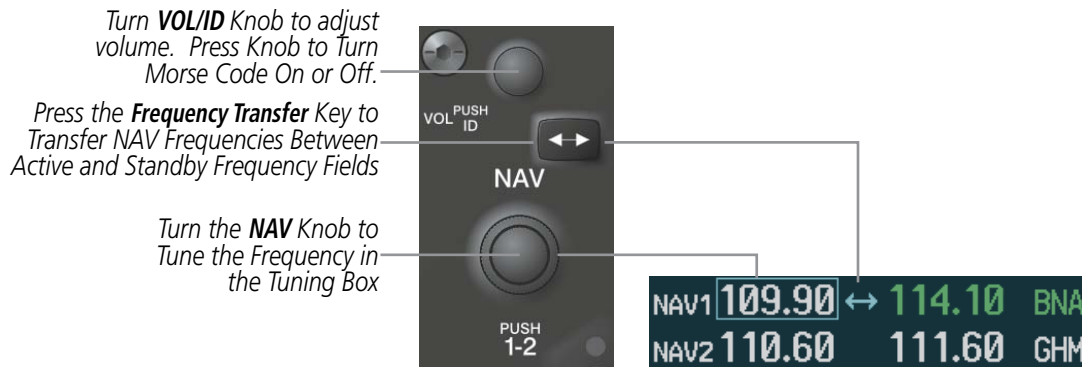

Figure 4-19 NAV Frequency Tuning

SELECTING THE RADIO TO BE TUNED

Press the small **NAV** Knob to transfer the frequency tuning box and Frequency Transfer Arrow between the upper and lower radio frequency fields.

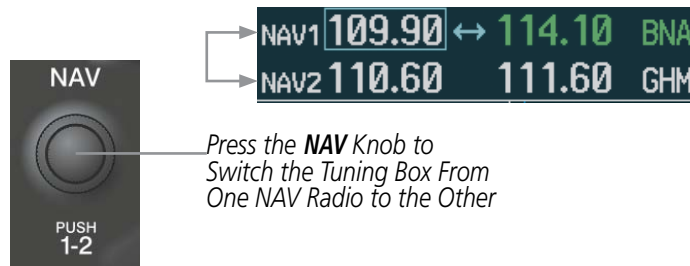

Figure 4-20 Switching NAV Tuning Boxes

VOR/LOC ID

When the Morse code Identifier audio is on for a NAV radio, a white ID appears to the left of the active NAV frequency.

In the example shown, in order to listen to either station identifier, press the **NAV1** or **NAV2** Key on the Audio Panel. Pressing the **VOL/ID** Knob turns off the Morse code audio only in the radio with the NAV Tuning Box. To turn off both NAV IDs, transfer the NAV Tuning Box between NAV1 and NAV2 by pressing the small **NAV** Knob and press the **VOL/ID** Knob again to turn the Morse code off in the other radio.



Figure 4-21 NAV Radio ID Indication

VOLUME

NAV Radio volume level can be adjusted from 0 to 100% using the **VOL/ID** Knob. Turning the knob clockwise increases volume, counterclockwise decreases volume.

When adjusting, the level is displayed in place of the standby frequencies. Volume level indication remains for two seconds after the change.

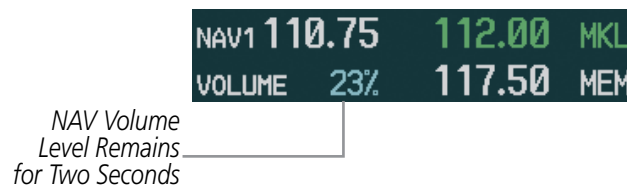

Figure 4-22 NAV Volume Levels

AUTO-TUNING A NAV FREQUENCY FROM THE MFD

NAV frequencies can be selected and loaded from the following MFD pages:

- WPT – Airport Information
- WPT – VOR Information
- NRST – Nearest Airports
- NRST – Nearest VOR
- NRST – Nearest Frequencies (FSS, WX)
- NRST – Nearest Airspaces

The MFD provides auto-tuning of NAV frequencies from waypoint and nearest pages. During enroute navigation, the NAV frequency is entered automatically into the NAV standby frequency field. During approach activation the NAV frequency is entered automatically into the NAV active frequency field.

Frequencies can be automatically loaded into the NAV Frequency Box from pages in the NRST or WPT page group by highlighting the frequency and pressing the **ENT** Key (Figures 4-23, 4-24, and 4-25).

Auto-tuning a NAV frequency from the WPT and NRST Pages:

- 1) From any page that the NAV frequency can be auto-tuned, activate the cursor by pressing the **FMS** Knob or the appropriate softkey.
- 2) Turn the **FMS** Knob to place the cursor on the desired NAV identifier or NAV frequency.
- 3) On the Nearest VOR, Nearest Airspaces, and Nearest Airports pages, press the **FREQ** Softkey to place the cursor on the NAV frequency (Figure 4-25).
- 4) Press the **ENT** Key to load the NAV frequency into the standby field of the selected NAV radio.
- 5) Press the **Frequency Transfer** Key to transfer the frequency to the NAV Active Frequency Field.

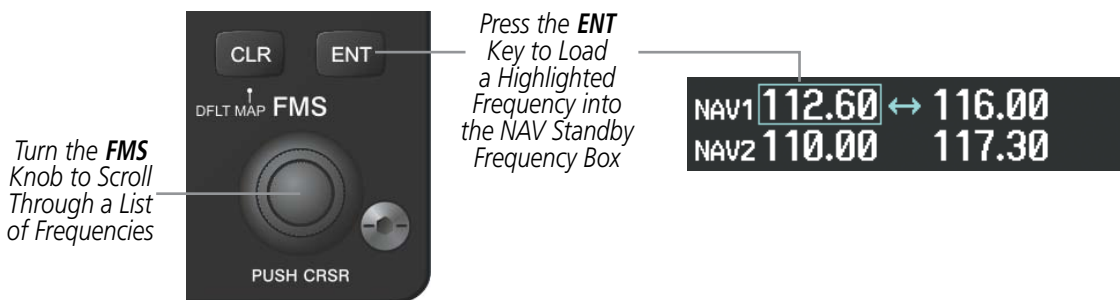

Figure 4-23 NAV Frequency Auto-Tuning from the MFD

Or:

- 1) When on the NRST pages, press the **MENU** Key to display the page menu.
- 2) Turn the large **FMS** Knob to scroll through the menu options.
- 3) Press the **ENT** Key to place the cursor in the desired window.
- 4) Scroll through the frequency selections with the **FMS** Knob.
- 5) Press the **ENT** Key to load the NAV frequency into the standby field of the selected NAV radio.
- 6) Press the **Frequency Transfer** Key to transfer the frequency to the NAV Active Frequency Field.

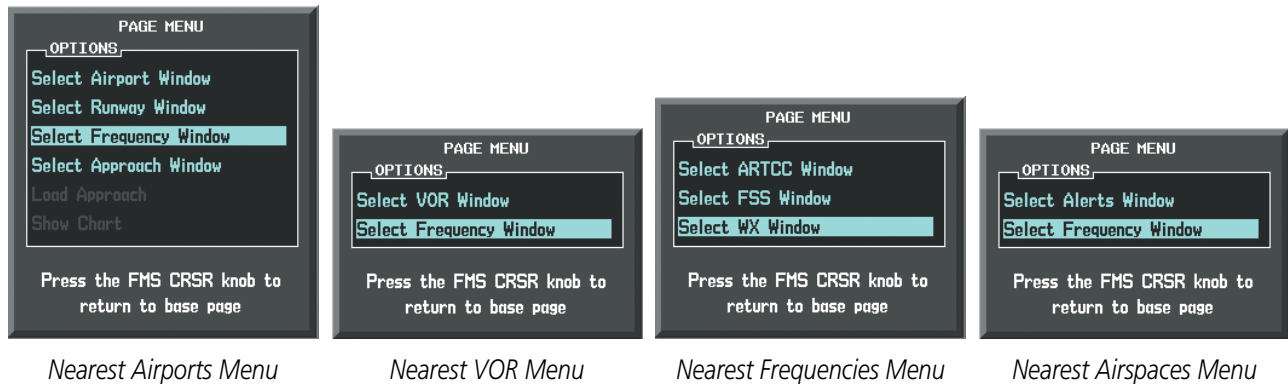

Figure 4-24 Nearest Pages Menus

SYSTEM OVERVIEW

FLIGHT INSTRUMENTS

EIS

AUDIO PANEL & CNS

FLIGHT MANAGEMENT

HAZARD AVOIDANCE

AFCS

ADDITIONAL FEATURES

APPENDICES

INDEX

In the example shown, the VOR list is selected with the **VOR** Softkey or from the page menu. The **FMS** Knob or **ENT** Key is used to scroll through the list. The cursor is placed on the frequency with the **FREQ** Softkey and loaded into the NAV Tuning Box with the **ENT** Key.



Press the **VOR** Softkey to Place the Cursor on the VOR Identifier

Press the **FREQ** Softkey to Place the Cursor on the VOR Frequency

Press the **ENT** Key to Load the Frequency into the NAV Standby Field.

Figure 4-25 Loading the NAV Frequency from the NRST – Nearest VOR Page

While enroute, NAV frequencies can also be auto-tuned from the NRST – Nearest Airports, WPT – Airport Information, WPT – VOR Information, and NRST – Nearest Frequencies Pages on the MFD in a similar manner using the appropriate softkeys or **MENU** Key, the **FMS** Knob, and the **ENT** Key.



Figure 4-26 NRST – Nearest Frequencies, WPT – VOR Information, WPT – Airport Information, and NRST – Nearest Airports Pages

SYSTEM OVERVIEW

FLIGHT INSTRUMENTS

EIS

AUDIO PANEL & CNS

FLIGHT MANAGEMENT

HAZARD AVOIDANCE

AFCS

ADDITIONAL FEATURES

APPENDICES

INDEX

AUTO-TUNING NAV FREQUENCIES ON APPROACH ACTIVATION



NOTE: The primary NAV frequency is auto-tuned upon loading a VOR or ILS/Localizer approach.



NOTE: When an ILS/LOC approach has been activated while navigating by GPS, the system automatically switches to LOC as the final approach course is intercepted (within 15 nm of the FAF). See the Flight Management Section for details.

NAV frequencies are automatically loaded into the NAV Frequency Box on approach activation.

When loading or activating a VOR or ILS/LOC approach, the approach frequency is automatically transferred to a NAV frequency field as follows:

- If the current CDI navigation source is GPS, the approach frequency is transferred to the NAV1 active frequency field. The frequency that was previously in the NAV1 active frequency field is transferred to standby.
- If the current CDI navigation source is GPS, and if the approach frequency is already loaded into the NAV1 standby frequency field, the standby frequency is transferred to active.
- If the current CDI navigation source is NAV1 or NAV2, the approach frequency is transferred to the standby frequency fields of the selected CDI NAV radio.

MARKER BEACON RECEIVER

NOTE: The marker beacon indicators operate independently of marker beacon audio and cannot be turned off.

The marker beacon receiver is used as part of the ILS. The marker beacon receiver is always on and detects any marker beacon signals within the reception range of the aircraft.

The receiver detects the three marker tones – outer, middle, and inner – and provides the marker beacon annunciations located to the left of the Altimeter on the PFD.

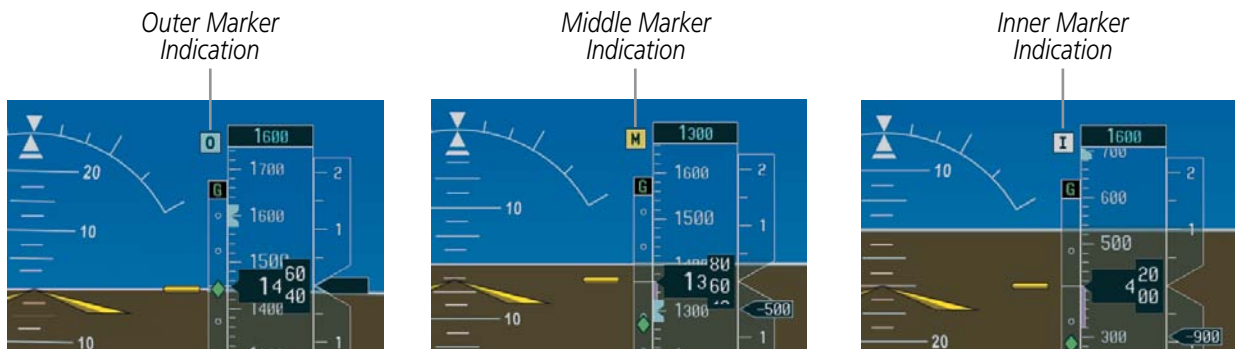

Figure 4-27 Marker Beacon Annunciations on the PFD



Figure 4-28 Marker Beacon Keys

The Audio Panel provides three different states of marker beacon operation; On, Muted, and Deselected. Pressing the **MKR/MUTE** Key selects and deselected marker beacon audio. The key annunciator indicates when marker beacon audio is selected.

During marker beacon audio reception, pressing the **MKR/MUTE** Key mutes the audio but does not affect the marker annunciations (Figure 4-27). The marker tone is silenced, then waits for the next marker tone. The **MKR/MUTE** Key Annunciator is illuminated, indicating audio muting. The audio returns when the next marker beacon signal is received. If the **MKR/MUTE** Key is pressed during signal reception (O, M, I indication) while marker beacon audio is muted, the audio is deselected and the **MKR/MUTE** Key Annunciator is extinguished.

Pressing the **HI SENS** Key switches between high and low marker beacon receiver sensitivity. The HI SENS function (annunciator illuminated) is used to provide an earlier indication when nearing a marker during an approach. The LO SENS function (annunciator extinguished) results in a narrower marker dwell while over a station.

DME TUNING

NOTE: When another auxiliary window is turned on, the DME Tuning Window is replaced on the PFD.

NOTE: When turning on the G1000 for use, the system remembers the last frequency used for DME tuning and the NAV1, NAV2, or HOLD state prior to shutdown.

The G1000 System tunes the optional DME transceiver. The UHF DME frequency is tuned by pairing with a VHF NAV frequency. DME frequency pairing is automatic and only the VHF NAV frequency is shown.

The DME Tuning Window is located to the right of the HSI in the lower right corner of the PFD. The DME transceiver is tuned by selecting NAV1, NAV2, or HOLD in the DME Tuning Window. Pressing the **DME** Softkey switches the DME Tuning Window on and off.

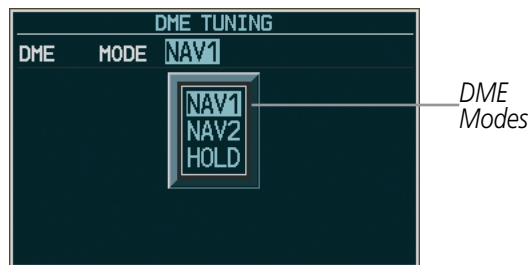

Figure 4-29 DME Tuning Window

The following DME transceiver pairings can be selected:

- NAV1 – Pairs the DME frequency from the selected NAV1 frequency.
- NAV2 – Pairs the DME frequency from the selected NAV2 frequency.
- HOLD – When in the HOLD position, the DME frequency remains paired with the last selected NAV frequency.

Selecting DME transceiver pairing:

- 1) Press the **DME** Softkey to display the DME Tuning Window.
- 2) Turn the small **FMS** Knob to select the DME tuning mode.
- 3) Press the **ENT** Key to complete the selection.

Pressing the **CLR** Key or **FMS** Knob while in the process of DME pairing cancels the tuning entry and reverts back to the previously selected DME tuning state. Pressing the **FMS** Knob activates/deactivates the cursor in the DME Tuning Window.

See the Flight Instruments Section for displaying the DME information window.

4.4 GTX 33 MODE S TRANSPONDER

The GTX 33 Mode S Transponder provides Mode A, Mode C, and Mode S interrogation and reply capabilities. Selective addressing or Mode Select (Mode S) capability includes the following features:

- Level-2 reply data link capability (used to exchange information between aircraft and ATC facilities)
- Surveillance identifier capability
- Flight ID (Flight Identification) reporting – The Mode S Transponder reports aircraft identification as either the aircraft registration or a unique Flight ID.
- Altitude reporting
- Airborne status determination
- Transponder capability reporting
- Mode S Enhanced Surveillance (EHS) requirements
- Acquisition squitter – Acquisition squitter, or short squitter, is the transponder 24-bit identification address. The transmission is sent periodically, regardless of the presence of interrogations. The purpose of acquisition squitter is to enable Mode S ground stations and aircraft equipped with a Traffic Avoidance System (TAS) to recognize the presence of Mode S-equipped aircraft for selective interrogation.

The Hazard Avoidance Section provides more details on traffic avoidance systems.

TRANSPONDER CONTROLS

Transponder function is displayed on three levels of softkeys on the PFD: Top-level, Mode Selection, and Code Selection. When the top-level **XPDR** Softkey is pressed, the Mode Selection softkeys appear: **STBY, ON, ALT, VFR, CODE, IDENT, BACK**.

When the **CODE** Softkey is pressed, the number softkeys appear: **0, 1, 2, 3, 4, 5, 6, 7, IDENT, BKSP, BACK**. The digits 8 and 9 are not used for code entry. Pressing the numbered softkeys in sequence enters the transponder code. If an error is made, the code selection cursor can be moved back to the left one digit with each press of the **BKSP** Softkey.

Pressing the **BACK** Softkey during code selection reverts to the Mode Selection Softkeys. Pressing the **BACK** Softkey during mode selection reverts to the top-level softkeys.

The code can also be entered with the **FMS** Knob on the PFD. Code entry must be completed with either the softkeys or the **FMS** Knob, but not a combination of both.

Pressing the **IDENT** Softkey while in Mode or Code Selection initiates the ident function and reverts to the top-level softkeys.

After 45 seconds of transponder softkey inactivity, the system reverts back to the top-level softkeys.

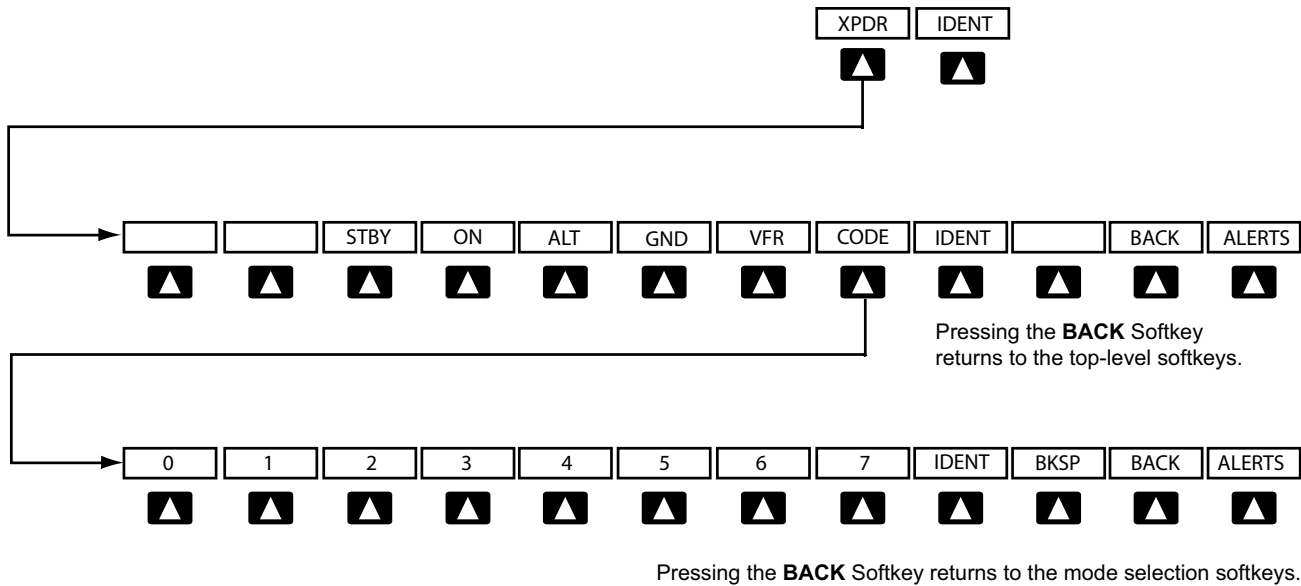

Figure 4-30 Transponder Softkeys (PFD)

TRANSPONDER MODE SELECTION

Mode selection can be automatic (Ground and Altitude Modes) or manual (Standby, ON, and Altitude Modes). The **STBY**, **ON**, and **ALT** Softkeys can be accessed by pressing the **XPDR** Softkey.

Selecting a transponder mode:

- 1) Press the **XPDR** Softkey to display the Transponder Mode Selection Softkeys.
- 2) Press the desired softkey to activate the transponder mode.

GROUND MODE

Ground Mode is normally selected automatically when the aircraft is on the ground. The transponder powers up in the last mode it was in when shut down. Ground Mode can be overridden by pressing any one of the Mode Selection Softkeys. A green **GND** indication and transponder code appear in the mode field of the Transponder Data Box. In Ground Mode, the transponder does not allow Mode A and Mode C replies, but it does permit acquisition squitter and replies to discretely addressed Mode S interrogations.

When Standby Mode has been selected on the ground, the transponder can be returned to Ground Mode by pressing the **GND** Softkey.



Figure 4-31 Ground Mode

STANDBY MODE (MANUAL)

NOTE: In Standby Mode, the IDENT function is inoperative.

Standby Mode can be selected at any time by pressing the **STBY** Softkey. In Standby, the transponder does not reply to interrogations, but new codes can be entered. When Standby is selected, a white STBY indication and transponder code appear in the mode field of the Transponder Data Box. In all other modes, these fields appear in green.



Figure 4-32 Standby Mode

MANUAL ON MODE

ON Mode can be selected at any time by pressing the **ON** Softkey. ON Mode generates Mode A and Mode S replies, but Mode C altitude reporting is inhibited. In ON Mode, a green ON indication and transponder code appear in the mode field of the Transponder Data Box.

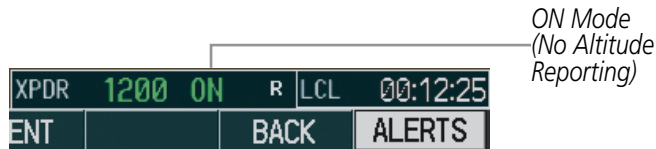

Figure 4-33 ON Mode

ALTITUDE MODE (AUTOMATIC OR MANUAL)

Altitude Mode is automatically selected when the aircraft becomes airborne. Altitude Mode may also be selected manually by pressing the **ALT** Softkey.

If Altitude Mode is selected, a green ALT indication and transponder code appear in the mode field of the Transponder Data Box, and all transponder replies requesting altitude information are provided with pressure altitude information.

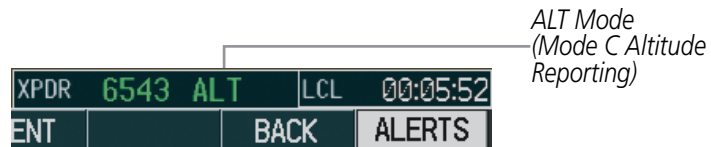

Figure 4-34 Altitude Mode

REPLY STATUS

When the transponder sends replies to interrogations, a white R indication appears momentarily in the reply status field of the Transponder Data Box.



Figure 4-35 Reply Indication

- SYSTEM OVERVIEW
- FLIGHT INSTRUMENTS
- EIS
- AUDIO PANEL & CNS
- FLIGHT MANAGEMENT
- HAZARD AVOIDANCE
- AFCS
- ADDITIONAL FEATURES
- APPENDICES
- INDEX

ENTERING A TRANSPONDER CODE

Entering a transponder code with softkeys:

- 1) Press the **XPDR** Softkey to display the Transponder Mode Selection Softkeys.
- 2) Press the **CODE** Softkey to display the Transponder Code Selection Softkeys, for digit entry.
- 3) Press the digit softkeys to enter the code in the code field. When entering the code, the next softkey in sequence must be pressed within 10 seconds, or the entry is cancelled and restored to the previous code. Pressing the **BKSP** Softkey moves the code selection cursor to the previous digit. Five seconds after the fourth digit has been entered, the transponder code becomes active.

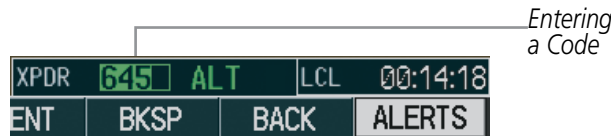

Figure 4-36 Entering a Code

Entering a transponder code with the PFD FMS Knob:

- 1) Press the **XPDR** and the **CODE** Softkeys as in the previous procedure to enable code entry.
- 2) Turn the small **FMS** Knob on the PFD to enter the first two code digits.
- 3) Turn the large **FMS** Knob to move the cursor to the next code field.
- 4) Enter the last two code digits with the small **FMS** Knob.
- 5) Press the **ENT** Key to complete code digit entry.

Pressing the **CLR** Key or small **FMS** Knob before code entry is complete cancels code entry and restores the previous code. Waiting for 10 seconds after code entry is finished activates the code automatically.



Figure 4-37 Entering a Code with the FMS Knob

VFR CODE

The VFR code can be entered either manually or by pressing the **XPDR** Softkey, then the **VFR** Softkey. When the **VFR** Softkey is pressed, the pre-programmed VFR code is automatically displayed in the code field of the Transponder Data Box. Pressing the **VFR** Softkey again restores the previous identification code.

The pre-programmed VFR Code is set at the factory to 1200. If a VFR code change is required, contact a Garmin-authorized service center for configuration.

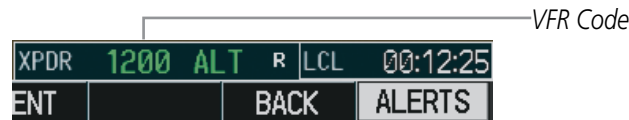

Figure 4-38 VFR Code

IDENT FUNCTION

NOTE: In Standby Mode, the **IDENT** Softkey is inoperative.

Pressing the **IDENT** Softkey sends a distinct identity indication to Air Traffic Control (ATC). The indication distinguishes the identifying transponder from all the others on the air traffic controller's screen. The **IDENT** Softkey appears on all levels of transponder softkeys. When the **IDENT** Softkey is pressed, a green IDNT indication is displayed in the mode field of the Transponder Data Box for a duration of 18 seconds.

After the **IDENT** Softkey is pressed while in Mode or Code Selection, the system reverts to the top-level softkeys.

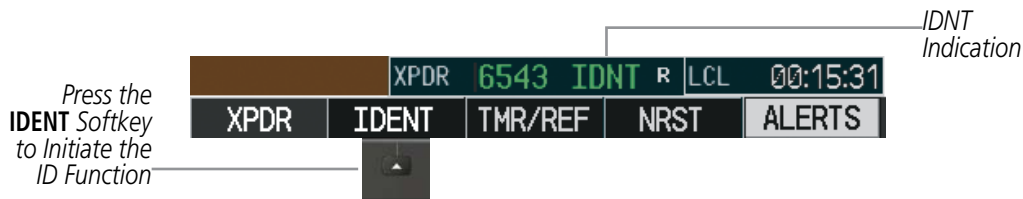

Figure 4-39 IDENT Softkey and Indication

4.5 ADDITIONAL AUDIO PANEL FUNCTIONS

POWER-UP

The Audio Panel performs a self-test during power-up. During the self-test all Audio Panel annunciator lights illuminate for approximately two seconds. Once the self-test is completed, most of the settings are restored to those in use before the unit was last turned off.

MONO/STEREO HEADSETS

Stereo headsets are recommended for use in this aircraft.

Using a monaural headset in a stereo jack shorts the right headset channel output to ground. While this does not damage the Audio Panel, a person listening on a monaural headset hears only the left channel in both ears. If a monaural headset is used at one of the passenger positions, any other passenger using a stereo headset hears audio in the left ear only.

SPEAKER

All of the radios can be heard over the cabin speaker. Pressing the **SPKR** Key selects and deselects the cabin speaker. Speaker audio is muted when the PTT is pressed. Certain aural alerts and warnings (autopilot, traffic, altitude) are always heard on the speaker, even when the speaker is not selected.

The speaker volume is adjustable within a nominal range. Contact a Garmin-authorized service center for volume adjustment.



Figure 4-40 Passenger Address and Speaker Keys

INTERCOM

The Audio Panel includes a four-position intercom system (ICS) in the 172R/S, 172TD, and (T)182T 182, and a six-position ICS in the (T)206H plus a stereo music input for the pilot, copilot and up to two passengers. The intercom provides pilot and copilot isolation from the passengers and aircraft radios.



Figure 4-41 Intercom Controls

PILOT KEY Annunciator	COPLT KEY Annunciator	Pilot Hears	Copilot Hears	Passenger Hears
OFF	OFF	Selected radios, aural alerts, pilot, copilot, passengers, music	Selected radios, aural alerts, pilot, copilot, passengers, music	Selected radios, aural alerts, pilot, copilot, passengers, music
ON	OFF	Selected radios, aural alerts, pilot	Copilot, passengers, music	Copilot, passengers, music
OFF	ON	Selected radios, aural alerts, pilot, passengers, music	Copilot	Selected radios, aural alerts, pilot, passengers, music
ON	ON	Selected radios, aural alerts, pilot, copilot	Selected radios, aural alerts, pilot, copilot	Passengers, music

Table 4-1 ICS Isolation Modes

Pilot isolation is selected when the PILOT Annunciator is illuminated. During pilot isolation, the pilot can hear the selected radios and aural alerts and warnings. The copilot and passengers can communicate with each other. The copilot is isolated from aural alerts and warnings.

Copilot isolation is selected when the COPLT Annunciator is illuminated. The copilot is isolated from the selected radios, aural alerts and warnings, and everyone else. The pilot and passengers can hear the selected radios, aural alerts, and communicate with each other.

When both the PILOT and COPLT Annunciators are illuminated, the pilot and copilot can hear the selected radios, aural alerts, and communicate with each other. The passengers are isolated from the pilot and copilot but can communicate with each other.

When both the PILOT and COPLT Annunciators are extinguished, everyone hears the selected radios, aural alerts, and is able to communicate with everyone else.

INTERCOM VOLUME AND SQUELCH

The **PILOT/PASS** Knob controls volume or manual squelch adjustment for the pilot and copilot/passenger. The small knob controls the pilot volume and squelch. The large knob controls the copilot/passenger volume and squelch. The VOL and SQ annunciators at the bottom of the unit indicate which function the knob is controlling. Pressing the **PILOT/PASS** Knob switches between volume and squelch control as indicated by the VOL or SQ annunciation being illuminated.

The **MAN SQ** Key allows either automatic or manual control of the squelch setting.

- When the MAN SQ Annunciator is extinguished (Automatic Squelch is on), the **PILOT/PASS** Knob controls only the volume (pressing the **PILOT/PASS** Knob has no effect on the VOL/SQ selection).
- When the MAN SQ Annunciator is illuminated (Manual Squelch), the **PILOT/PASS** Knob controls either volume or squelch (selected by pressing the **PILOT/PASS** Knob and indicated by the VOL or SQ annunciation).

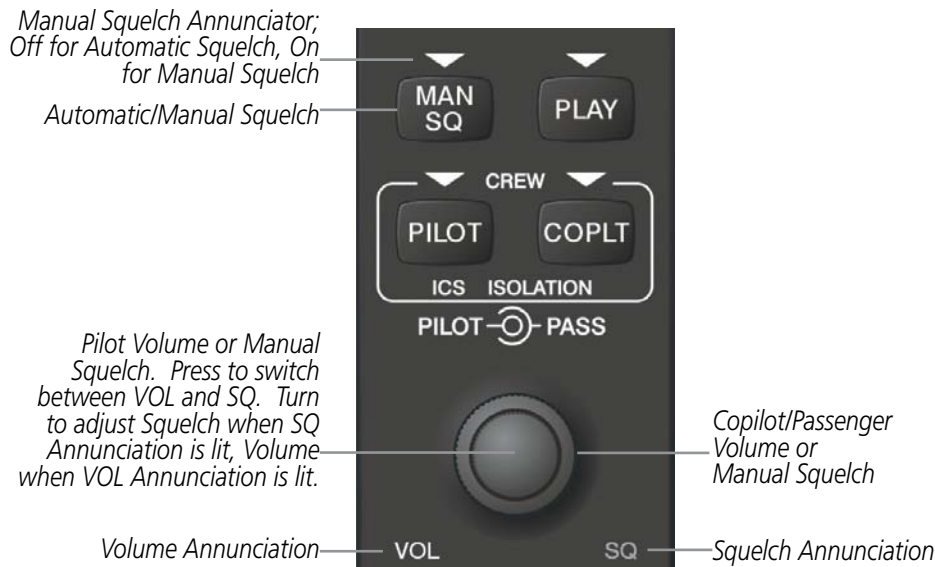

Figure 4-42 Volume/Squelch Control

PASSENGER ADDRESS (PA) SYSTEM

A passenger address system is available for delivering voice messages over the cabin speaker in the (T)182T and (T)206H only. When the **PA** Key is selected on the Audio Panel, the COM MIC Annunciator is extinguished, and the active COM frequency changes to white, indicating that there is no COM selected. A Push-to-Talk (PTT) must be pressed to deliver PA announcements. The PA Annunciator flashes about once per second while the PTT is depressed.

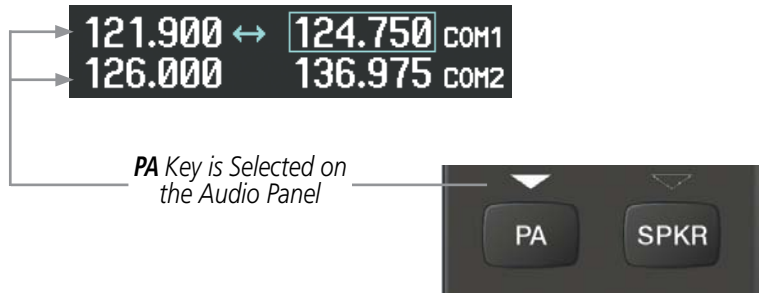

Figure 4-43 PA Key Selected for Cabin Announcements

CLEARANCE RECORDER AND PLAYER

The Audio Panel contains a digital clearance recorder that records up to 2.5 minutes of the selected COM radio signal. Recorded COM audio is stored in separate memory blocks. Once 2.5 minutes of recording time have been reached, the recorder begins recording over the stored memory blocks, starting from the oldest block.

The **PLAY** Key controls the play function. Pressing the **PLAY** Key once plays the latest recorded memory block. The PLAY Annunciator flashes to indicate when play is in progress. The PLAY Annunciator turns off after the present memory block has finished playing.

Pressing the **MKR/MUTE** Key during play of a memory block stops play. If a COM input signal is detected during play of a recorded memory block, play is halted.

Pressing the **PLAY** Key while audio is playing begins playing the previously recorded memory block. Each subsequent press of the **PLAY** Key selects the previously recorded memory block.

Powering off the unit automatically clears all recorded blocks.



Figure 4-44 Marker Mute and Play Keys

ENTERTAINMENT INPUTS

 **NOTE:** Auxiliary entertainment inputs cannot be completely turned off. Audio level for the AUX Audio In input can be adjusted by a Garmin-authorized service center.

 **NOTE:** The AUX Audio In stereo entertainment input is not controlled by the **AUX** Key on the Audio Panel. The **AUX** Key is reserved for an auxiliary radio input.

SiriusXM radio entertainment audio from the Data Link Receiver may be heard by the pilot and passengers simultaneously (optional: requires subscription to SiriusXM Satellite Radio Service). Refer to the Additional Features Section for more details on the Data Link Receiver.

A 3.5-mm stereo phone jack is installed in a convenient location for audio connection. This input, labeled AUX Audio In, is compatible with popular portable entertainment devices such as MP3 and CD players. The headphone output of the entertainment device is plugged into the jack. The current ICS state of isolation affects the distribution of the entertainment input (see Table 4-1).

Connecting a stereo input to the AUX Audio In jack removes the SiriusXM Satellite Radio Audio.

Entertainment audio can be heard by the pilot and copilot when both the PILOT and the COPLT Annunciators are extinguished. Entertainment audio can also be heard by the pilot when the COPLT Annunciator is illuminated and by the copilot when the PILOT Annunciator is illuminated. Passenger entertainment audio is never muted.

ENTERTAINMENT AUDIO MUTING

Entertainment audio muting occurs when aircraft radio or marker beacon activity is heard. Audio is always soft muted when an interruption occurs from these sources. Soft muting is the gradual return of audio to its original volume level. The time required for the volume to return to normal is between one-half and four seconds.

Pressing and holding the **MKR/MUTE** Key for three seconds switches muting of entertainment audio on and off. When switching, either one or two beeps are heard; one beep indicates that audio muting is enabled, two beeps indicate audio muting is disabled. Entertainment audio muting is reset (enabled) during power up.

4.6 AUDIO PANEL PREFLIGHT PROCEDURE

NOTE: If the pilot and/or copilot are using headsets that have a high/low switch or volume control knob, verify that the switch is in the high position and the volume control on the headsets are at maximum volume setting. On single-pilot flights, verify that all other headsets are not connected to avoid excess noise in the audio system.

NOTE: When the **MAN SQ** Key is pressed, the ICS squelch can be set manually by the pilot and copilot. If manual squelch is set to full open (SQ annunciated and the knobs turned counterclockwise) background noise is heard in the ICS system as well as during COM transmissions.

After powering up the G1000 System, the following steps aid in maximizing the use of the Audio Panel as well as prevent pilot and copilot induced issues. These preflight procedures should be performed each time a pilot boards the aircraft to insure awareness of all audio levels in the Audio Panel and radios.

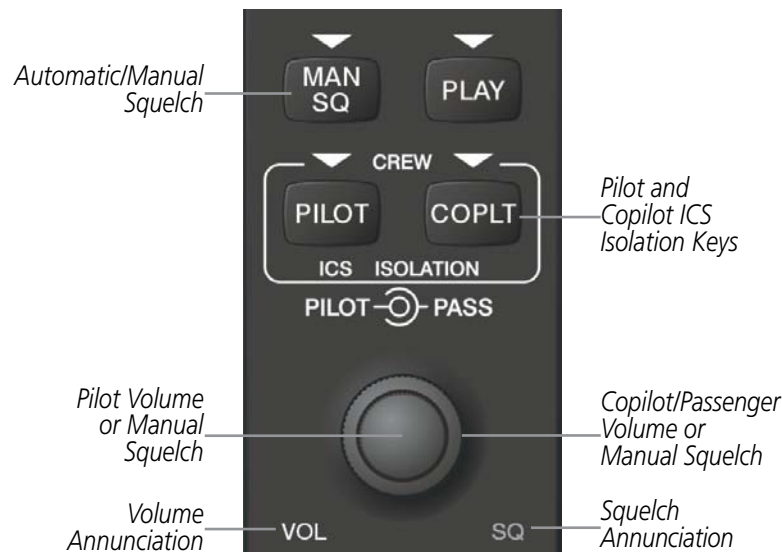

Figure 4-45 Audio Panel Controls

Setting the Audio Panel during preflight:

- 1) Verify that the PILOT and COPLT Annunciators are extinguished.
- 2) Verify that manual squelch is set to full open.
- 3) Turn the **PILOT/PASS** Knobs clockwise two full turns. This sets the headset intercom audio level to max volume (least amount of attenuation).
- 4) Adjust radio volume levels (COM, NAV, etc.) to a suitable level.
- 5) Adjust the **PILOT/PASS** Knob volume to the desired intercom level.
- 6) Reset squelch to automatic, or adjust to the appropriate level manually.

Once this procedure has been completed, the pilot and copilot can change settings, keeping in mind the notes above.

4.7 ABNORMAL OPERATION

Abnormal operation of the G1000 includes equipment failures of the G1000 components and failure of associated equipment, including switches and external devices.

STUCK MICROPHONE

If the push-to-talk (PTT) Key becomes stuck, the COM transmitter stops transmitting after 35 seconds of continuous operation. An alert appears on the PFD to advise the pilot of a stuck microphone.

The **COM1 MIC** or **COM2 MIC** Key Annunciator on the Audio Panel flashes as long as the PTT Key remains stuck.

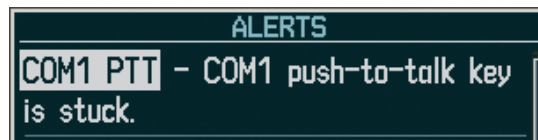

Figure 4-46 Stuck Microphone Alert

COM TUNING FAILURE

In case of a COM system tuning failure, the emergency frequency (121.500 MHz) is automatically tuned in the radio in which the tuning failure occurred. Depending on the failure mode, a red X may appear on the frequency display.



Figure 4-47 COM Tuning Failure

AUDIO PANEL FAIL-SAFE OPERATION

If there is a failure of the Audio Panel, a fail-safe circuit connects the pilot's headset and microphone directly to the COM1 transceiver. Audio is not available on the speaker during Fail-safe operation.

REVERSIONARY MODE

The red **DISPLAY BACKUP** Button selects the Reversionary Mode. See the System Overview Section for more information on Reversionary Mode.



Figure 4-48 Display Backup Button

SYSTEM OVERVIEW

FLIGHT INSTRUMENTS

EIS

AUDIO PANEL & CNS

FLIGHT MANAGEMENT

HAZARD AVOIDANCE

AFCS

ADDITIONAL FEATURES

APPENDICES

INDEX

BLANK PAGE

SECTION 5 FLIGHT MANAGEMENT

5.1 INTRODUCTION

The G1000 is an integrated flight, engine, communication, navigation and surveillance system. This section of the Pilot's Guide explains flight management using the G1000.

The most prominent part of the G1000 are the two full color displays: one Primary Flight Display (PFD) and one Multi Function Display (MFD). The information to successfully navigate the aircraft using the GPS sensors is displayed on the PFD and the MFD. See examples in the Figure 5-1 and Figure 5-2. Detailed descriptions of GPS navigation functions are discussed later in this section.

A brief description of the GPS navigation data on the PFD and MFD follows.

Navigation mode indicates which sensor is providing the course data (e.g., GPS, VOR) and the flight plan phase (e.g., Departure (DPRT), Terminal (TERM), Enroute (ENR), Oceanic (OCN), Approach (LNAV, LNAV+V, L/VNAV, or LPV), or Missed Approach (MAPR)). L/VNAV and LPV approaches are only available with SBAS.

The Inset Map is a small version of the MFD Navigation Map and can be displayed in the lower left corner of the PFD. When the system is in reversionary mode, the Inset Map is displayed in the lower right corner. The Inset Map is displayed by pressing the **INSET** Softkey. Pressing the **INSET** Softkey again, then pressing the **OFF** Softkey removes the Inset Map.

The Navigation Map displays aviation data (e.g., airports, VORs, airways, airspaces), geographic data (e.g., cities, lakes, highways, borders), topographic data (map shading indicating elevation), and hazard data (e.g., traffic, terrain, weather). The amount of displayed data can be reduced by pressing the **DCLTR** Softkey. The Navigation Map can be oriented four different ways: North Up (NORTH UP), Track Up (TRK UP), Desired Track Up (DTK UP), or Heading Up (HDG UP).

An aircraft icon is placed on the Navigation Map at the location corresponding to the calculated present position. The aircraft position and the flight plan legs are accurately based on GPS calculations. The basemap upon which these are placed are from a source with less resolution, therefore the relative position of the aircraft to map features is not exact. The leg of the active flight plan currently being flown is shown as a magenta line on the navigation map. The other legs are shown in white.

There are 28 different map ranges available, from 500 feet to 2000 nm. The current range is indicated in the lower right corner of the map and represents the top-to-bottom distance covered by the map. To change the map range on any map, turn the **Joystick** counter-clockwise to zoom in (-, decreasing), or clockwise to zoom out (+, increasing).

The Direct-to Window, the Flight Plan Window, the Procedures Window, and the Nearest Airports Window can be displayed in the lower right corner of the PFD. Details of these windows are discussed in detail later in the section.

- SYSTEM OVERVIEW
- FLIGHT INSTRUMENTS
- EIS
- AUDIO PANEL & CNS
- FLIGHT MANAGEMENT
- HAZARD AVOIDANCE
- AFCS
- ADDITIONAL FEATURES
- APPENDICES
- INDEX



Figure 5-1 GPS Navigation Information on the PFD

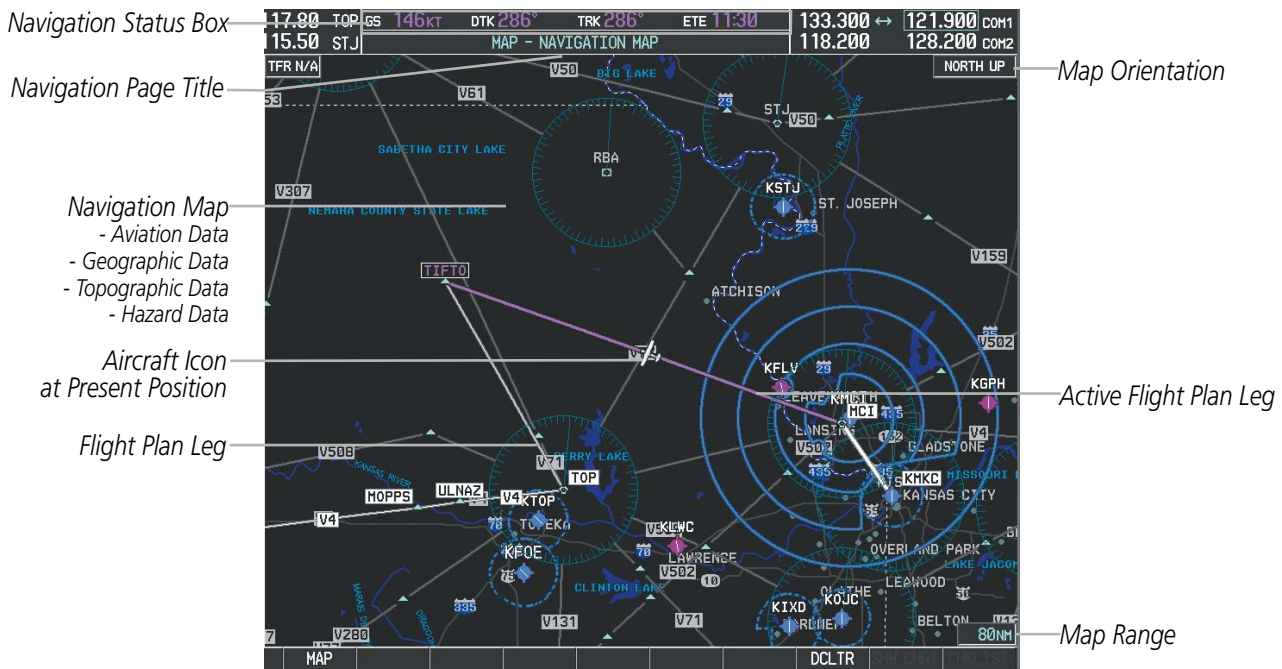

Figure 5-2 GPS Navigation Information on the MFD Navigation Page

NAVIGATION STATUS BOX

The Navigation Status Box located at the top of the PFD contains two fields displaying the following information:



PFD Navigation Status Box

- Active flight plan leg (e.g., ‘D-> KICT’ or ‘KIXD -> KCOS’) **or** flight plan annunciations (e.g., ‘Turn right to 021° in 8 seconds’)
- Distance (DIS) and Bearing (BRG) to the next waypoint **or** flight plan annunciations (e.g., ‘TOD within 1 minute’)

The symbols used in the PFD status bar are:

Symbol	Description
	Active Leg
	Direct-to
	Right Procedure Turn
	Left Procedure Turn
	Right Holding Pattern
	Left Holding Pattern
	Vector to Final
	Right DME Arc
	Left DME Arc

The Navigation Status Box located at the top of the MFD contains four data fields, each displaying one of the following items:

- Bearing (BRG)
- Distance (DIS)
- Desired Track (DTK)
- Endurance (END)
- Enroute Safe Altitude (ESA)
- Estimated Time of Arrival (ETA)
- Estimated Time Enroute (ETE)
- Fuel on Board (FOB)
- Fuel over Destination (FOD)
- Ground Speed (GS)
- Minimum Safe Altitude (MSA)
- True Air Speed (TAS)
- Track Angle Error (TKE)
- Track (TRK)
- Vertical Speed Required (VSR)
- Crosstrack Error (XTK)



MFD Navigation Status Box

The navigation information displayed in the four data fields can be selected on the MFD Data Bar Fields Box on the AUX - System Setup Page. The default selections (in order left to right) are GS, DTK, TRK, and ETE.

Changing a field in the MFD Navigation Status Box:

- 1) Select the System Setup Page.
- 2) Press the **FMS** Knob momentarily to activate the flashing cursor.
- 3) Turn the large **FMS** Knob to highlight the desired field number in the MFD Data Bar Fields Box.
- 4) Turn the small **FMS** Knob to display and scroll through the data options list.
- 5) Select the desired data.
- 6) Press the **ENT** Key. Pressing the **DFLTS** Softkey returns all fields to the default setting.

5.2 USING MAP DISPLAYS

Map displays are used extensively in the G1000 to provide situational awareness in flight. Most G1000 maps can display the following information:

- Airports, NAVAIDs, airspaces, airways, land data (highways, cities, lakes, rivers, borders, etc.) with names
- Map Pointer information (distance and bearing to pointer, location of pointer, name, and other pertinent information)
- Map range
- Wind direction and speed
- Map orientation
- Icons for enabled map features
- Aircraft icon (representing present position)
- Nav range ring
- Fuel range ring
- Flight plan legs
- User waypoints
- Track vector
- Topography scale
- Topography data
- Obstacle data

The information in this section applies to the following maps unless otherwise noted:

- All Map Group Pages (MAP)
- All Waypoint Group Pages (WPT)
- AUX - Trip Planning
- All Nearest Group Pages (NRST)
- Flight Plan Pages (FPL)
- Direct-to Window
- PFD Inset Map
- Procedure Loading Pages

MAP ORIENTATION

Maps are shown in one of four different orientation options, allowing flexibility in determining aircraft position relative to other items on the map (north up) or for determining where map items are relative to where the aircraft is going (track up, desired track up, or heading up). The map orientation is shown in the upper right corner of the map.

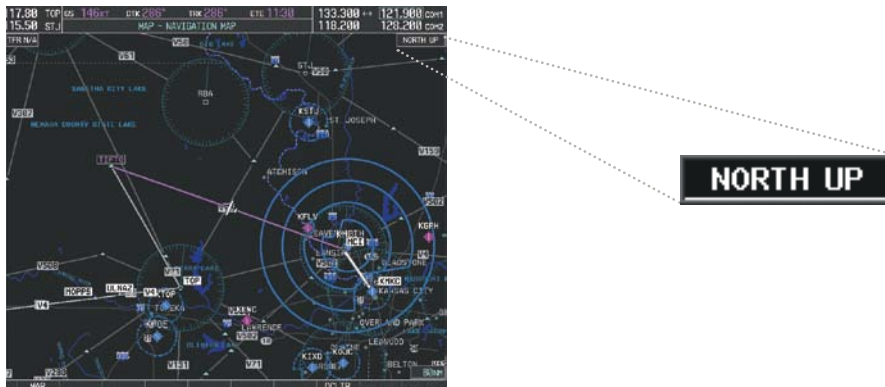

Figure 5-3 Map Orientation

- North up (NORTH UP) aligns the top of the map display to north (default setting).
- Track up (TRK UP) aligns the top of the map display to the current ground track.

- Desired track up (DTK UP) aligns the top of the map display to the desired course.
- Heading up (HDG UP) aligns the top of the map display to the current aircraft heading.

NOTE: When panning or reviewing active flight plan legs in a non-North Up orientation, the map does not show the map orientation nor the wind direction and speed.

NOTE: Map orientation can only be changed on the Navigation Map Page. Any other displays that show navigation data reflect the orientation selected for the Navigation Map Page:

Changing the Navigation Map orientation:

- 1) With the Navigation Map Page displayed, press the **MENU** Key. The cursor flashes on the 'Map Setup' option.

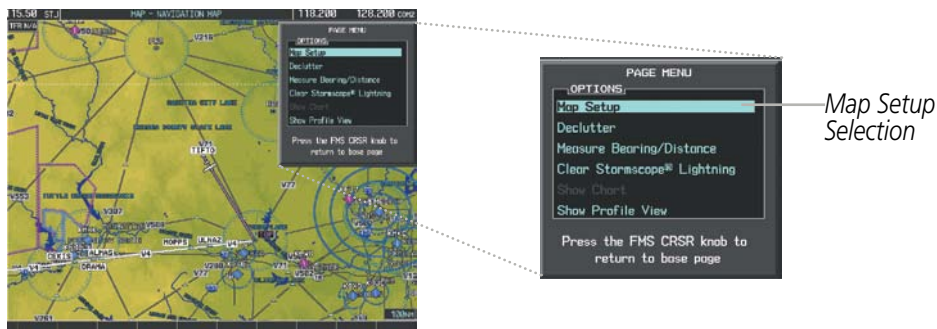

Figure 5-4 Navigation Map Page Menu Window

- 2) Press the **ENT** Key to display the Map Setup Window.
- 3) Turn the large **FMS** Knob, or press the **ENT** Key once, to select the 'ORIENTATION' field.



Figure 5-5 Map Setup Menu Window - Map Group

- 4) Turn the small **FMS** Knob to select the desired orientation.
- 5) Press the **ENT** Key to select the new orientation.
- 6) Press the **FMS** Knob to return to the base page.

MAP RANGE

There are 28 different map ranges available, from 500 feet to 2000 nm. The current range is indicated in the lower right corner of the map and represents the top-to-bottom distance covered by the map. When the map range is decreased to a point that exceeds the capability of the G1000 to accurately represent the map, a magnifying glass icon is shown to the left of the map range. To change the map range turn the **Joystick** counter-clockwise to decrease the range, or clockwise to increase the range.



Figure 5-6 Map Range

AUTO ZOOM

Auto zoom allows the G1000 to change the map display range to the smallest range clearly showing the active waypoint. Auto zoom can be overridden by adjusting the range with the Joystick, and remains until the active waypoint changes, a terrain or traffic alert occurs, the aircraft takes off, or the manual override times out (timer set on Map Setup Window).

If a terrain caution or warning occurs, any map page displaying TAWS/TERRAIN data automatically adjusts to the smallest map range clearly showing the highest priority alert. If a new traffic advisory alert occurs, any map page capable of displaying traffic advisory alerts automatically adjusts to the smallest map range clearly showing the traffic advisory. When terrain or traffic alerts clear, the map returns to the previous auto zoom range based on the active waypoint.

The auto zoom function can be turned on or off independently for the PFD and MFD. Control of the ranges at which the auto zoom occurs is done by setting the minimum and maximum 'look forward' times (set on the Map Setup Window for the Map Group). These settings determine the minimum and maximum distance to display based upon the aircraft's ground speed.

- Waypoints that are long distances apart cause the map range to increase to a point where many details on the map are decluttered. If this is not acceptable, lower the maximum look ahead time to a value that limits the auto zoom to an acceptable range.
- Waypoints that are very short distances apart cause the map range to decrease to a point where situational awareness may not be what is desired. Increase the minimum look ahead time to a value that limits the auto zoom to a minimum range that provides acceptable situational awareness.

- Flight plans that have a combination of long and short legs cause the range to increase and decrease as waypoints sequence. To avoid this, auto zoom can be disabled or the maximum/minimum times can be adjusted.
- The ‘time out’ time (configurable on the Map Setup Page for the Map Group) determines how long auto zoom is overridden by a manual adjustment of the range knob. At the expiration of this time, the auto zoom range is restored. Setting the ‘time out’ value to zero causes the manual override to never time out.
- When the maximum ‘look forward’ time is set to zero, the upper limit becomes the maximum range available (2000 nm).
- When the minimum ‘look forward’ time is set to zero, the lower limit becomes 1.5 nm.

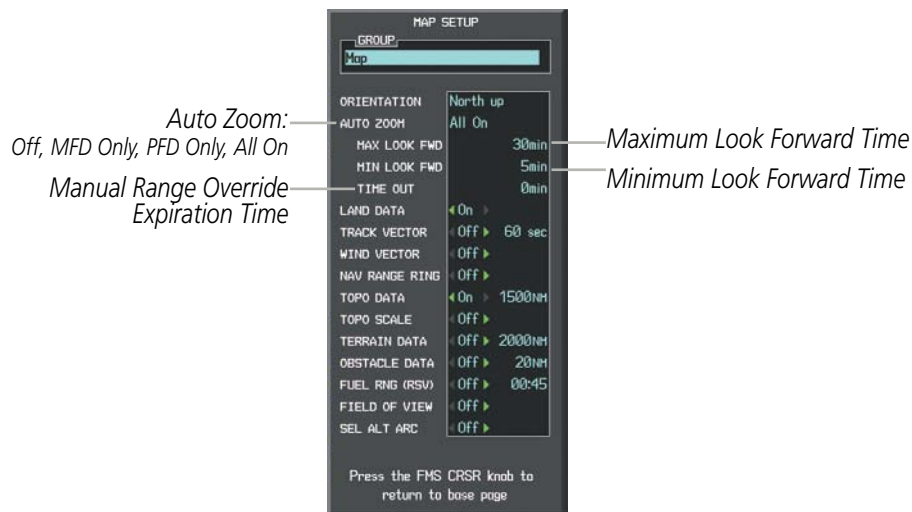

Figure 5-7 Map Setup Menu Window - Map Group, Auto Zoom

Configuring automatic zoom:

- 1) Press the **MENU** Key with the Navigation Map Page displayed. The cursor flashes on the ‘Map Setup’ option.
- 2) Press the **ENT** Key. The Map Setup Menu is displayed.
- 3) Select the ‘Map’ group.
- 4) Press the **ENT** Key.
- 5) Highlight the ‘AUTO ZOOM’ field.
- 6) Select ‘Off’, ‘MFD Only’, ‘PFD Only’, or ‘ALL On’.
- 7) Press the **ENT** Key to accept the selected option. The flashing cursor highlights the ‘MAX LOOK FWD’ field. Times are from zero to 999 minutes.
- 8) Use the **FMS** Knobs to set the time. Press the **ENT** Key.
- 9) Repeat step 8 for ‘MIN LOOK FWD’ (zero to 99 minutes) and ‘TIME OUT’ (zero to 99 minutes).
- 10) Press the **FMS** Knob to return to the Navigation Map Page.

MAP PANNING

Map panning allows the pilot to:

- View parts of the map outside the displayed range without adjusting the map range
- Highlight and select locations on the map
- Review information for a selected airport, NAVAID or user waypoint
- Designate locations for use in flight planning
- View airspace and airway information

When the panning function is selected by pressing the **Joystick**, the Map Pointer flashes on the map display. A window also appears at the top of the map display showing the latitude/longitude position of the pointer, the bearing and distance to the pointer from the aircraft's present position, and the elevation of the land at the position of the pointer.



Figure 5-8 Navigation Map - Map Pointer Activated



NOTE: The map is normally centered on the aircraft's position. If the map has been panned and there has been no pointer movement for about 60 seconds, the map reverts back to centered on the aircraft position and the flashing pointer is removed.

When the Map Pointer is placed on an object, the name of the object is highlighted (even if the name was not originally displayed on the map). When any map feature or object is selected on the map display, pertinent information is displayed.

Information about Point of Interest



Map Pointer on POI

Figure 5-9 Navigation Map - Map Pointer on Point of Interest

When the Map Pointer crosses an airspace boundary, the boundary is highlighted and airspace information is shown at the top of the display. The information includes the name and class of airspace, the ceiling in feet above Mean Sea Level (MSL), and the floor in feet MSL.

Information about Airspace



Map Pointer on Airspace

Figure 5-10 Navigation Map - Map Pointer on Airspace

Panning the map:

- 1) Press the **Joystick** to display the Map Pointer.
- 2) Move the **Joystick** to move the Map Pointer around the map.
- 3) Press the **Joystick** to remove the Map Pointer and recenter the map on the aircraft's current position.

Reviewing information for an airport, NAVAID, or user waypoint:

- 1) Place the Map Pointer on a waypoint.
- 2) Press the **ENT** Key to display the Waypoint Information Page for the selected waypoint.
- 3) Press the **GO BACK** Softkey, the **CLR** Key, or the **ENT** Key to exit the Waypoint Information Page and return to the Navigation Map showing the selected waypoint.

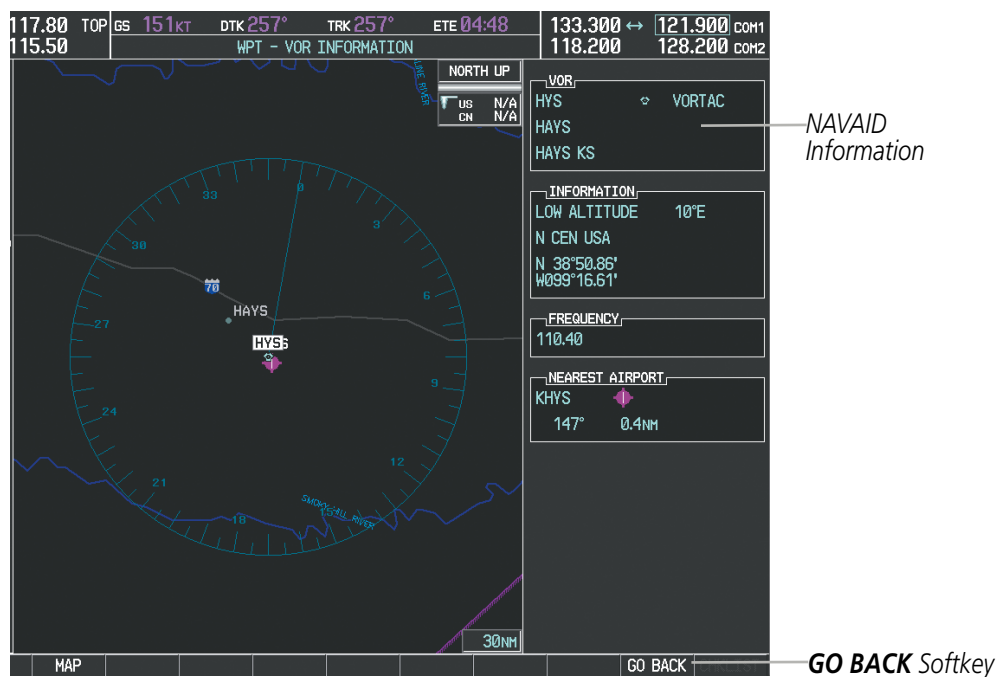

Figure 5-11 Navigation Map - Information Window - NAVAID

Viewing airspace information for a special-use or controlled airspace:

- 1) Place the Map Pointer on an open area within the boundaries of an airspace.
- 2) Press the **ENT** Key to display an options menu.
- 3) 'Review Airspaces' should already be highlighted, if not select it. Press the **ENT** Key to display the Airspace Information Page for the selected airspace.
- 4) Press the **CLR** or **ENT** Key to exit the Airspace Information Page.

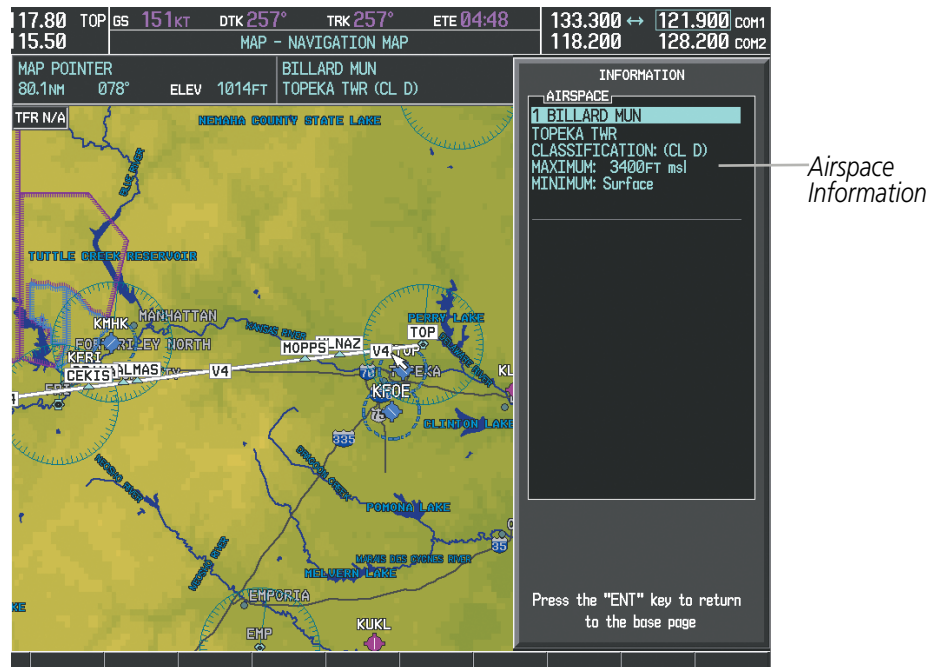

Figure 5-12 Navigation Map - Information Window - Airspace

MEASURING BEARING AND DISTANCE

Distance and bearing from the aircraft's present position to any point on the viewable navigation map may be calculated using the 'Measure Bearing and Distance' selection from Navigation Map page menu. The bearing and distance tool displays a dashed Measurement Line and a Measure Pointer to aid in graphically identifying points with which to measure. Lat/Long, distance and elevation data for the Measure Pointer is provided in a window at the top of the navigation map.

Measuring bearing and distance between any two points:

- 1) Press the **MENU** Key (with the Navigation Map Page displayed).
- 2) Highlight the 'Measure Bearing/Distance' field.
- 3) Press the **ENT** Key. A Measure Pointer is displayed on the map at the aircraft's present position.
- 4) Move the **Joystick** to place the reference pointer at the desired location. The bearing and distance are displayed at the top of the map. Elevation at the current pointer position is also displayed. Pressing the **ENT** Key changes the starting point for measuring.
- 5) To exit the Measure Bearing/Distance option, press the **Joystick**; or select 'Stop Measuring' from the Page Menu and press the **ENT** Key.



Figure 5-13 Navigation Map - Measuring Bearing and Distance

TOPOGRAPHY

All navigation maps can display various shades of topography colors representing land elevation, similar to aviation sectional charts. Topographic data can be displayed or removed as described in the following procedures. Topographic data can also be displayed on the selectable profile map at the bottom of the navigation map.

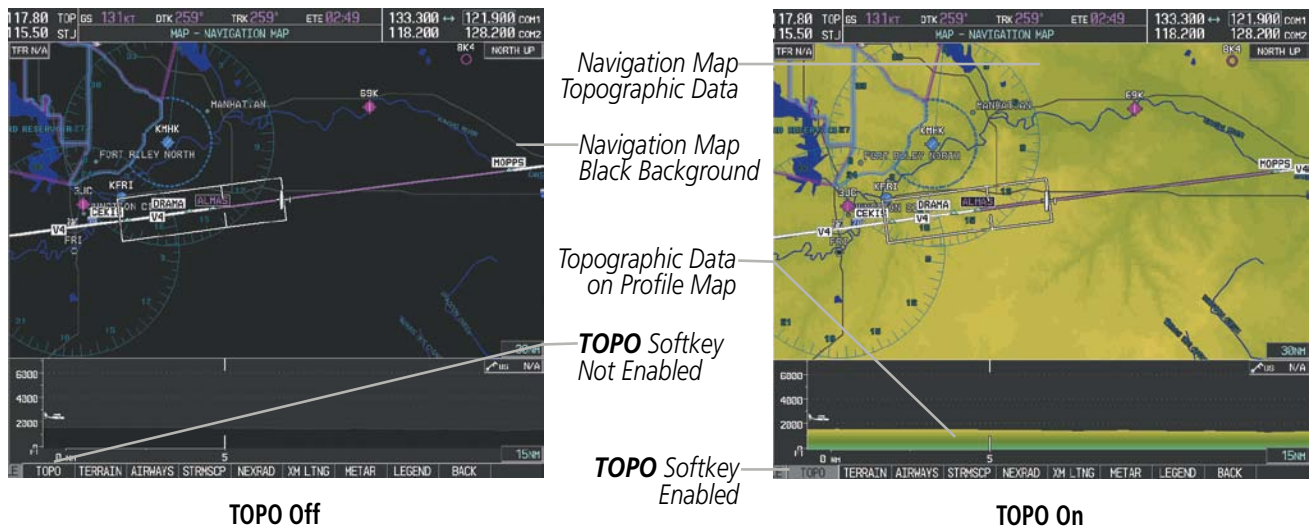

Figure 5-14 Navigation Map - Topographic Data

Displaying/removing topographic data on all pages displaying navigation maps:

- 1) Press the **MAP** Softkey (the **INSET** Softkey for the PFD Inset Map).
- 2) Press the **TOPO** Softkey.
- 3) Press the **TOPO** Softkey again to remove topographic data from the Navigation Map. When topographic data is removed from the page, all navigation data is presented on a black background.

Displaying/removing topographic data (TOPO DATA) using the Navigation Map Page Menu:

- 1) Press the **MENU** Key with the Navigation Map Page displayed. The cursor flashes on the 'Map Setup' option.
- 2) Press the **ENT** Key. The Map Setup Menu is displayed.
- 3) Select the 'Map' group.
- 4) Press the **ENT** Key.
- 5) Highlight the 'TOPO DATA' field.
- 6) Select 'On' or 'Off'.
- 7) Press the **FMS** Knob to return to the Navigation Map Page.



Figure 5-15 Navigation Map Setup Menu - TOPO DATA Setup

The topographic data range is the maximum map range on which topographic data is displayed.



NOTE: Since the PFD Inset Map is much smaller than the MFD navigation maps, items are removed on the PFD Inset Map two range levels smaller than the range selected in the Map Setup pages (e.g., a setting of 100 nm removes the item at ranges above 100 nm on MFD navigation maps, while the PFD Inset Map removes the same item at 50 nm).

Selecting a topographical data range (TOPO DATA):

- 1) Press the **MENU** Key with the Navigation Map Page displayed. The cursor flashes on the 'Map Setup' option.
- 2) Press the **ENT** Key. The Map Setup Menu is displayed.
- 3) Select the 'Map' group.
- 4) Press the **ENT** Key.
- 5) Highlight the 'TOPO DATA' range field. TOPO ranges are from 500 ft to 2000 nm.
- 6) To change the TOPO range setting, turn the small **FMS** Knob to display the range list.
- 7) Select the desired range using the small **FMS** Knob.
- 8) Press the **ENT** Key.
- 9) Press the **FMS** Knob to return to the Navigation Map Page.

In addition, the Navigation Map can display a topographic scale (located in the lower right hand side of the map) showing a scale of the terrain elevation and current elevation values.

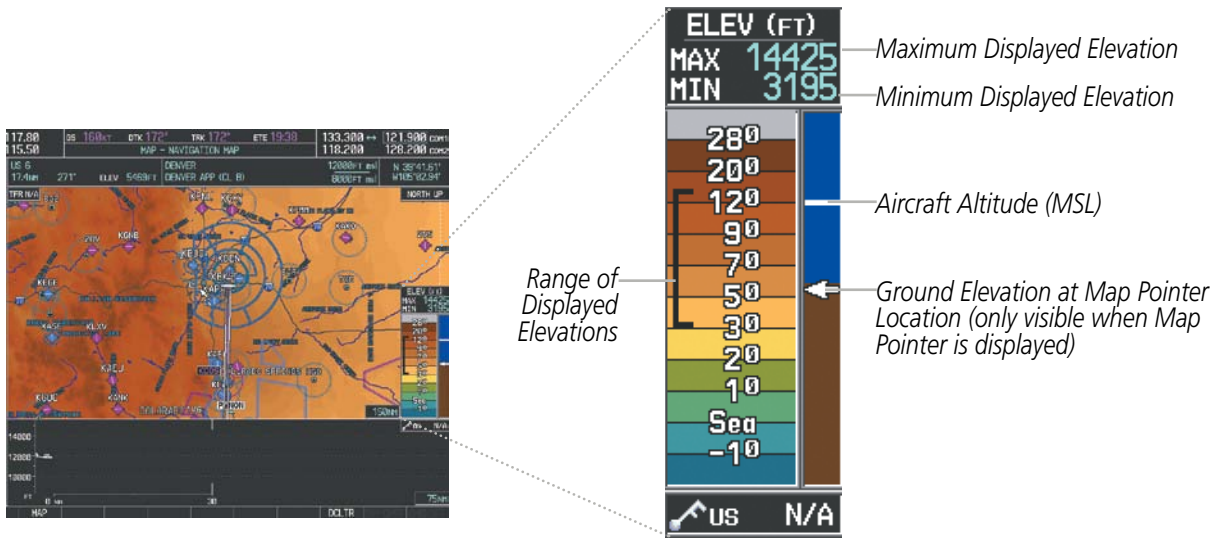

Figure 5-16 Navigation Map - TOPO SCALE

Displaying/removing the topographic scale (TOPO SCALE):

- 1) Press the **MENU** Key with the Navigation Map Page displayed. The cursor flashes on the 'Map Setup' option.
- 2) Press the **ENT** Key. The Map Setup Menu is displayed.
- 3) Select the 'Map' group and press the **ENT** Key.
- 4) Highlight the 'TOPO SCALE' field.
- 5) Select 'On' or 'Off'.
- 6) Press the **FMS** Knob to return to the Navigation Map Page.

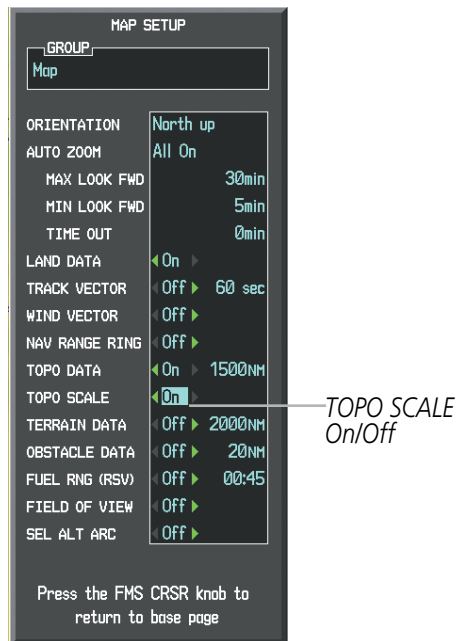

Figure 5-17 Navigation Map Setup Menu - TOPO SCALE Setup

MAP SYMBOLS

This section discusses the types of land and aviation symbols that can be displayed. Each listed type of symbol can be turned on or off, and the maximum range to display each symbol can be set. The decluttering of the symbols from the map using the **DCLTR** Softkey is also discussed.

LAND SYMBOLS

The following items are configured on the land menu:

Land Symbols <i>(Text label size can be None, Small, Medium (Med), or Large (Lrg))</i>	Symbol	Default Range (nm)	Maximum Range (nm)
Latitude/Longitude (LAT/LON)		Off	2000
Highways and Roads			
Interstate Highway (FREEWAY)		300	800
International Highway (FREEWAY)		300	800
US Highway (NATIONAL HWY)		30	80
State Highway (LOCAL HWY)		15	30
Local Road (LOCAL ROAD)	N/A	8	15
Railroads (RAILROAD)		15	30
LARGE CITY (> 200,000)		800	1500
MEDIUM CITY (> 50,000)		100	200
SMALL CITY (> 5,000)		20	50
States and Provinces (STATE/PROV)		800	1500
Rivers and Lakes (RIVER/LAKE)		200	500
USER WAYPOINT		150	300

Table 5-1 Land Symbol Information

AVIATION SYMBOLS

The following items are configured on the aviation menu:













Aviation Symbols <i>(Text label size can be None, Small, Medium (Med), or Large (Lrg))</i>	Symbol	Default Range (nm)	Maximum Range (nm)
Active Flight Plan Leg (ACTIVE FPL)		2000	2000
Non-active Flight Plan Leg (ACTIVE FPL)		2000	2000
Active Flight Plan Waypoint (ACTIVE FPL WPT)	See Airports, NAVAIDs	2000	2000
Large Airports (LARGE APT)		250	500
Medium Airports (MEDIUM APT)		150	300
Small Airports (SMALL APT)		50	100
Taxiways (SAFETAXI)	See Additional Features	3	20
Runway Extension (RWY EXTENSION)	N/A	Off	100
Intersection (INT WAYPOINT)		15	30
Non-directional Beacon (NDB WAYPOINT)		15	30
VOR (VOR WAYPOINT)		150	300
Class B Airspace/TMA (CLASS B/TMA)		200	500
Class C Airspace/TCA (CLASS C/TCA)		200	500
Class D Airspace (CLASS D)		150	300
Restricted Area (RESTRICTED)		200	500
Military Operations Area [MOA(MILITARY)]		200	500
Other/Air Defense Interdiction Zone (OTHER/ADIZ)		200	500
Temporary Flight Restriction (TFR)		500	2000

Table 5-2 Aviation Symbol Information

SYMBOL SETUP

All pages with maps can display land symbols (roads, lakes, borders, etc). Land symbols can be removed totally (turned off).

Displaying/removing all land symbols:

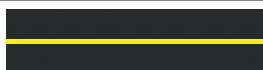
- 1) Press the **MENU** Key with the Navigation Map Page displayed. The Page Menu is displayed and the cursor flashes on the 'Map Setup' option.
- 2) Press the **ENT** Key. The Map Setup Group Menu is displayed and the cursor flashes on the 'Map' option.
- 3) Highlight the 'LAND DATA' field.
- 4) Select 'On' or 'Off'.
- 5) Press the **FMS** Knob to return to the Navigation Map Page.

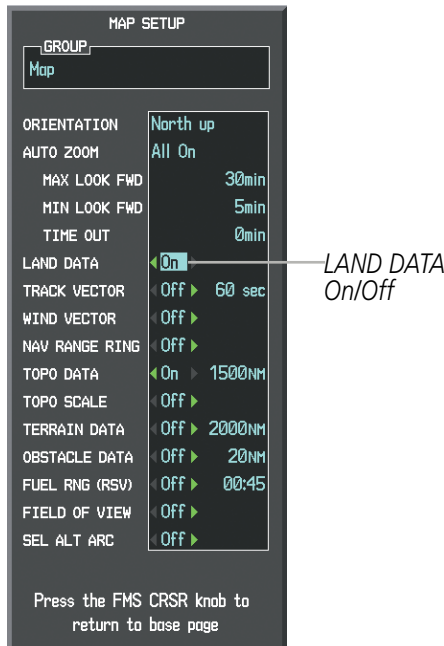

Figure 5-18 Navigation Map Setup Menu - LAND DATA Setup

The label size (TEXT) sets the size at which labels appear on the display (none, small, medium, and large). The range (RNG) sets the maximum range at which items appear on the display.

Selecting a 'Land' or 'Aviation' group item text size and range:

- 1) Press the **MENU** Key with the Navigation Map Page displayed. The cursor flashes on the 'Map Setup' option.
- 2) Press the **ENT** Key. The Map Setup Menu is displayed.
- 3) Select the 'Land' or 'Aviation' group.
- 4) Press the **ENT** Key. The cursor flashes on the first field.
- 5) Select the desired land option.
- 6) Select the desired text size.

- 7) Press the **ENT** Key to accept the selected size.
- 8) Select the desired range.
- 9) Press the **ENT** Key to accept the selected range.
- 10) Press the **FMS** Knob to return to the Navigation Map Page.

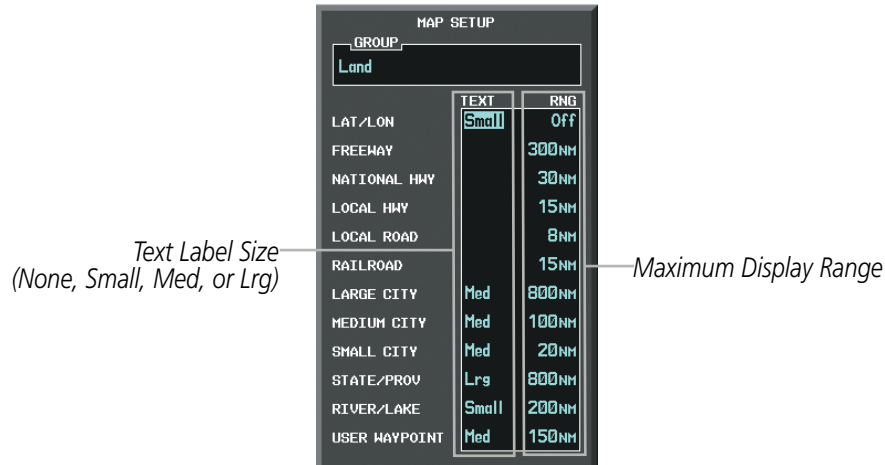

Figure 5-19 Navigation Map Setup Menu - LAND GROUP Setup

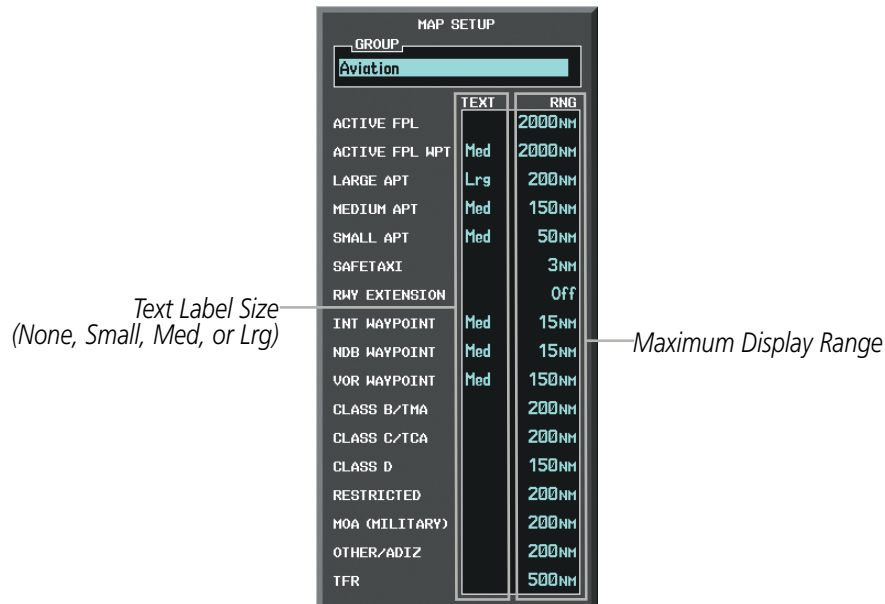

Figure 5-20 Navigation Map Setup Menu - AVIATION GROUP Setup



NOTE: Since the PFD Inset Map is much smaller than the MFD navigation maps, items are removed on the PFD Inset Map two range levels smaller than the range selected in the Map Setup pages (e.g., a setting of 100 nm removes the item at ranges above 100 nm on MFD navigation maps, while the PFD Inset Map removes the same item at 50 nm).

MAP DECLUTTER

The declutter feature allows the pilot to progressively step through four levels of removing map information. The declutter level is displayed in the **DCLTR** Softkey and next to the Declutter Menu Option.

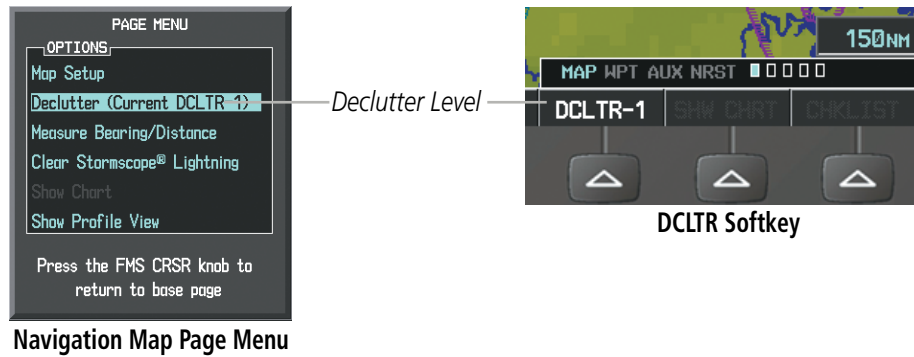

Figure 5-21 Navigation Map - Declutter Level Indications

Decluttering the map:

Press the **DCLTR** Softkey with the Navigation Map Page displayed. The current declutter level is shown. With each softkey selection, another level of map information is removed.

Or:

- 1) Press the **MENU** Key with the Navigation Map Page displayed.
- 2) Select 'Declutter'. The current declutter level is shown.
- 3) Press the **ENT** Key.

Decluttering the PFD Inset Map:

- 1) Press the **INSET** Softkey.
- 2) Press the **DCLTR** Softkey. The current declutter level is shown. With each selection, another level of map information is removed.

Table 5-3 lists the items displayed at each declutter level. The 'X' represents map items displayed for the various levels of declutter.

Item	No Declutter	Declutter-1	Declutter-2	Declutter-3
Flight Plan Route Lines	X	X	X	X
Flight Plan Route Waypoints	X	X	X	X
Rivers/Lakes	X	X	X	X
Topography Data	X	X	X	X
International Borders	X	X	X	X
Track Vector	X	X	X	X
Navigation Range Ring	X	X	X	X
Fuel Range Ring	X	X	X	X
Terrain Data	X	X	X	X
Traffic	X	X	X	X
Airways	X	X	X	X
NEXRAD	X	X	X	
XM Lightning Data	X	X	X	
Airports	X	X	X	
Runway Labels	X	X	X	
Restricted	X	X	X	
MOA (Military)	X	X	X	
User Waypoints	X	X		
Latitude/Longitude Grid	X	X		
NAVAIDs	X	X		
Class B Airspaces/TMA	X	X		
Class C Airspaces/TCA	X	X		
Class D Airspaces	X	X		
Other Airspaces/ADIZ	X	X		
TFRs	X	X		
Obstacles	X	X		
Land/Country Text	X			
Cities	X			
Roads	X			
Railroads	X			
State/Province Boundaries	X			
River/Lake Names	X			

Table 5-3 Navigation Map Items Displayed by Declutter Level

SYSTEM OVERVIEW

FLIGHT INSTRUMENTS

EIS

AUDIO PANEL & CNS

FLIGHT MANAGEMENT

HAZARD AVOIDANCE

AFCS

ADDITIONAL FEATURES

APPENDICES

INDEX

AIRWAYS

This airways discussion is based upon the North American airway structure. The airway structure in places other than North America vary by location, etc. and are not discussed in this book. Low Altitude Airways (or Victor Airways) primarily serve smaller piston-engine, propeller-driven airplanes on shorter routes and at lower altitudes. Airways are eight nautical miles wide and start 1,200 feet above ground level (AGL) and extend up to 18,000 feet mean sea level (MSL). Low Altitude Airways are designated with a “V” before the airway number (hence the name “Victor Airways”) since they run primarily between VORs.

High Altitude Airways (or Jet Routes) primarily serve airliners, jets, turboprops, and turbocharged piston aircraft operating above 18,000 feet MSL. Jet Routes start at 18,000 feet MSL and extend upward to 45,000 feet MSL (altitudes above 18,000 feet are called “flight levels” and are described as FL450 for 45,000 feet MSL). Jet Routes are designated with a “J” before the route number.

Low Altitude Airways are drawn in gray (the same shade used for roads). High Altitude Airways are drawn in green. When both types of airways are displayed, High Altitude Airways are drawn on top of Low Altitude Airways.

When airways are selected for display on the map, the airway waypoints (VORs, NDBs and Intersections) are also displayed.

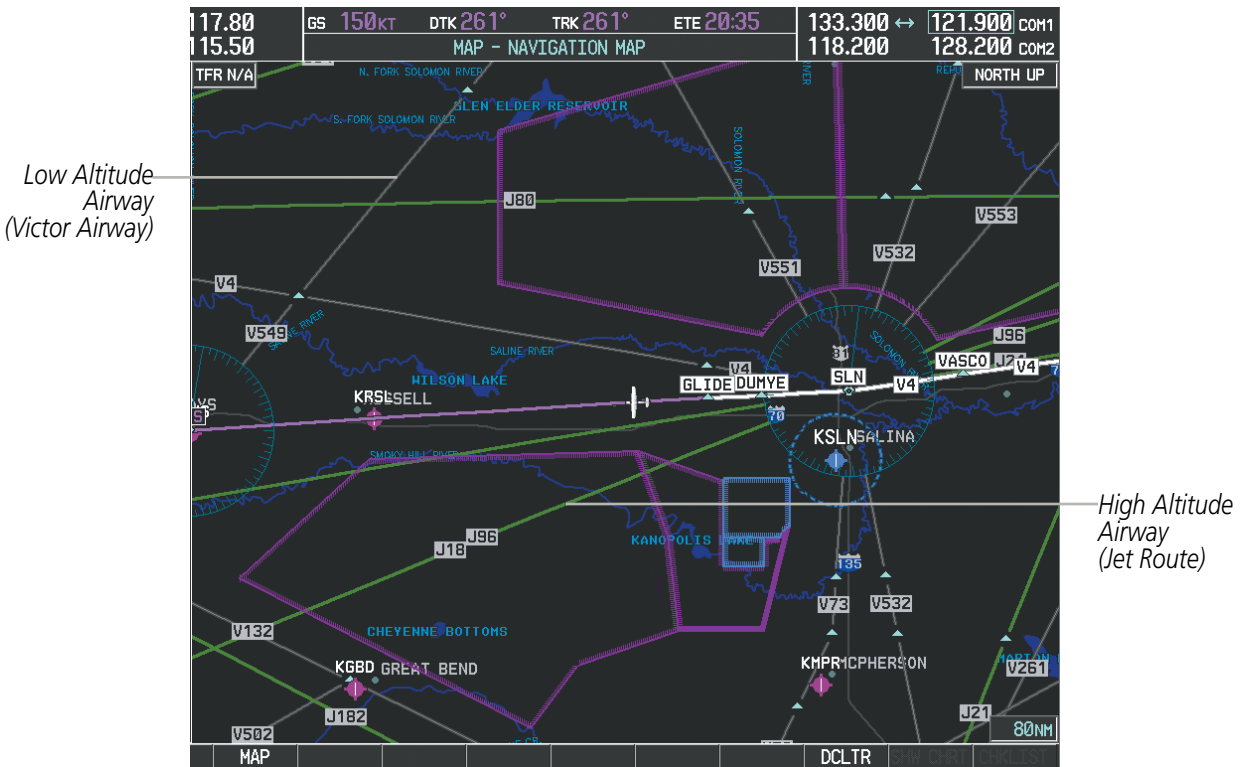

Figure 5-22 Airways on MFD Navigation Page

Airways may be displayed on the map at the pilot's discretion using either a combination of **AIRWAYS** Softkey presses, or menu selections using the **MENU** Key from the Navigation Map Page. The Airway range can also be programmed to only display Airways on the MFD when the map range is at or below a specific number.

Displaying/removing airways:

- 1) Press the **MAP** Softkey.
- 2) Press the **AIRWAYS** Softkey. Both High and Low Altitude Airways are displayed (AIRWY ON).
- 3) Press the softkey again to display Low Altitude Airways only (AIRWY LO).
- 4) Press the softkey again to display High Altitude Airways only (AIRWY HI).
- 5) Press the softkey again to remove High Altitude Airways. No airways are displayed (AIRWAYS).

Or:

- 1) Press the **MENU** Key with the Navigation Map Page displayed. The cursor flashes on the 'Map Setup' option.
- 2) Press the **ENT** Key. The Map Setup Menu is displayed.
- 3) Turn the small **FMS** Knob to select the 'Airways' group, and press the **ENT** Key.
- 4) Turn the large **FMS** Knob to highlight the 'AIRWAYS' field.
- 5) Turn the **FMS** Knob to select 'Off', 'All', 'LO Only', or 'HI Only', and press the **ENT** Key.
- 6) Press the **FMS** Knob to return to the Navigation Map Page.



Figure 5-23 Navigation Map Setup Menu - AIRWAYS Setup

The airway range is the maximum map range on which airways are displayed.

Selecting an airway range (LOW ALT AIRWAY or HI ALT AIRWAY):

- 1) Press the **MENU** Key with the Navigation Map Page displayed. The cursor flashes on the 'Map Setup' option.
- 2) Press the **ENT** Key. The Map Setup Menu is displayed.
- 3) Turn the small **FMS** Knob to select the 'Airway' group, and press the **ENT** Key.
- 4) Highlight the 'LOW ALT AIRWAY' or 'HI ALT AIRWAY' range field.
- 5) To change the range setting, turn the small **FMS** Knob to display the range list.
- 6) Select the desired range using the small **FMS** Knob.
- 7) Press the **ENT** Key.
- 8) Press the **FMS** Knob to return to the Navigation Map Page.

The following range items are configurable on the airways menu:

Airway Type	Symbol	Default Range (nm)	Maximum Range (nm)
Low Altitude Airway (LOW ALT AIRWAY)		200	500
High Altitude Airway (HI ALT AIRWAY)		300	500

Table 5-4 Airway Range Information

TRACK VECTOR

The Navigation Map can display a track vector that is useful in minimizing track angle error. The track vector is a solid light blue line segment extended to a predicted location. The track vector look-ahead time is selectable (30 sec, 60 sec (default), 2 min, 5 min, 10 min, 20 min) and determines the length of the track vector. The track vector shows up to 90 degrees of a turn for the 30 and 60 second time settings.

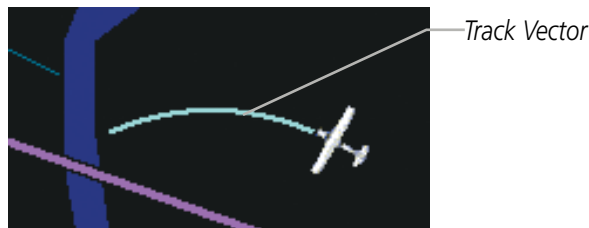

Figure 5-24 Navigation Map -Track Vector

Displaying/removing the track vector:

- 1) Press the **MENU** Key with the Navigation Map Page displayed. The cursor flashes on the 'Map Setup' option.
- 2) Press the **ENT** Key. The Map Setup Menu is displayed.
- 3) Select the 'Map' group.
- 4) Press the **ENT** Key.
- 5) Highlight the 'TRACK VECTOR' field.
- 6) Select 'On' or 'Off'. Press the **ENT** Key to accept the selected option. The flashing cursor highlights the look ahead time field. Use the **FMS** Knob to select the desired time. Press the **ENT** Key.
- 7) Press the **FMS** Knob to return to the Navigation Map Page.

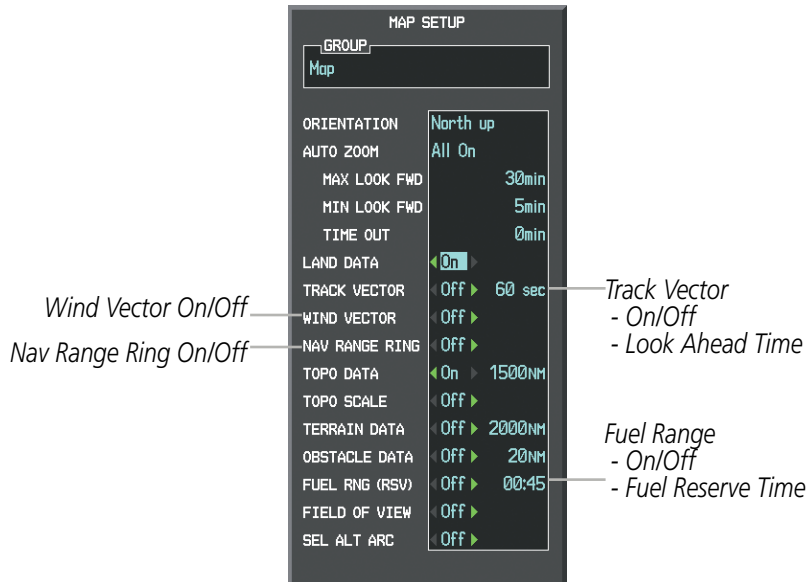

Figure 5-25 Navigation Map Setup Menu -TRACK VECTOR, WIND VECTOR, NAV RANGE RING, FUEL RANGE RING Setup

WIND VECTOR

The map displays a wind vector arrow in the upper right-hand portion of the screen. Wind vector information is displayed as a white arrow pointing in the direction in which the wind is moving for wind speeds greater than or equal to 1 kt.

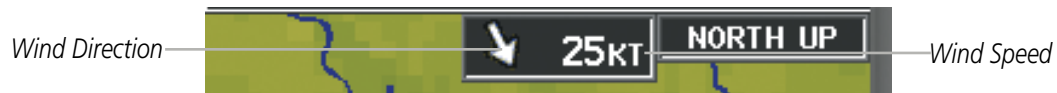

Figure 5-26 Navigation Map - Wind Vector



NOTE: The wind vector is not displayed until the aircraft is moving. It is not displayed on the Waypoint Information pages.

Displaying/removing the wind vector:

- 1) Press the **MENU** Key with the Navigation Map Page displayed. The cursor flashes on the 'Map Setup' option.
- 2) Press the **ENT** Key. The Map Setup Menu is displayed.
- 3) Select the 'Map' group.
- 4) Press the **ENT** Key.
- 5) Highlight the 'WIND VECTOR' field.
- 6) Select 'On' or 'Off'.
- 7) Press the **FMS** Knob to return to the Navigation Map Page.

NAV RANGE RING

The Nav Range Ring shows the direction of travel (ground track) on a rotating compass card. The range is determined by the map range. The range is 1/4 of the map range (e.g., 37.5 nm on a 150 nm map).

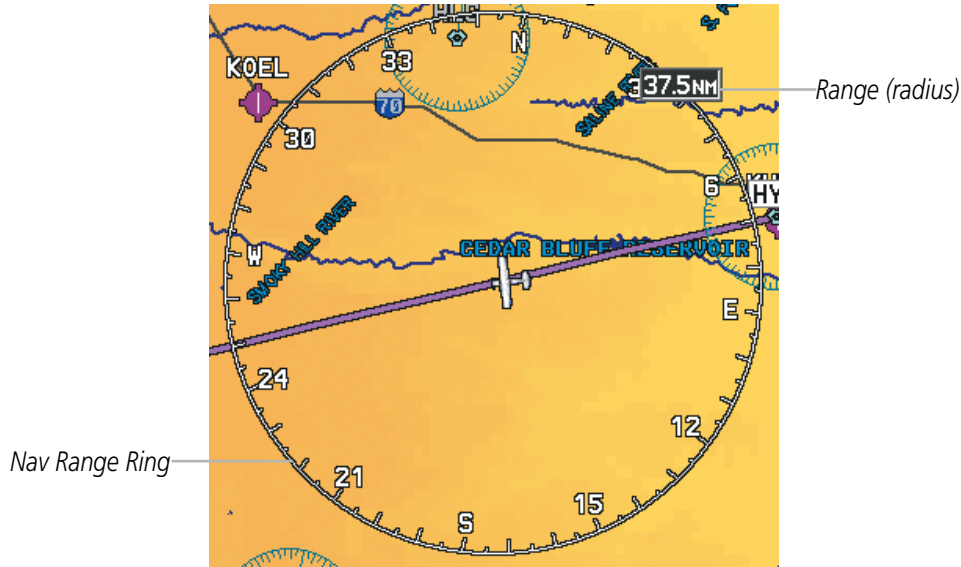

Figure 5-27 Navigation Map - Nav Range Ring



NOTE: The Nav Range Ring is not displayed on the Waypoint Information pages, Nearest pages, or Direct-to Window map.

Displaying/removing the Nav Range Ring:

- 1) Press the **MENU** Key with the Navigation Map Page displayed. The cursor flashes on the 'Map Setup' option.
- 2) Press the **ENT** Key. The Map Setup Menu is displayed.
- 3) Select the 'Map' group.
- 4) Press the **ENT** Key.
- 5) Highlight the 'NAV RANGE RING' field.
- 6) Select 'On' or 'Off'.
- 7) Press the **FMS** Knob to return to the Navigation Map Page.



NOTE: The Nav Range Ring is referenced to either magnetic or true north, based on the selection on the AUX - System Setup Page.

FUEL RANGE RING

The map can display a fuel range ring which shows the remaining flight distance. A dashed green circle indicates the selected range to reserve fuel. A solid green circle indicates the total endurance range. If only reserve fuel remains, the range is indicated by a solid yellow circle.

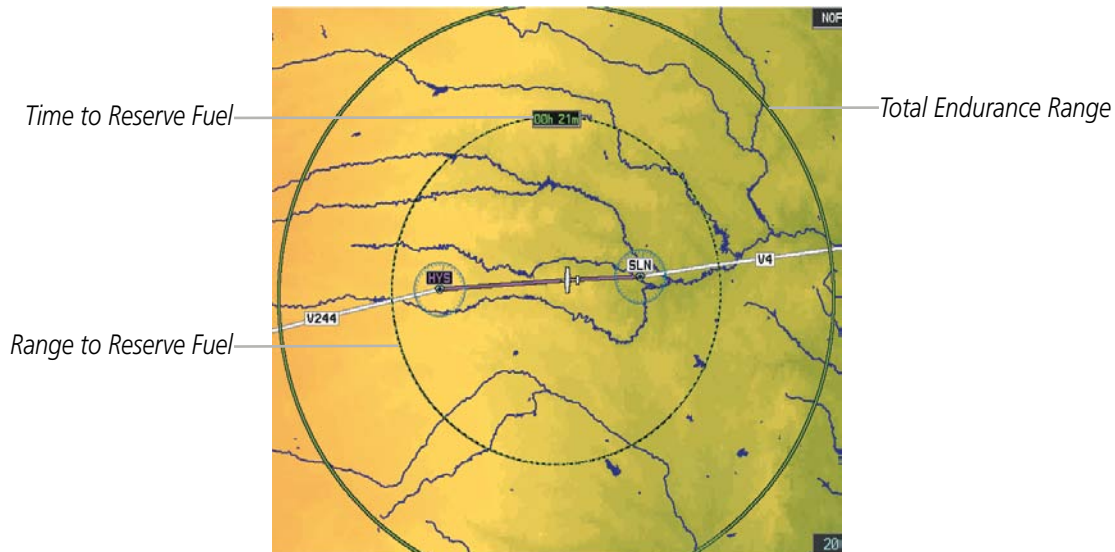

Figure 5-28 Navigation Map - Fuel Range Ring

Displaying/removing the fuel range ring and selecting a fuel range time:

- 1) Press the **MENU** Key with the Navigation Map Page displayed. The cursor flashes on the 'Map Setup' option.
- 2) Press the **ENT** Key. The Map Setup Menu is displayed.
- 3) Select the 'Map' group.
- 4) Press the **ENT** Key.
- 5) Highlight the 'FUEL RNG (RSV)' field.
- 6) Select 'On' or 'Off'.
- 7) Highlight the fuel reserve time field. This time should be set to the amount of flight time equal to the amount of fuel reserve desired.
- 8) To change the reserve fuel time, enter a time (00:00 to 23:59; hours:minutes). The default setting is 00:45 minutes.
- 9) Press the **ENT** Key.
- 10) Press the **FMS** Knob to return to the Navigation Map Page.

FIELD OF VIEW (SVS)

The map can display the boundaries of the PFD Synthetic Vision System (SVS) lateral field of view. The field of view is shown as two dashed lines forming a V shape in front of the aircraft symbol on the map. This is only available if SVS is installed on the aircraft.

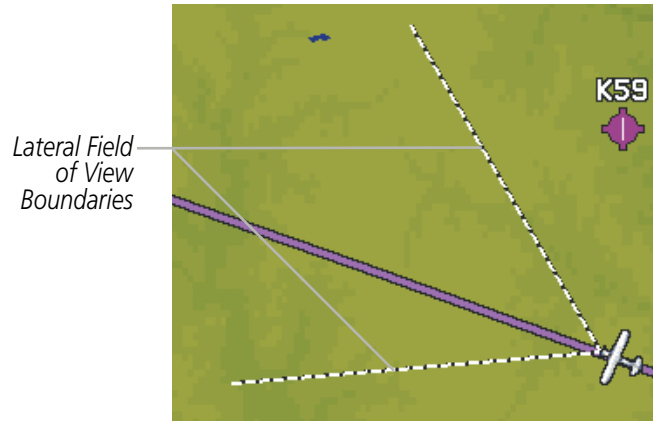

Figure 5-29 Navigation Map - Field of View

Displaying/removing the field of view:

- 1) Press the **MENU** Key with the Navigation Map Page displayed. The cursor flashes on the 'Map Setup' option.
- 2) Press the **ENT** Key. The Map Setup Menu is displayed.
- 3) Select the 'Map' group.
- 4) Press the **ENT** Key.
- 5) Highlight the 'FIELD OF VIEW' field.
- 6) Select 'On' or 'Off'.
- 7) Press the **FMS** Knob to return to the Navigation Map Page.

SELECTED ALTITUDE INTERCEPT ARC

The map can display the location along the current track where the aircraft will intercept the selected altitude. The location will be shown as a light blue arc when the aircraft is actually climbing or descending.

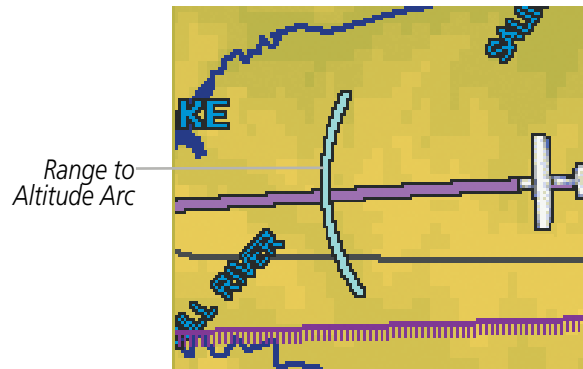

Figure 5-30 Navigation Map - Range to Altitude Arc

Displaying/removing the selected altitude intercept arc:

- 1) Press the **MENU** Key with the Navigation Map Page displayed. The cursor flashes on the 'Map Setup' option.
- 2) Press the **ENT** Key. The Map Setup Menu is displayed.
- 3) Select the 'Map' group.
- 4) Press the **ENT** Key.
- 5) Highlight the 'SEL ALT ARC' field.
- 6) Select 'On' or 'Off'.
- 7) Press the FMS Knob to return to the Navigation Map Page.

5.3 WAYPOINTS

Waypoints are predetermined geographical positions (internal database) or pilot-entered positions, and are used for all phases of flight planning and navigation.

Communication and navigation frequencies can be tuned “automatically” from various Waypoint Information (WPT) pages, Nearest (NRST) pages, and the Nearest Airports Window (on PFD). This auto-tuning feature simplifies frequency entry over manual tuning. Refer to the Audio Panel and CNS section for details on auto-tuning.

Waypoints can be selected by entering the ICAO identifier, entering the name of the facility, or by entering the city name. See the System Overview section for detailed instructions on entering data in the G1000. As a waypoint identifier, facility name, or location is entered, the G1000’s Spell’N’Find™ feature scrolls through the database, displaying those waypoints matching the characters which have been entered to that point. A direct-to navigation leg to the selected waypoint can be initiated by pressing the **Direct-to** Key on any of the waypoint pages.



Figure 5-31 Waypoint Information Window

If duplicate entries exist for the entered facility name or location, additional entries may be viewed by continuing to turn the small **FMS** Knob during the selection process. If duplicate entries exist for an identifier, a Duplicate Waypoints Window is displayed when the **ENT** Key is pressed.

- SYSTEM OVERVIEW
- FLIGHT INSTRUMENTS
- EIS
- AUDIO PANEL & CNS
- FLIGHT MANAGEMENT
- HAZARD AVOIDANCE
- AFCS
- ADDITIONAL FEATURES
- APPENDICES
- INDEX



Figure 5-32 Waypoint Information Window - Duplicate Identifier

AIRPORTS



NOTE: 'North Up' orientation on the Airport Information Page cannot be changed; the pilot needs to be aware of proper orientation if the Navigation Map orientation is different from the Airport Information Page Map.

The Airport Information Page is the first page in WPT group and allows the pilot to view airport information, load frequencies (COM, NAV, and lighting), review runways, and review instrument procedures that may be involved in the flight plan. See the Audio Panel and CNS Section for more information on loading frequencies (auto-tuning). After engine startup, the Airport Information Page defaults to the airport where the aircraft is located. After a flight plan has been loaded, it defaults to the destination airport. On a flight plan with multiple airports, it defaults to the airport which is the current active waypoint.

In addition to displaying a map of the currently selected airport and surrounding area, the Airport Information Page displays airport information in three boxes labeled 'AIRPORT', 'RUNWAYS', and 'FREQUENCIES'. For airports with multiple runways, information for each runway is available. This information is viewed on the Airport Information Page by pressing the INFO softkey until **INFO-1** is displayed.

- SYSTEM OVERVIEW
- FLIGHT INSTRUMENTS
- EIS
- AUDIO PANEL & CNS
- FLIGHT MANAGEMENT
- HAZARD AVOIDANCE
- AFCS
- ADDITIONAL FEATURES
- APPENDICES
- INDEX

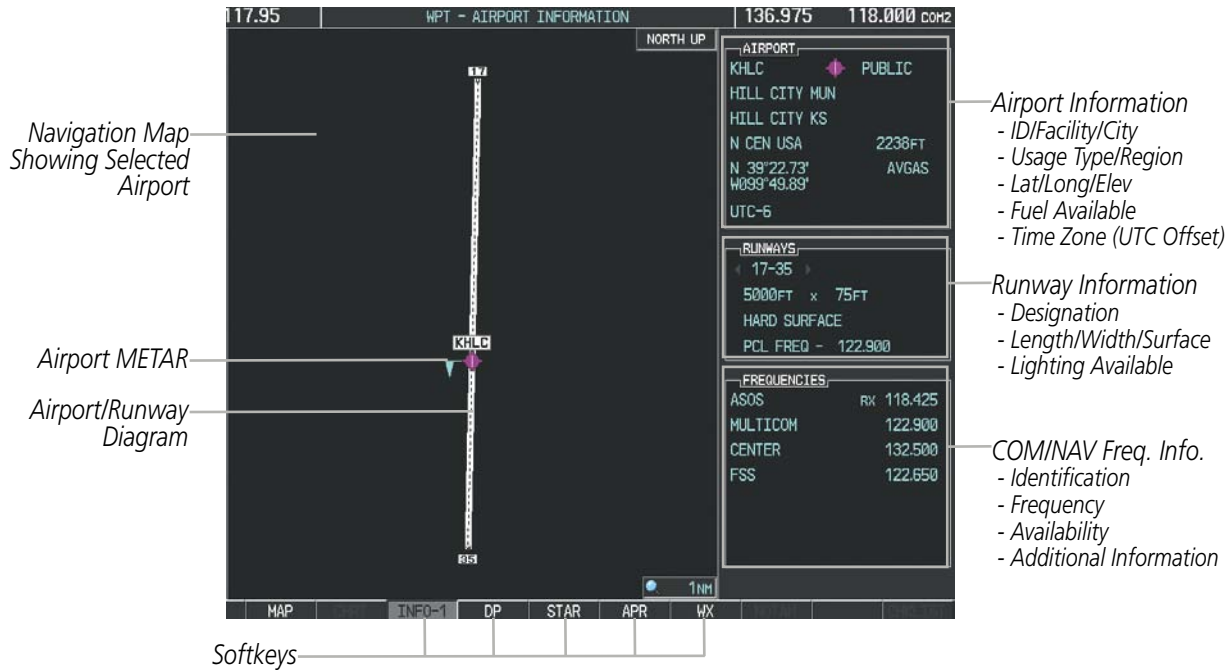

Figure 5-33 Airport Information Page

The following descriptions and abbreviations are used on the Airport Information Page:

- Usage type: Public, Military, Private, or Helicopter
- Runway surface type: Hard, Turf, Sealed, Gravel, Dirt, Soft, Unknown, or Water
- Runway lighting type: No Lights, Part Time, Full Time, Unknown, or PCL Freq (for pilot-controlled lighting)
- COM Availability: TX (transmit only), RX (receive only), PT (part time), i (additional information available)

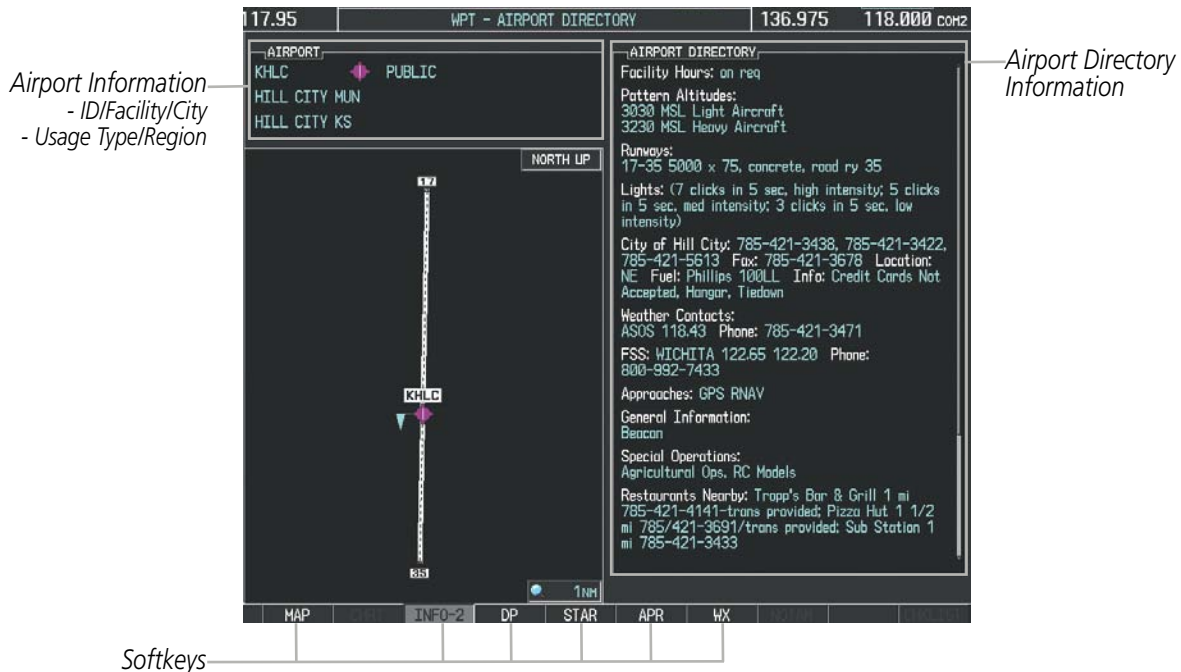

Figure 5-34 Airport Directory Page Example

The AOPA directory information is viewed on the Airport Directory Page by pressing the INFO softkey until **INFO-2** is displayed. The following are types of AOPA airport directory information shown (if available) on the Airport Directory Page:

- **Airport:** Identifier, Site Number, Name, City, State
- **Phones:** Phone/Fax Numbers
- **Hours:** Facility Hours, Light Hours, Tower Hours, Beacon Hours
- **Location:** Sectional, Magnetic Variation
- **Frequencies:** Type/Frequency
- **Transportation:** Ground Transportation Type Available
- **Approach:** Approach Facility Name, Frequency, Frequency Parameter
- **Traffic Pattern Altitudes (TPA):** Aircraft Class/Altitude
- **Weather:** Service Type, Frequency, Phone Number
- **Flight Service Station (FSS):** FSS Name, Phone Numbers
- **Instrument Approaches:** Published Approach, Frequency
- **NAVAIDS:** Type, Identifier, Frequency, Radial, Distance
- **Noise:** Noise Abatement Procedures
- **Charts:** Low Altitude Chart Number
- **Runway:** Headings, Length, Width, Obstructions, Surface
- **Obstructions:** General Airport Obstructions
- **Special Operations at Airport**
- **Services Available:** Category, Specific Service
- **Notes:** Airport Notes
- **Pilot Controlled Lighting:** High/Med/Low Clicks/Second
- **FBO:** Type, Frequencies, Services, Fees, Fuel, Credit Cards, Phone/Fax Numbers

Selecting an airport for review by identifier, facility name, or location:

- 1) From the Airport Information Page, press the **FMS** Knob.
- 2) Use the **FMS** Knobs and enter an identifier, facility name, or location.
- 3) Press the **ENT** Key.
- 4) Press the **FMS** Knob to remove the cursor.

Selecting a runway:

- 1) With the Airport Information Page displayed, press the **FMS** Knob to activate the cursor.
- 2) Turn the large **FMS** Knob to place the cursor in the 'RUNWAYS' Box, on the runway designator.
- 3) Turn the small **FMS** Knob to display the desired runway (if more than one) for the selected airport.
- 4) To remove the flashing cursor, press the **FMS** Knob.

View a destination airport:

From the Airport Information Page press the **MENU** Key. Select 'View Destination Airport'. The Destination Airport is displayed.

The Airport Frequencies Box uses the descriptions and abbreviations listed in the following table:

Communication Frequencies			Navigation Frequencies
Approach *	Control	Pre-Taxi	ILS
Arrival *	CTA *	Radar	LOC
ASOS	Departure *	Ramp	
ATIS	Gate	Terminal *	
AWOS	Ground	TMA *	
Center	Helicopter	Tower	
Class B *	Multicom	TRSA *	
Class C *	Other	Unicom	
Clearance			
* May include Additional Information			

Table 5-5 Airport Frequency Abbreviations

A departure, arrival, or approach can be loaded using the softkeys on the Airport Information Page. See the Procedures section for details. METARs or TAFs applicable to the selected airport can be selected for display (see the Hazard Avoidance section for details about weather).

The G1000 provides a **NRST** Softkey on the PFD, which gives the pilot quick access to nearest airport information (very useful if an immediate landing is required). The Nearest Airports Window displays a list of the 25 nearest airports (three entries can be displayed at one time). If there are more than three they are displayed in a scrollable list. If there are no nearest airports available, “NONE WITHIN 200NM” is displayed.



Figure 5-35 Nearest Airports Window on PFD

Pressing the **ENT** Key displays the PFD Airport Information Window for the highlighted airport. Pressing the **ENT** Key again returns to the Nearest Airports Window with the cursor on the next airport in the list. Continued presses of the **ENT** Key sequences through the information pages for all airports in the Nearest Airports list.

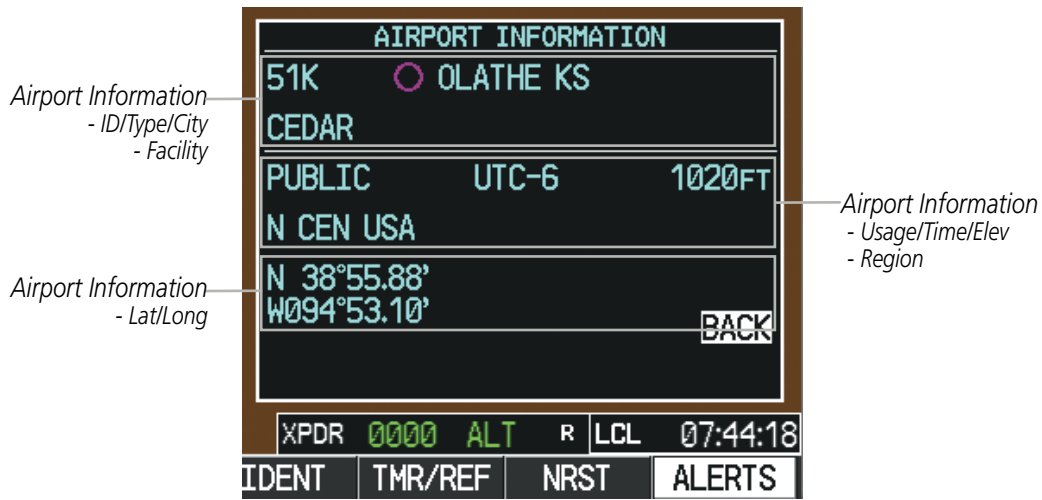

Figure 5-36 Airport Information Window on PFD

The Nearest Airports Page on the MFD is first in the group of NRST pages because of its potential use in the event of an in-flight emergency. In addition to displaying a map of the currently selected airport and surrounding area, the page displays nearest airport information in five boxes labeled 'NEAREST AIRPORTS', 'INFORMATION', 'RUNWAYS', 'FREQUENCIES', and 'APPROACHES'.

The selected airport is indicated by a white arrow, and a dashed white line is drawn on the navigation map from the aircraft position to the nearest airport. Up to five nearest airports, one runway, up to three frequencies, and up to three approaches are visible at one time. If there are more than can be shown, each list can be scrolled. If there are no items for display in a boxed area, text indicating that fact is displayed. The currently selected airport remains in the list until it is unselected.

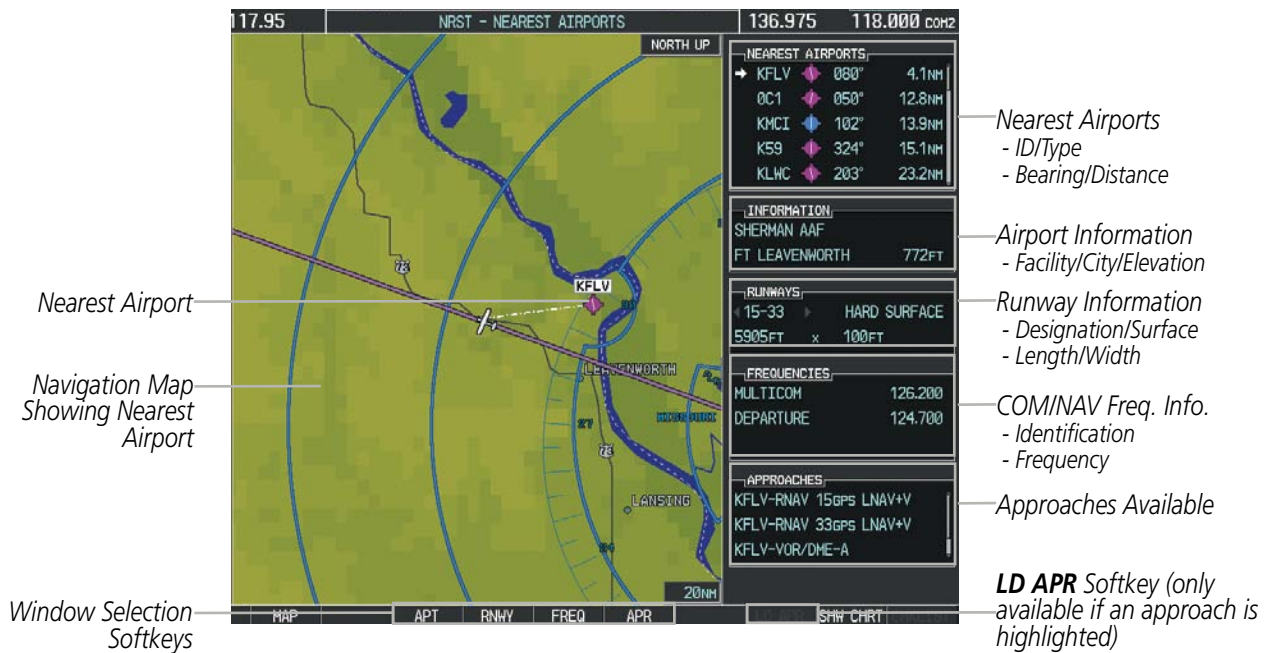

Figure 5-37 Nearest Airport Page

Viewing information for a nearest airport on the PFD:

- 1) Press the **NRST** Softkey to display the Nearest Airports Window. Press the **FMS** Knob to activate the cursor.
- 2) Highlight the airport identifier with the **FMS** Knob and press the **ENT** Key to display the Airport Information Window.
- 3) To return to the Nearest Airports Window press the **ENT** Key (with the cursor on 'BACK') or press the **CLR** Key. The cursor is now on the next airport in the nearest airports list. (Repeatedly pressing the **ENT** Key moves through the airport list, alternating between the Nearest Airports Window and the Airport Information Window.)
- 4) Press the **CLR** Key or the **NRST** Key to close the PFD Nearest Airports Window.

Viewing information for a nearest airport on the MFD:

- 1) Turn the large **FMS** Knob to select the NRST page group.
- 2) Turn the small **FMS** Knob to select the Nearest Airports Page (it is the first page of the group, so it may already be selected). If there are no Nearest Airports available, "NONE WITHIN 200 NM" is displayed.
- 3) Press the **APT** Softkey; or press the **FMS** Knob; or press the **MENU** Key, highlight 'Select Airport Window' and press the **ENT** Key. The cursor is placed in the 'NEAREST AIRPORTS' Box. The first airport in the nearest airports list is highlighted.
- 4) Turn the **FMS** Knob to highlight the desired airport. (Pressing the **ENT** Key also moves to the next airport.)
- 5) Press the **FMS** Knob to remove the flashing cursor.

Viewing runway information for a specific airport:

- 1) With the Nearest Airports Page displayed, press the **RNWX** Softkey; or press the **MENU** Key, highlight 'Select Runway Window'; and press the **ENT** Key. The cursor is placed in the 'RUNWAYS' Box.
- 2) Turn the small **FMS** Knob to select the desired runway.
- 3) Press the **FMS** Knob to remove the flashing cursor.

See the Audio Panel and CNS Section for frequency selection and the Procedures section for approaches.

The Nearest Airports Box on the System Setup Page defines the minimum runway length and surface type used when determining the 25 nearest airports to display on the MFD Nearest Airports Page. A minimum runway length and/or surface type can be entered to prevent airports with small runways or runways that are not appropriately surfaced from being displayed. Default settings are 0 feet (or meters) for runway length and "HARD/SOFT" for runway surface type.

Selecting nearest airport surface matching criteria:

- 1) Use the **FMS** Knob to select the System Setup Page.
- 2) Press the **FMS** Knob momentarily to activate the flashing cursor.
- 3) Turn the large **FMS** Knob to highlight the runway surface field in the Nearest Airports Box.
- 4) Turn the small **FMS** Knob to select the desired runway option (ANY, HARD ONLY, HARD/SOFT, WATER).
- 5) Press the **ENT** Key.
- 6) Press the **FMS** Knob to remove the flashing cursor.

Selecting nearest airport minimum runway length matching criteria:

- 1) Use the **FMS** Knob to select the System Setup Page.
- 2) Press the **FMS** Knob momentarily to activate the flashing cursor.
- 3) Turn the large **FMS** Knob to highlight the minimum length field in the Nearest Airport Box.
- 4) Use the **FMS** Knob to enter the minimum runway length (zero to 25,000 feet) and press the **ENT** Key.
- 6) Press the **FMS** Knob to remove the flashing cursor.

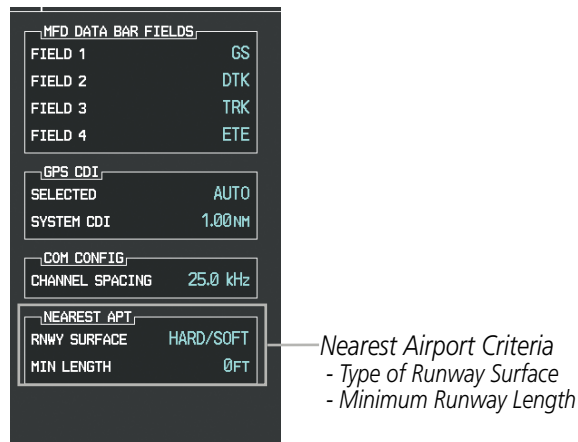

Figure 5-38 System Setup Page - Nearest Airport Selection Criteria

INTERSECTIONS



NOTE: The VOR displayed on the Intersection Information Page is the nearest VOR, not necessarily the VOR used to define the intersection.

The Intersection Information Page is used to view information about intersections. In addition to displaying a map of the currently selected intersection and surrounding area, the Intersection Information Page displays intersection information in three boxes labeled ‘INTERSECTION’, ‘INFORMATION’, and ‘NEAREST VOR’.

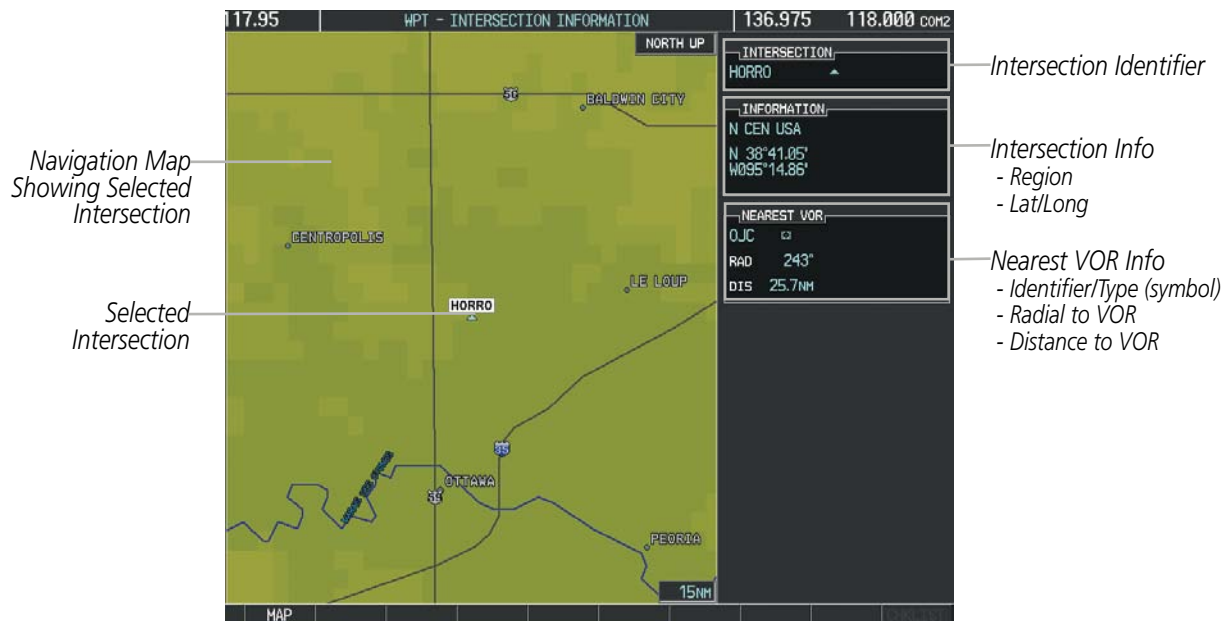

Figure 5-39 Intersection Information Page

Selecting an intersection:

- 1) With the Intersection Information Page displayed, enter an identifier in the Intersection Box.
- 2) Press the **ENT** Key.
- 3) Press the **FMS** Knob to remove the flashing cursor.

Or:

- 1) With the Nearest Intersections Page displayed, press the **FMS** Knob.
- 2) Press the **ENT** Key or turn either **FMS** Knob to select an identifier in the Nearest Intersection Box.
- 3) Press the **FMS** Knob to remove the flashing cursor.

The Nearest Intersections Page can be used to quickly find an intersection close to the flight path. In addition to displaying a map of the surrounding area, the page displays information for up to 25 nearest intersections in three boxes labeled 'NEAREST INT', 'INFORMATION', and 'REFERENCE VOR'.

The selected intersection is indicated by a white arrow. Up to eleven Intersections are visible at a time. If there are more than can be shown, the list can be scrolled. If there are no items for display, text indicating that fact is displayed.



NOTE: The list only includes waypoints that are within 200 nm.



Figure 5-40 Nearest Intersections Page

NDBs

The NDB Information Page is used to view information about NDBs. In addition to displaying a map of the currently selected NDB and surrounding area, the page displays NDB information in four boxes labeled 'NDB', 'INFORMATION', 'FREQUENCY', and 'NEAREST AIRPORT'.



Figure 5-41 NDB Information Page



NOTE: Compass locator (LOM, LMM): a low power, low or medium frequency radio beacon installed in conjunction with the instrument landing system. When LOM is used, the locator is at the Outer Marker; when LMM is used, the locator is at the Middle Marker.

Selecting an NDB:

- 1) With the NDB Information Page displayed, enter an identifier, the name of the NDB, or the city in which it's located in the NDB Box.
 - 2) Press the **ENT** Key.
 - 3) Press the **FMS** Knob to remove the flashing cursor.
- Or:**
- 1) With the Nearest NDB Page displayed, press the **FMS** Knob.
 - 2) Press the **ENT** Key or turn either **FMS** Knob to select an identifier in the Nearest NDB Box.
 - 3) Press the **FMS** Knob to remove the flashing cursor.

The Nearest NDB Page can be used to quickly find a NDB close to the flight path. In addition to displaying a map of the surrounding area, the page displays information for up to 25 nearest NDBs in three boxes labeled 'NEAREST NDB', 'INFORMATION', and 'FREQUENCY'.

A white arrow before the NDB identifier indicates the selected NDB. Up to eleven NDBs are visible at a time. If there are more than can be shown, each list can be scrolled. The list only includes waypoints that are within 200nm. If there are no NDBs in the list, text indicating that there are no nearest NDBs is displayed. If there are no nearest NDBs in the list, the information and frequency fields are dashed.



Figure 5-42 Nearest NDB Page

VORs

The VOR Information Page can be used to view information about VOR and ILS signals (since ILS signals can be received on a NAV receiver), or to quickly auto-tune a VOR or ILS frequency. Localizer information cannot be viewed on the VOR Information Page. If a VOR station is combined with a TACAN station it is listed as a VORTAC on the VOR Information Page and if it includes only DME, it is displayed as VOR-DME.

In addition to displaying a map of the currently selected VOR and surrounding area, the VOR Information Page displays VOR information in four boxes labeled 'VOR', 'INFORMATION', 'FREQUENCY', and 'NEAREST AIRPORT'.

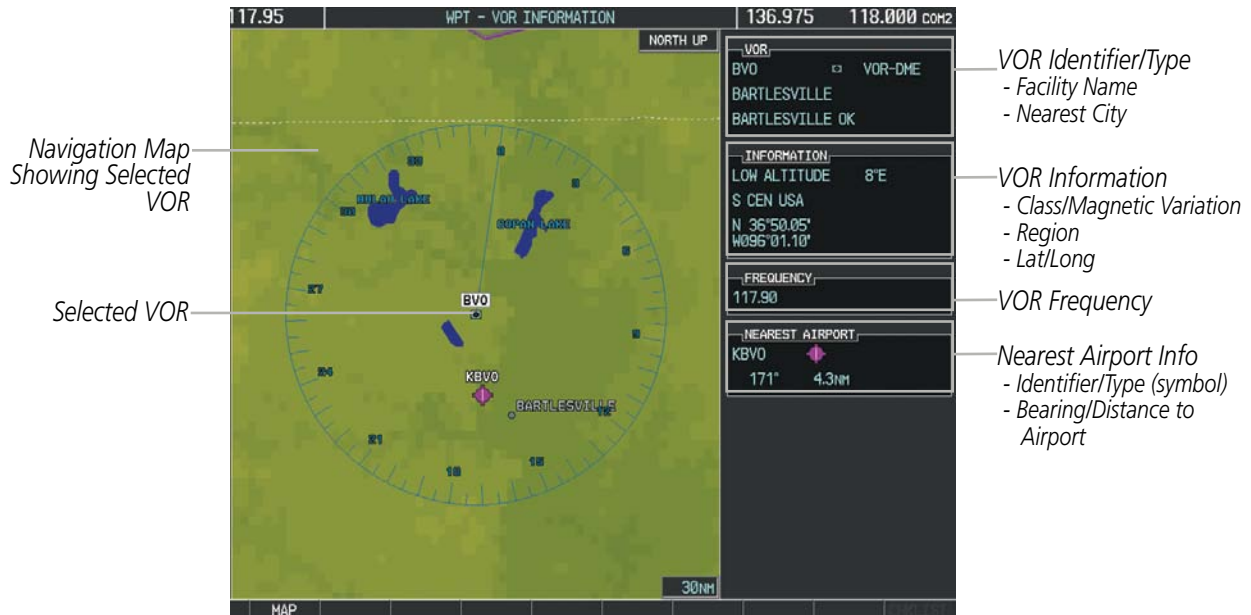

Figure 5-43 VOR Information Page

The VOR classes used in the VOR information box are: LOW ALTITUDE, HIGH ALTITUDE, and TERMINAL.

Select a VOR:

- 1) With the VOR Information Page displayed, enter an identifier, the name of the VOR, or the city in which it's located in the VOR Box.
- 2) Press the **ENT** Key.
- 3) Press the **FMS** Knob to remove the flashing cursor.

Or:

- 1) With the Nearest VOR Page displayed, press the **FMS** Knob or press the **VOR** Softkey.
- 2) Press the **ENT** Key or turn either **FMS** Knob to select an identifier in the Nearest VOR Box.
- 3) Press the **FMS** Knob to remove the flashing cursor.

Or:

- 1) With the Nearest VOR Page displayed, press the **MENU** Key.
- 2) Highlight 'Select VOR Window', and press the **ENT** Key.
- 3) Press the **ENT** Key or turn either **FMS** Knob to select an identifier in the Nearest VOR Box.
- 4) Press the **FMS** Knob to remove the flashing cursor.

The Nearest VOR Page can be used to quickly find a VOR station close to the aircraft. Also, a NAV frequency from a selected VOR station can be loaded from the Nearest VOR Page. In addition to displaying a map of the surrounding area, the Nearest VOR Page displays information for up to 25 nearest VOR stations in three boxes labeled 'NEAREST VOR', 'INFORMATION', and 'FREQUENCY'. The list only includes waypoints that are within 200 nm.

A white arrow before the VOR identifier indicates the selected VOR. Up to eleven VORs are visible at a time. If there are more than can be shown, each list can be scrolled. If there are no VORs in the list, text indicating that there are no nearest VORs is displayed. If there are no nearest VORs in the list, the information is dashed.

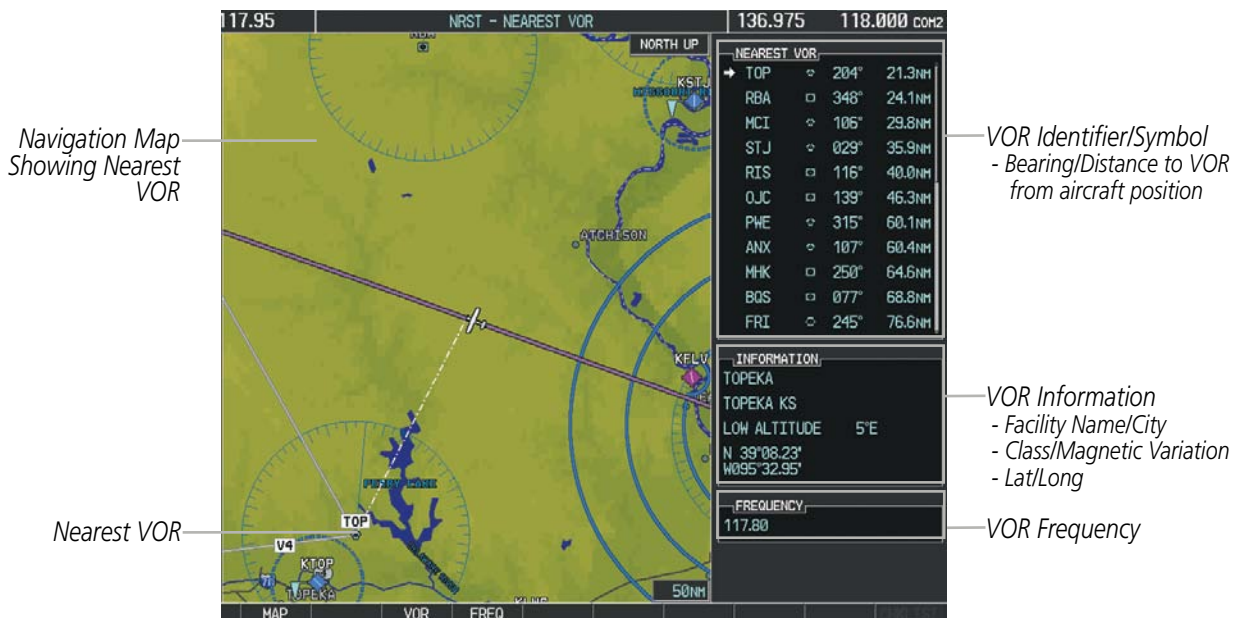

Figure 5-44 Nearest VOR Page

USER WAYPOINTS

The G1000 can create and store up to 1,000 user-defined waypoints. User waypoints can be created from any map page (except PFD Inset Map, AUX-Trip Planning Page, or Procedure Pages) by selecting a position on the map using the **Joystick**, or from the User Waypoint Information Page by referencing a bearing/distance from an existing waypoint, bearings from two existing waypoints, or latitude and longitude. Once a waypoint has been created, it can be renamed, deleted, or moved. Temporary user waypoints are erased upon system power down.



Figure 5-45 User Waypoint Information Page

Selecting a User Waypoint:

- 1) With the User Waypoint Information Page displayed, enter the name of the User Waypoint, or scroll to the desired waypoint in the User Waypoint List using the large **FMS** Knob.
 - 2) Press the **ENT** Key.
 - 3) Press the **FMS** Knob to remove the flashing cursor.
- Or:**
- 1) With the Nearest User Waypoints Page displayed, press the **FMS** Knob.
 - 2) Press the **ENT** Key or turn either **FMS** Knob to select an identifier in the Nearest USR Box.
 - 3) Press the **FMS** Knob to remove the flashing cursor.



Figure 5-46 Nearest User Waypoint Page

CREATING USER WAYPOINTS

User waypoints can be created from the User Waypoint Information Page in the following ways:

Creating user waypoints from the User Waypoint Information Page:

- 1) Select the **NEW** Softkey, or press the **MENU** Key and select 'Create New User Waypoint'.
- 2) Enter a user waypoint name (up to six characters).
- 3) Press the **ENT** Key. The current aircraft position is the default location of the new waypoint.
- 4) If desired, define the type and location of the waypoint in one of the following ways:
 - a) Select "RAD/RAD" using the small **FMS** Knob, press the **ENT** Key, and enter the two reference waypoint identifiers and radials into the REFERENCE WAYPOINTS window using the **FMS** Knobs.
 - Or:
 - b) Select "RAD/DIS" using the small **FMS** Knob, press the **ENT** Key, and enter the reference waypoint identifier, the radial, and the distance into the REFERENCE WAYPOINTS window using the **FMS** Knobs.
 - Or:
 - c) Select "LAT/LON" using the small **FMS** Knob, press the **ENT** Key, and enter the latitude and longitude into the INFORMATION window using the **FMS** Knobs.
- 5) Press the **ENT** Key to accept the new waypoint.
- 6) If desired, change the storage method of the waypoint to "TEMPORARY" or "NORMAL" by moving the cursor to "TEMPORARY" and selecting the **ENT** Key to check or uncheck the box.
- 7) Press the **FMS** Knob to remove the flashing cursor.
- Or:

- 1) Press the **FMS** Knob to activate the cursor.
- 2) Enter a user waypoint name (up to six characters).
- 3) Press the **ENT** Key. The message 'Are you sure you want to create the new User Waypoint AAAAAA?' is displayed.
- 4) With 'YES' highlighted, press the **ENT** Key.
- 5) If desired, define the type and location of the waypoint in one of the following ways:
 - a) Select "RAD/RAD" using the small **FMS** Knob, press the **ENT** Key, and enter the two reference waypoint identifiers and radials into the REFERENCE WAYPOINTS window using the **FMS** Knobs.
 - Or:
 - b) Select "RAD/DIS" using the small **FMS** Knob, press the **ENT** Key, and enter the reference waypoint identifier, the radial, and the distance into the REFERENCE WAYPOINTS window using the **FMS** Knobs.
 - Or:
 - c) Select "LAT/LON" using the small **FMS** Knob, press the **ENT** Key, and enter the latitude and longitude into the INFORMATION window using the **FMS** Knobs.
- 6) Press the **ENT** Key to accept the new waypoint.
- 7) If desired, change the storage method of the waypoint to "TEMPORARY" or "NORMAL" by moving the cursor to "TEMPORARY" and selecting the **ENT** Key to check or uncheck the box.
- 8) Press the **FMS** Knob to remove the flashing cursor.



Figure 5-47 User Waypoint Information Page Menu

Creating user waypoints from map pages:

- 1) Press the **Joystick** to activate the panning function and pan to the map location of the desired user waypoint.
- 2) Press the **ENT** Key. The User Waypoint Information Page is displayed with the captured position.



NOTE: If the pointer has highlighted a map database feature, one of three things happens upon pressing the **ENT** Key: 1) information about the selected feature is displayed instead of initiating a new waypoint, 2) a menu pops up allowing a choice between 'Review Airspaces' or 'Create User Waypoint', or 3) a new waypoint is initiated with the default name being the selected map item.

- 3) Enter a user waypoint name (up to six characters).
- 4) Press the **ENT** Key to accept the selected name. The first reference waypoint box is highlighted.
- 5) If desired, define the type and location of the waypoint in one of the following ways:
 - a) Select "RAD/RAD" using the small **FMS** Knob, press the **ENT** Key, and enter the two reference waypoint identifiers and radials into the REFERENCE WAYPOINTS window using the **FMS** Knobs.
Or:
 - b) Select "RAD/DIS" using the small **FMS** Knob, press the **ENT** Key, and enter the reference waypoint identifier, the radial, and the distance into the REFERENCE WAYPOINTS window using the **FMS** Knobs.
Or:
 - c) Select "LAT/LON" using the small **FMS** Knob, press the **ENT** Key, and enter the latitude and longitude into the INFORMATION window using the **FMS** Knobs.
- 6) Press the **ENT** Key to accept the new waypoint.
- 7) If desired, change the storage method of the waypoint to "TEMPORARY" or "NORMAL" by moving the cursor to "TEMPORARY" and selecting the **ENT** Key to check or uncheck the box.
- 8) Press the **FMS** Knob to remove the flashing cursor.
- 9) Press the **GO BACK** Softkey to return to the map page.

EDITING USER WAYPOINTS

Editing a user waypoint comment or location:

- 1) With the User Waypoint Information Page displayed, press the **FMS** Knob to activate the cursor.
- 2) Select a user waypoint in the User Waypoint List, if required, and press the **ENT** Key.
- 3) Move the cursor to the desired field.
- 4) Turn the small **FMS** Knob to make any changes.
- 5) Press the **ENT** Key to accept the changes.
- 6) Press the **FMS** Knob to remove the flashing cursor.

Renaming user waypoints:

- 1) Highlight a user waypoint in the User Waypoint List. Press the **RENAME** Softkey, or press the **MENU** Key and select 'Rename User Waypoint'.
- 2) Enter a new name.
- 3) Press the **ENT** Key. The message 'Do you want to rename the user waypoint AAAAAA toBBBBBB?' is displayed.
- 4) With 'YES' highlighted, press the **ENT** Key.
- 5) Press the **FMS** Knob to remove the flashing cursor.

Changing the location of an existing waypoint to the aircraft present position:

- 1) Enter a waypoint name or select the waypoint in the User Waypoint List, then press the **ENT** Key.
- 2) Press the **MENU** Key.
- 3) Select 'Use Present Position'.
- 4) Press the **ENT** Key twice. The new waypoint's location is saved.
- 5) Press the **FMS** Knob to remove the flashing cursor.

A system generated comment for a user waypoint incorporates the reference waypoint identifier, bearing, and distance. If a system generated comment has been edited, a new comment can be generated.

Resetting the comment field to the system generated comment:

- 1) Enter a waypoint name or select the waypoint in the User Waypoint List, then press the **ENT** Key.
- 2) Press the **MENU** Key.
- 3) Select 'Auto Comment'.
- 4) Press the **ENT** Key. The generated comment is based on the reference point used to define the waypoint.

The default type of user waypoint (normal or temporary) can be changed using the user waypoint information page menu. Temporary user waypoints are automatically deleted upon the next power cycle.

Changing the user waypoint storage duration default setting:

- 1) With the User Waypoint Information Page displayed, press the **MENU** Key.
- 2) Move the cursor to select 'Waypoint Setup', and press the **ENT** Key.
- 3) Select 'NORMAL' or 'TEMPORARY' as desired, and press the **ENT** Key.
- 4) Press the **FMS** Knob to remove the flashing cursor and return to the User Waypoint Information Page.

DELETING USER WAYPOINTS

Deleting a single user waypoint:

- 1) Highlight a User Waypoint in the User Waypoint List, or enter a waypoint in the User Waypoint field.
- 2) Press the **DELETE** Softkey or press the **CLR** Key. 'Yes' is highlighted in the confirmation window.
- 3) Press the **ENT** Key.
- 4) Press the **FMS** Knob to remove the flashing cursor.

Or:

- 1) Highlight a User Waypoint in the User Waypoint List, or enter a waypoint in the User Waypoint field.
- 2) Press the **MENU** Key.
- 3) Select 'Delete User Waypoint'.
- 4) Press the **ENT** Key twice to confirm the selection.
- 5) Press the **FMS** Knob to remove the flashing cursor.



NOTE: The option to 'Delete All User Waypoints' is not available while the aircraft is in flight.

Deleting all user waypoints:

- 1) Highlight a User Waypoint in the User Waypoint List.
- 2) Press the **MENU** Key.
- 3) Select 'Delete All User Waypoints'.
- 4) Press the **ENT** Key twice to confirm the selection.
- 5) Press the **FMS** Knob to remove the flashing cursor.

5.4 AIRSPACES

The G1000 can display the following types of airspaces: Class B/TMA, Class C/TCA, Class D, Restricted, MOA (Military), Other Airspace, Air Defense Interdiction Zone (ADIZ), and Temporary Flight Restriction (TFR).



Figure 5-48 Airspaces

The Nearest Airspaces Page, Airspace Alerts Window, and Airspace Alerts on the PFD provide additional information about airspaces and the location of the aircraft in relationship to them.

The Airspace Alerts Box allows the pilot to turn the controlled/special-use airspace message alerts on or off. This does not affect the alerts listed on the Nearest Airspaces Page or the airspace boundaries depicted on the Navigation Map Page. It simply turns on/off the warning provided when the aircraft is approaching or near an airspace.

An altitude buffer is also provided which “expands” the vertical range above or below an airspace. For example, if the buffer is set at 500 feet, and the aircraft is more than 500 feet above/below an airspace, an alert message is not generated, but if the aircraft is less than 500 feet above/below an airspace and projected to enter it, the pilot is notified with an alert message. The default setting for the altitude buffer is 200 feet.

Changing the altitude buffer distance setting:

- 1) Use the **FMS** Knob to select the AUX - System Setup Page.
- 2) Press the **FMS** Knob momentarily to activate the flashing cursor.
- 3) Turn the large **FMS** Knob to highlight the altitude buffer field in the Airspace Alerts Box.
- 4) Use the **FMS** Knob to enter an altitude buffer value and press the **ENT** Key.
- 5) Press the **FMS** Knob to remove the flashing cursor.

Turning an airspace alert on or off:

- 1) Use the **FMS** Knob to select the AUX - System Setup Page.
- 2) Press the **FMS** Knob momentarily to activate the flashing cursor.
- 3) Turn the large **FMS** Knob to highlight the desired field in the Airspace Alerts Box.
- 4) Turn the small **FMS** Knob clockwise to turn the airspace alert ON or counterclockwise to turn the alert OFF.
- 5) Press the **FMS** Knob to remove the flashing cursor.



Figure 5-49 System Setup Page - Airspace Alerts

Map ranges for the airspace boundaries are selected from the Aviation Group in the Map Setup Menu. See Table 5-2 for the default and maximum ranges for each type of airspace and the symbol defining the airspace area.

The Nearest Airspaces Page can be used to quickly find airspaces close to the flight path. In addition, a selected frequency associated with the airspace can be loaded from the Nearest Airspaces Page. In addition to displaying a map of airspace boundaries and surrounding area, the Nearest Airspaces Page displays airspace information in four boxes labeled ‘AIRSPACE ALERTS’, ‘AIRSPACE, AGENCY’, ‘VERTICAL LIMITS’, and ‘FREQUENCIES’.

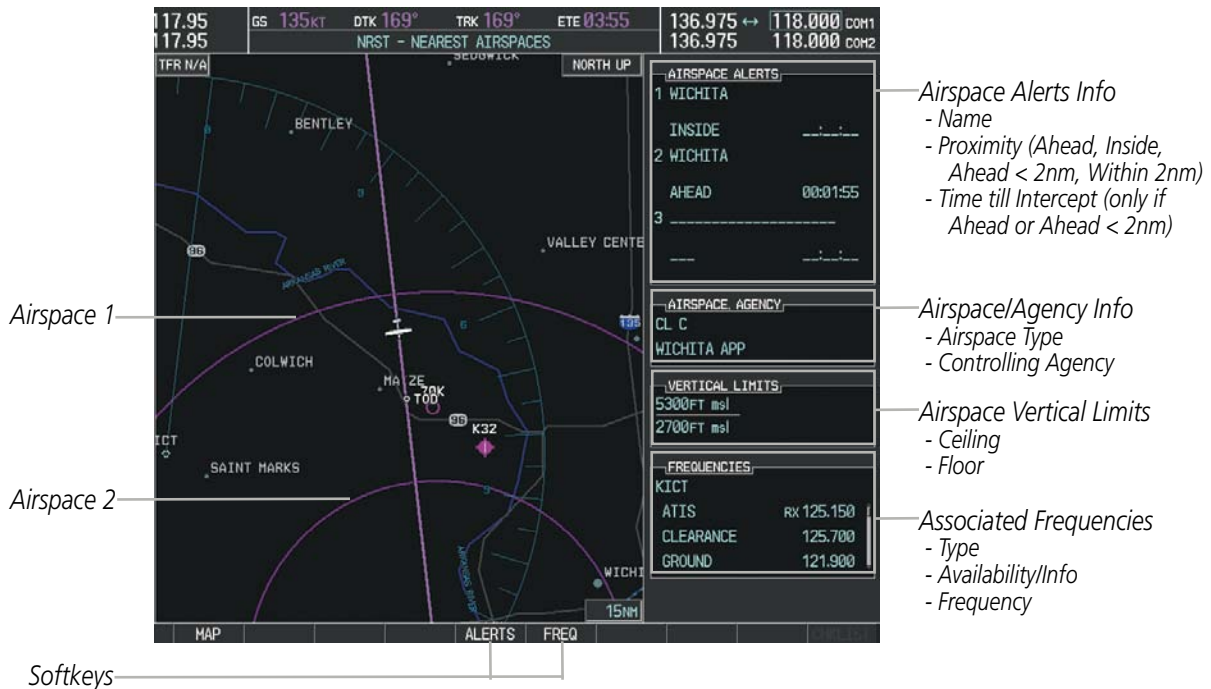

Figure 5-50 Nearest Airspaces Page

Airspace alerts and associated frequencies are shown in scrollable lists on the Nearest Airspaces Page. The **ALERTS** and **FREQ** softkeys place the cursor in the respective list. The **FREQ** Softkey is enabled only if one or more frequencies exist for a selected airspace.

Selecting and viewing an airspace alert with its associated information:

- 1) Select the Nearest Airspaces Page.
- 2) Press the **ALERTS** Softkey; or press the **FMS** Knob; or press the **MENU** Key, highlight 'Select Alerts Window', and press the **ENT** Key. The cursor is placed in the 'AIRSPACE ALERTS' Box.
- 3) Select the desired airspace.
- 4) Press the **FMS** Knob to remove the flashing cursor.

Pressing the PFD **ALERTS** Softkey displays the message window on the PFD. The following airspace alerts are displayed in the message window:

Message	Comments
INSIDE ARSPC – Inside airspace.	The aircraft is inside the special use airspace.
ARSPC AHEAD – Airspace ahead – less than 10 minutes.	Special use airspace is ahead of aircraft. The aircraft penetrates the airspace within 10 minutes.
ARSPC NEAR – Airspace near and ahead.	Special use airspace is near and ahead of the aircraft position.
ARSPC NEAR – Airspace near – less than 2 nm.	Special use airspace is within 2 nm of the aircraft position.

Table 5-6 PFD Airspace Alert Messages

5.5 DIRECT-TO-NAVIGATION

The Direct-to method of navigation, initiated by pressing the **Direct-to** Key on either the MFD or PFD, is quicker to use than a flight plan when the desire is to navigate to a single point such as a nearby airport.

Once a direct-to is activated, the G1000 establishes a point-to-point course line from the present position to the selected direct-to destination. Course guidance is provided until the direct-to is replaced with a new direct-to or flight plan, or cancelled.

A vertical navigation (VNV) direct-to creates a descent path (and provides guidance to stay on the path) from the current altitude to a selected altitude at the direct-to waypoint. Vertical navigation is based on barometric altitudes, not on GPS altitude, and is used for cruise and descent phases of flight.

The Direct-to Window allows selection and activation of direct-to navigation. The Direct-to Window displays selected direct-to waypoint data on the PFD and the MFD.



Figure 5-51 Direct-to Window - MFD

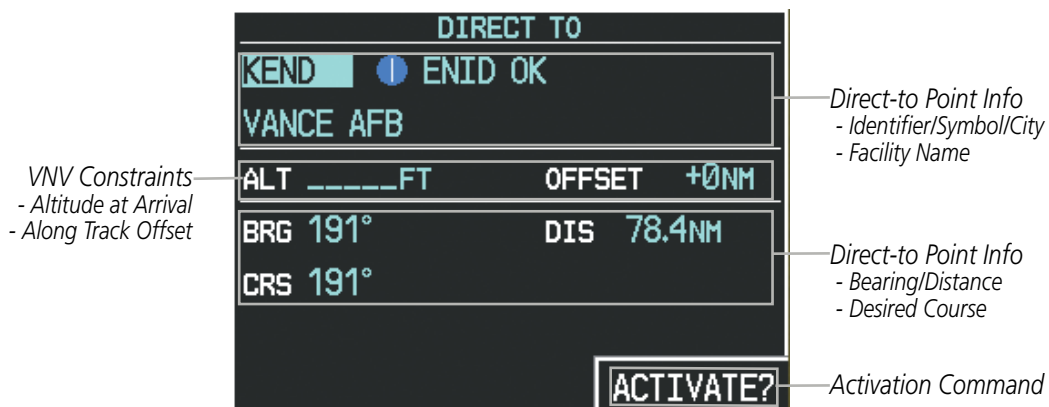

Figure 5-52 Direct-to Window - PFD

Any waypoint can be entered as a direct-to destination from the Direct-to Window.

Entering a waypoint identifier, facility name, or city as a direct-to destination:

- 1) Press the **Direct-to** Key. The Direct-to Window is displayed (with the active flight plan waypoint as the default selection or a blank waypoint field if no flight plan is active).
- 2) Turn the small **FMS** Knob clockwise to begin entering a waypoint identifier (turning it counter-clockwise brings up the waypoint selection submenu - press the **CLR** Key to remove it), or turn the large **FMS** Knob to select the facility name, or city field and turn the small **FMS** Knob to begin entering a facility name or city. If duplicate entries exist for the entered facility or city name, additional entries can be viewed by turning the small **FMS** Knob during the selection process.
- 3) Press the **ENT** Key. The 'Activate?' field is highlighted.
- 4) Press the **ENT** Key to activate the direct-to.

Any waypoint contained in the active flight plan can be selected as a direct-to waypoint from the Direct-to Window, the Active Flight Plan Page, or the Active Flight Plan Window.

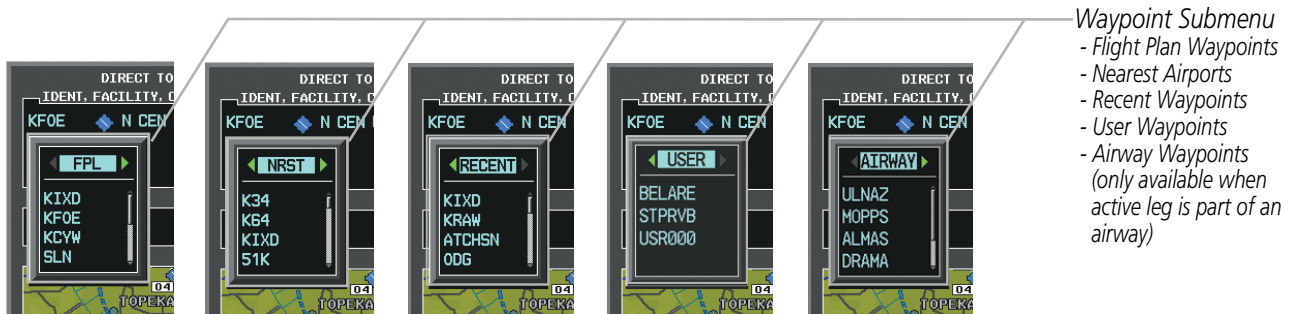

Figure 5-53 Waypoint Submenu

Selecting an active flight plan waypoint as a direct-to destination:

- 1) While navigating an active flight plan, press the **Direct-to** Key. The Direct-to Window is displayed with the active flight plan waypoint as the default selection.
- 2) Turn the small **FMS** Knob counter-clockwise to display a list of flight plan waypoints (the FPL list is populated only when navigating a flight plan).
- 3) Select the desired waypoint.
- 4) Press the **ENT** Key. The cursor is now displayed on 'ACTIVATE?'.
- 5) Press the **ENT** Key again to activate the direct-to.

Or:

- 1) Select the Active Flight Plan Page on the MFD, or the Active Flight Plan Window on the PFD.
- 2) Select the desired waypoint.
- 3) Press the **Direct-to** Key.
- 4) Press the **ENT** Key. The cursor is now displayed on 'ACTIVATE?'.
- 5) Press the **ENT** Key again to activate the direct-to.

Any NRST, RECENT, USER, or AIRWAY waypoints can be selected as a direct-to destination in the Direct-to Window.

Selecting a NRST, RECENT, USER, or AIRWAY waypoint as a direct-to destination:

- 1) Press the **Direct-to** Key. The Direct-to Window is displayed (with the active flight plan destination as the default selection or a blank destination if no flight plan is active).
- 2) Turn the small **FMS** Knob counter-clockwise to display a list of FPL waypoints (the FPL list is populated only when navigating a flight plan, and the AIRWAY list is available only when the active leg is part of an airway).
- 3) Turn the small **FMS** Knob clockwise to display the NRST, RECENT, USER, or AIRWAY waypoints.
- 4) Turn the large **FMS** Knob clockwise to select the desired waypoint.
- 5) Press the **ENT** Key. The cursor is now displayed on 'ACTIVATE?'
- 6) Press the **ENT** Key again to activate the direct-to.

The Direct-to Window can be displayed from any page and allows selection and activation of direct-to navigation. If the direct-to is initiated from any page except the WPT pages, the default waypoint is the active flight plan waypoint (if a flight plan is active) or a blank waypoint field. Direct-to requests on any WPT page defaults to the displayed waypoint.

Selecting any waypoint as a direct-to destination:

- 1) Select the page or window containing the desired waypoint type and select the desired waypoint.
- 2) Press the **Direct-to** Key to display the Direct-to Window with the selected waypoint as the direct-to destination.
- 3) Press the **ENT** Key. The cursor is now displayed on 'ACTIVATE?'
- 4) Press **ENT** again to activate the direct-to.

Selecting a nearby airport as a direct-to destination:

- 1) Press the **NRST** Softkey on the PFD; or turn the **FMS** Knob to display the Nearest Airports Page and press the **FMS** Knob.
- 2) Select the desired airport (the nearest one is already selected).
- 3) Press the **Direct-to** Key.
- 4) Press the **ENT** Key. The cursor is now displayed on 'ACTIVATE?'
- 5) Press the **ENT** Key again to activate the direct-to.

Direct-to destinations may also be selected by using the pointer on the navigation map pages. If no airport, NAVAID, or user waypoint exists at the desired location, a temporary waypoint named 'MAPWPT' is automatically created at the location of the map arrow.

Selecting a waypoint as a direct-to destination using the pointer:

- 1) From a navigation map page, press the **Joystick** to display the pointer.
- 2) Move the **Joystick** to place the pointer at the desired destination location.
- 3) If the pointer is placed on an existing airport, NAVAID, or user waypoint, the waypoint name is highlighted.
- 4) Press the **Direct-to** Key to display the Direct-to Window with the selected point entered as the direct-to destination.

- 5) Press the **ENT** Key. The cursor is now displayed on 'ACTIVATE?'.
- 6) Press the **ENT** Key again to activate the direct-to.

Cancelling a Direct-to:

- 1) Press the **Direct-to** Key to display the Direct-to Window.
- 2) Press the **MENU** Key.
- 3) With 'Cancel Direct-To NAV' highlighted, press the **ENT** Key. If a flight plan is still active, the G1000 resumes navigating the flight plan along the closest leg.

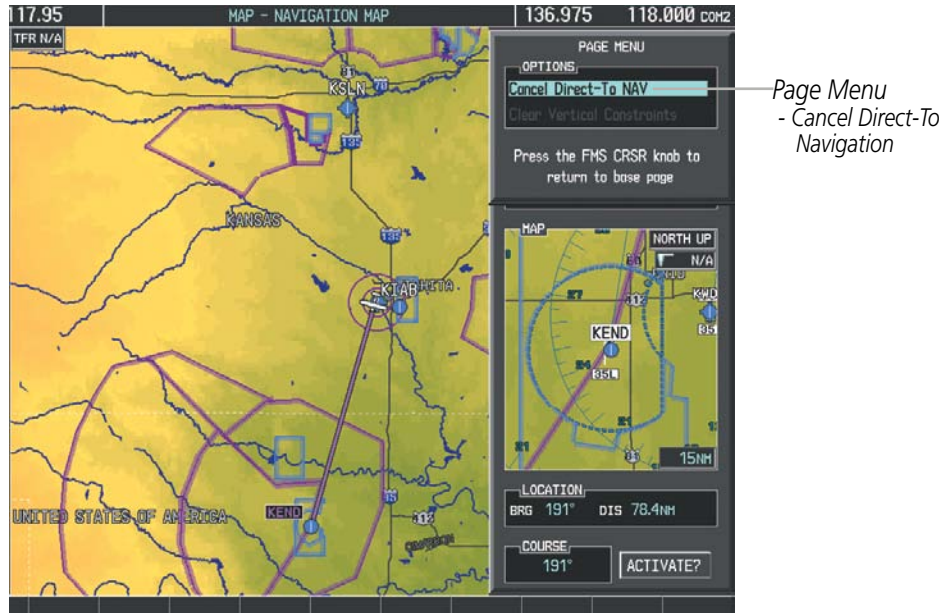

Figure 5-54 Direct-to Window - Cancelling Direct-to Navigation

When navigating a direct-to, the G1000 sets a direct great circle course to the selected destination. The course to a destination can also be manually selected using the course field ('COURSE') on the Direct-to Window.

Selecting a manual direct-to course:

- 1) Press the **Direct-to** Key. The Direct-to Window is displayed with the destination field highlighted.
- 2) Highlight the course field.
- 3) Enter the desired course.
- 4) Press the **ENT** Key. The cursor is now displayed on 'ACTIVATE?'.
- 5) Press the **ENT** Key again to activate the direct-to.

Reselecting the direct course from the current position:

- 1) Press the **Direct-to** Key. The Direct-to Window is displayed with the destination field highlighted.
- 2) Press the **ENT** Key. The cursor is now displayed on 'ACTIVATE?'.
- 3) Press the **ENT** Key again to activate the direct-to.

A direct-to with altitude constraints creates a descent path (and provides guidance to stay on the path) from the aircraft's current altitude to the altitude of the direct-to waypoint. The altitude is reached at the waypoint, or at the specified distance along the flight path if an offset distance has been entered. All VNV altitudes prior to the direct-to destination are removed from the active flight plan upon successful activation of the direct-to. All VNV altitudes following the direct-to waypoint are retained. See the section on Vertical Navigation for more information regarding the use and purpose of VNV altitudes and offset distances.

Entering a VNV altitude and along-track offset for the waypoint:

- 1) Press the **Direct-to** Key to display the Direct-to Window.
- 2) Turn the large **FMS** Knob to place the cursor over the 'VNV' altitude field.
- 3) Enter the desired altitude.
- 4) Press the **ENT** Key. The option to select MSL or AGL is now displayed.
- 5) Turn the small **FMS** Knob to select 'MSL' or 'AGL'.
- 6) Press the **ENT** Key. The cursor is now flashing in the VNV offset distance field.
- 7) Enter the desired along-track distance before the waypoint.
- 8) Press the **ENT** Key. The 'Activate?' field is highlighted.
- 9) Press the **ENT** Key to activate.

Removing a VNV altitude constraint:

- 1) Press the **Direct-to** Key to display the Direct-to Window.
- 2) Press the **MENU** Key.
- 3) With 'Clear Vertical Constraints' highlighted, press the **ENT** Key.

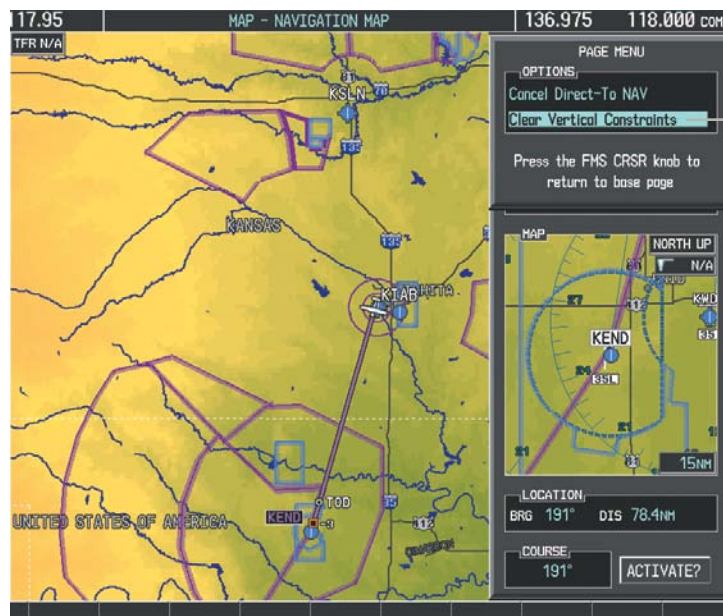

Page Menu
- Clear Vertical Navigation Constraints

Figure 5-55 Direct-to Window - Clearing Vertical Constraints

5.6 FLIGHT PLANNING

Flight planning on the G1000 consists of building a flight plan by entering waypoints one at a time, adding waypoints along airways, and inserting departures, airways, arrivals, or approaches as needed. The G1000 allows flight planning information to be entered from either the MFD or PFD. The flight plan is displayed on maps using different line widths, colors, and types, based on the type of leg and the segment of the flight plan currently being flown (departure, enroute, arrival, approach, or missed approach).

Flight Plan Leg Type	Symbol
Active non-heading Leg	
Active heading Leg	
Non-heading Leg in the current flight segment	
Heading Leg not in the current flight segment	
Non-heading Leg not in the active flight segment	
Turn Anticipation Arc	

Table 5-7 Flight Plan Leg Symbols

Up to 99 flight plans with up to 99 waypoints each can be created and stored in memory. One flight plan can be activated at a time and becomes the active flight plan. The active flight plan is erased when the system is turned off and overwritten when another flight plan is activated. When storing flight plans with an approach, departure, or arrival, the G1000 uses the waypoint information from the current database to define the waypoints. If the database is changed or updated, the G1000 automatically updates the information if the procedure has not been modified. If an approach, departure, or arrival procedure is no longer available, the procedure is deleted from the affected stored flight plan(s), and an alert is displayed (see Miscellaneous Messages in Appendix A) advising that one or more stored flight plans need to be edited.

Whenever an approach, departure, or arrival procedure is loaded into the active flight plan, a set of approach, departure, or arrival waypoints is inserted into the flight plan along with a header line describing the instrument procedure the pilot selected. The original enroute portion of the flight plan remains active (unless an instrument procedure is activated) when the procedure is loaded.

When the database is updated, the airways need to be reloaded also. Each airway segment is reloaded from the database given the entry waypoint, the airway identifier and the exit waypoint. This reloads the sequence of waypoints between the entry and exit waypoints (the sequence may change when the database is updated). The update of an airway can fail during this process. If that happens, the airway waypoints are changed to regular (non-airway) flight plan waypoints, and an alert is displayed (see Miscellaneous Messages in Appendix A).

The following could cause the airway update to fail:

- Airway identifier, entry waypoint or exit waypoint not found in the new database.
- Airway entry/exit waypoint is not an acceptable waypoint for the airway – either the waypoint is no longer on the airway, or there is a new directional restriction that prevents it being used.
- Loading the new airway sequence would exceed the capacity of the flight plan.

FLIGHT PLAN CREATION

There are three methods to create or modify a flight plan:

- Active Flight Plan Page on the MFD (create/modify the active flight plan)
- Active Flight Plan Window on the PFD (create/modify the active flight plan)
- Flight Plan Catalog Page on the MFD (create/modify a stored flight plan)

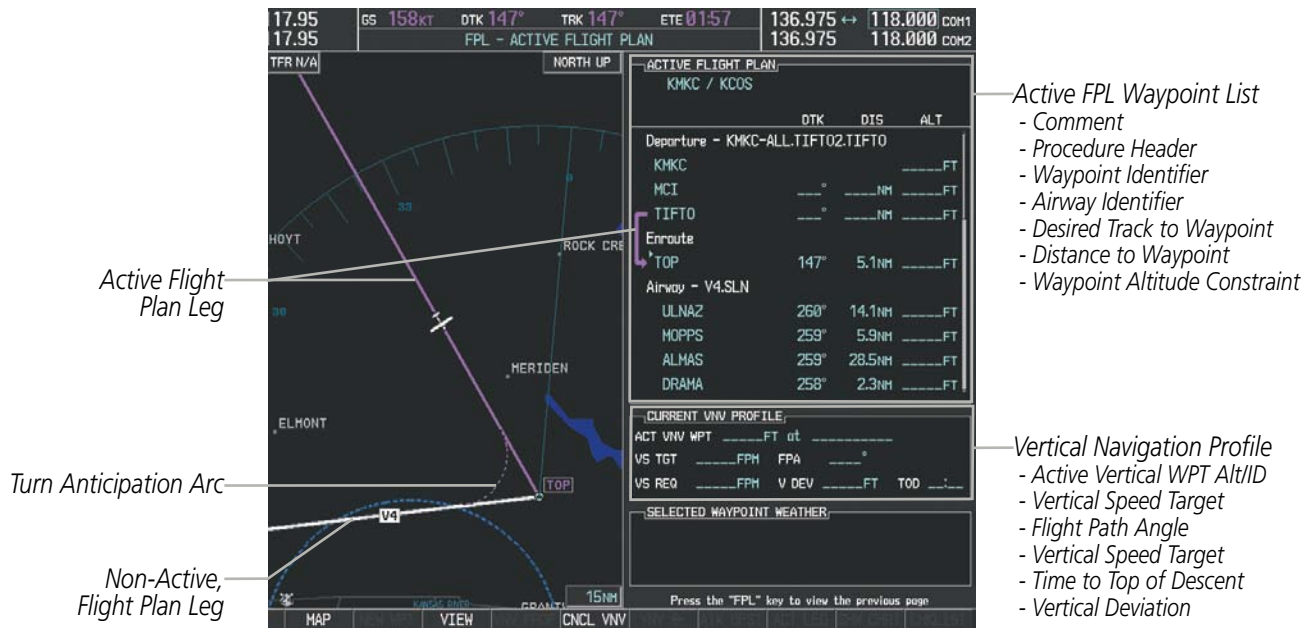

Figure 5-56 Active Flight Plan Page

- SYSTEM OVERVIEW
- FLIGHT INSTRUMENTS
- EIS
- AUDIO PANEL & CNS
- FLIGHT MANAGEMENT
- HAZARD AVOIDANCE
- AFCS
- ADDITIONAL FEATURES
- APPENDICES
- INDEX

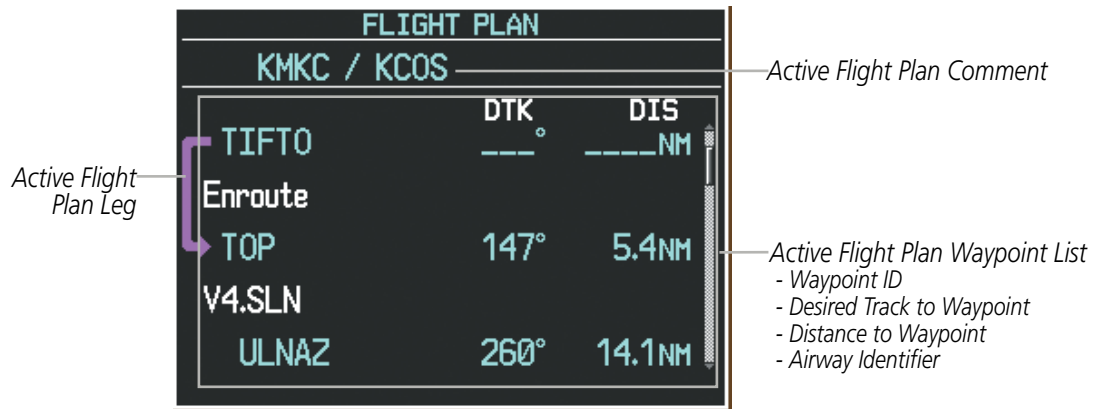

Figure 5-57 Active Flight Plan Window on PFD

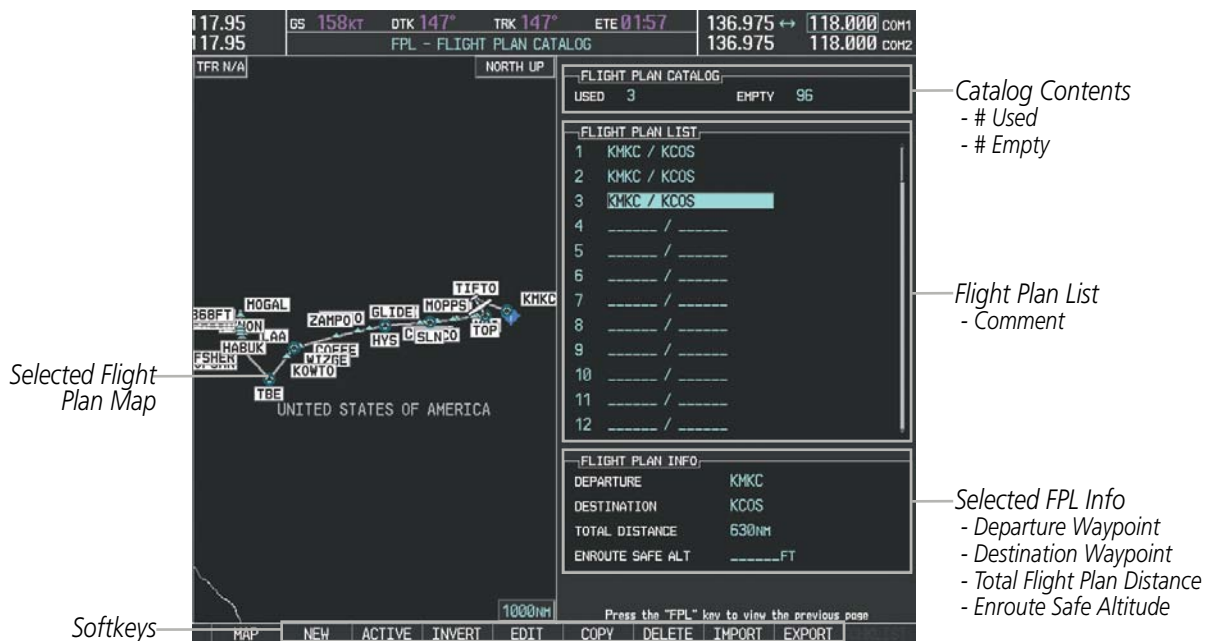

Figure 5-58 Flight Plan Catalog Page

The active flight plan is listed on the active Flight Plan Page on the MFD, and in the Active Flight Plan Window on the PFD. It is the flight plan to which the G1000 is currently providing guidance, and is shown on the navigation maps. Stored flight plans are listed on the Flight Plan Catalog Page, and are available for activation (becomes the active flight plan).

Creating an active flight plan:

- 1) Press the **FPL** Key.
- 2) Press the **FMS** Knob to activate the cursor (only on MFD).

- 3) Turn the small **FMS** Knob to display the Waypoint Information Window. (Turning it clockwise displays a blank Waypoint Information Window, turning it counter-clockwise displays the Waypoint Information Window with a waypoint selection submenu allowing selection of active flight plan, nearest, recent, user, or airway waypoints).
- 4) Enter the identifier, facility, or city name of the departure waypoint or select a waypoint from the submenu of waypoints and press the **ENT** Key. The active flight plan is modified as each waypoint is entered.
- 5) Repeat step numbers 3 and 4 to enter each additional flight plan waypoint.
- 6) When all waypoints have been entered, press the **FMS** Knob to remove the cursor.

Creating a stored flight plan:

- 1) Press the **FPL** Key.
- 2) Turn the small **FMS** Knob clockwise to display the Flight Plan Catalog Page.
- 3) Press the **NEW** Softkey; or press the **MENU** Key, highlight 'Create New Flight Plan', and press the **ENT** Key to display a blank flight plan for the first empty storage location.
- 4) Turn the small **FMS** Knob to display the Waypoint Information Window. (Turning it clockwise displays a blank Waypoint Information Window, turning it counter-clockwise displays the Waypoint Information Window with a waypoint selection submenu allowing selection of active flight plan, nearest, recent, user, or airway waypoints).
- 5) Enter the identifier, facility, or city name of the departure waypoint or select a waypoint from the submenu of waypoints and press the **ENT** Key.
- 6) Repeat step numbers 4 and 5 to enter each additional flight plan waypoint.
- 7) When all waypoints have been entered, press the **FMS** Knob to return to the Flight Plan Catalog Page. The new flight plan is now in the list.

Flight plans can be imported from an SD Card or exported to an SD Card from the Stored Flight Plan Page.

Importing a Flight Plan from an SD Card

- 1) Insert the SD card containing the flight plan in the top card slot on the MFD.
- 2) Press the **FPL** Key to display the Active Flight Plan Page on the MFD.
- 3) Turn the small **FMS** Knob to select the Flight Plan Catalog Page.
- 4) Press the **FMS** Knob to activate the cursor.
- 5) Turn either **FMS** Knob to highlight an empty or existing flight plan.
- 6) Press the **IMPORT** Softkey; or press the **MENU** Key, select "Import Flight Plan", and press the **ENT** Key.

If an empty slot is selected, a list of the available flight plans on the SD card will be displayed.

Or:

If an existing flight plan is selected, an "Overwrite existing flight plan? OK or CANCEL" prompt is displayed. Press the **ENT** Key to choose to overwrite the selected flight plan and see the list of available flight plans on the SD card. If overwriting the existing flight plan is not desired, select "CANCEL" using the **FMS** Knob, press the **ENT** Key, select another flight plan slot, and press the **IMPORT** Softkey again.

- 7) Turn the small **FMS** Knob to highlight the desired flight plan for importing.
- 8) Press the **ENT** Key to initiate the import.
- 9) Press the **ENT** Key again to confirm the import.

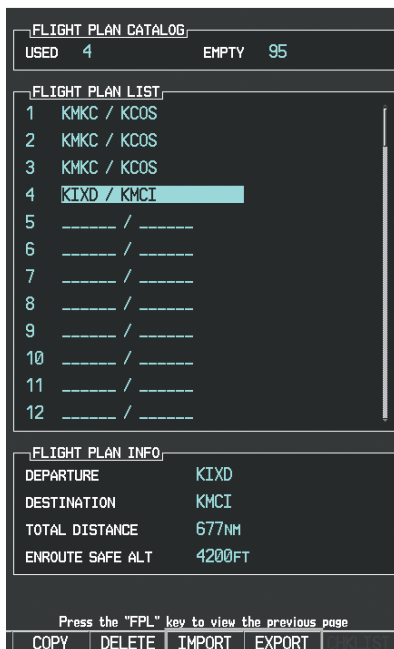

Import/Export Softkeys

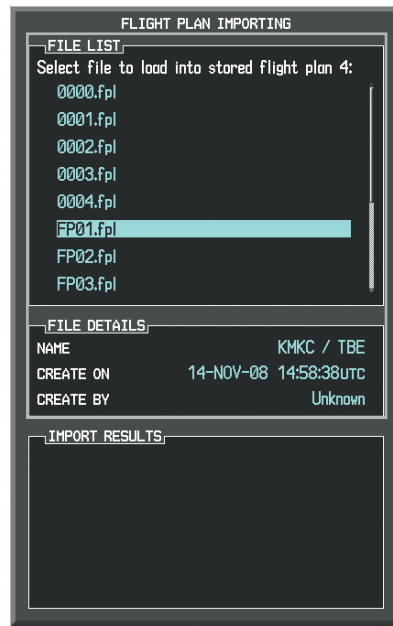

List of Flight Plans to Import & Details for the Selected File

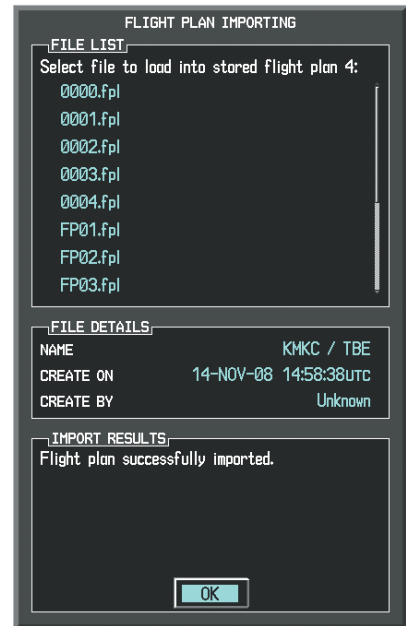

Import Successful

Figure 5-59 Flight Plan Import



NOTE: If the imported flight plan contains a waypoint with a name that duplicates the name of a waypoint already stored on the system, the system compares the coordinates of the imported waypoint with those of the existing waypoint. If the coordinates are different, the imported waypoint is automatically renamed by adding characters to the end of the name.

Exporting a Flight Plan to an SD Card

- 1) Insert the SD card into the top card slot on the MFD.
- 2) Press the **FPL** Key to display the Active Flight Plan Page on the MFD.
- 3) Turn the small **FMS** Knob to select the Flight Plan Catalog Page.
- 4) Press the **FMS** Knob to activate the cursor.
- 5) Turn the large **FMS** Knob to highlight the flight plan to be exported.
- 6) Press the **EXPORT** Softkey; or press the **MENU** Key, select "Export Flight Plan".
- 7) If desired, change the name for the exported file by turning the large **FMS** Knob to the left to highlight the name, then use the small and large **FMS** knobs to enter the new name, and press the **ENT** Key.
- 8) Press the **ENT** Key to initiate the export.
- 9) Press the **ENT** Key to confirm the export.



NOTE: The exported flight plan will not contain any procedures or airways.



Import/Export Softkeys



Stored Flight Plan to be Exported & Exported Flight Plan Name

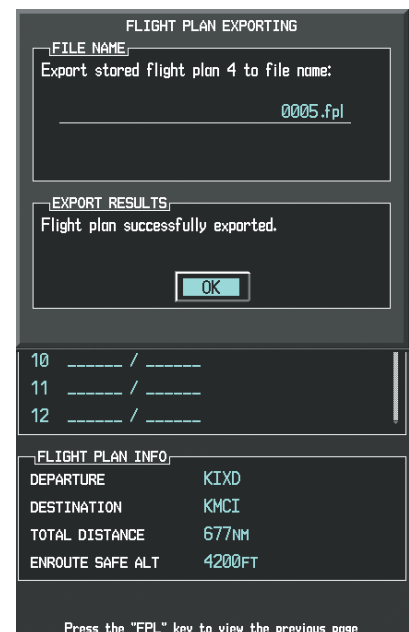

Export Successful

Figure 5-60 Flight Plan Export

SYSTEM OVERVIEW

FLIGHT INSTRUMENTS

EIS

AUDIO PANEL & CNS

FLIGHT MANAGEMENT

HAZARD AVOIDANCE

AFCS

ADDITIONAL FEATURES

APPENDICES

INDEX

SYSTEM OVERVIEW

FLIGHT INSTRUMENTS

EIS

AUDIO PANEL & CNS

FLIGHT MANAGEMENT

HAZARD AVOIDANCE

AFCS

ADDITIONAL FEATURES

APPENDICES

INDEX

ADDING WAYPOINTS TO AN EXISTING FLIGHT PLAN

Waypoints can be added to the active flight plan or any stored flight plan. Choose the flight plan, select the desired point of insertion, enter the waypoint, and it is added in front of the selected waypoint. Flight plans are limited to 99 waypoints (including waypoints within airways and procedures). If the number of waypoints in the flight plan exceeds 99, the message “Flight plan is full. Remove unnecessary waypoints.” appears and the new waypoint(s) are not added to the flight plan.

Stored Flight Plan Selected

- Memory Slot
- Comment
- Procedure Identifier
- Waypoint Identifier
- Airway Identifier
- Desired Track to Waypoint
- Distance to Waypoint
- Waypoint Altitude Constraint

Softkeys

DTK	DIS	ALT
Departure - KMCC-ALLTIFT02TIFT0		
KMCC		
MCI	323° 11.8NM	
TIFT0	287° 57.0NM	
Enroute		
TOP	147° 32.3NM	
Airway - V4.SLN		
ULNAZ	260° 14.1NM	
MOPPS	259° 5.9NM	
ALMAS	259° 28.5NM	
DRAMA	258° 2.3NM	

Figure 5-61 Stored Flight Plan Page

ACTIVE FLIGHT PLAN

ONE WYPT OVER MAX

	DTK	DIS	ALT
KMCC	---	---	---
KEND	222°	223NM	---
KA AO	016°	90.8NM	---
UKL	060°	78.4NM	---
RIS	043°	72.2NM	---
KMCC	043°	0.2NM	---
KEND			
KA AO			
UKL			
RIS			
KMCC			

Flight plan is full. Remove unnecessary waypoints.

CURRENT UNV PROFILE

ACT UNV WPT _____ FT at _____

VS TGT _____ FPM FPA _____ °

VS REQ _____ FPM V DEV _____ FT TOD _____

SELECTED WAYPOINT WEATHER

KA AO 081854Z AUTO 04009KT 020V080 10SM CLR
27/06 A3020 RMK A02 SLP217 T02670061

Flight Plan Full Message

Figure 5-62 Active Flight Plan Page - FPL Full

Adding a waypoint to a stored flight plan:

- 1) On the Flight Plan Catalog Page, press the **FMS** Knob to activate the cursor.
- 2) Highlight the desired flight plan.
- 3) Press the **EDIT** Softkey; or press the **ENT** Key, turn the large **FMS** Knob clockwise to select "EDIT" and press the **ENT** Key. The Stored Flight Plan Page is displayed.
- 4) Select the point in the flight plan to add the new waypoint. The new waypoint is placed directly in front of the highlighted waypoint.
- 5) Turn the small **FMS** Knob to display the Waypoint Information Window. (Turning it clockwise displays a blank Waypoint Information Window, turning it counter-clockwise displays the Waypoint Information Window with a waypoint selection submenu allowing selection of active flight plan, nearest, recent, user, or airway waypoints).
- 6) Enter the identifier, facility, or city name of the waypoint or select a waypoint from the submenu of waypoints and press the **ENT** Key. The new waypoint now exists in the flight plan.



NOTE: If the identifier entered in the Waypoint Information Window has duplicates, a Duplicate Waypoint Window is displayed. Use the FMS Knob to select the correct waypoint.

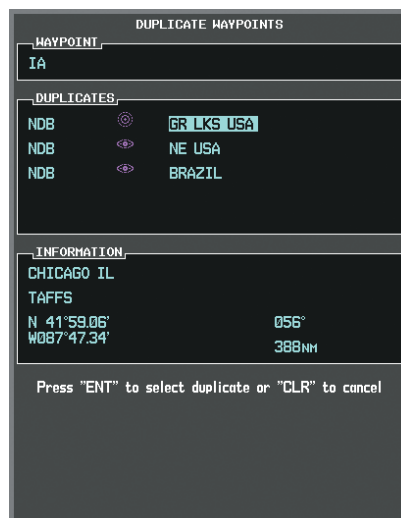

Figure 5-63 Duplicate Waypoints Window

Adding a waypoint to the active flight plan:

- 1) Press the **FPL** Key.
- 2) Press the **FMS** Knob to activate the cursor (not required on the PFD).
- 3) Select the point in the flight plan before which to add the new waypoint. The new waypoint is placed directly in front of the highlighted waypoint.

- 4) Turn the small **FMS** Knob to display the Waypoint Information Window. (Turning it clockwise displays a blank Waypoint Information Window, turning it counter-clockwise displays the Waypoint Information Window with a waypoint selection submenu allowing selection of active flight plan, nearest, recent, user, or airway waypoints).
- 5) Enter the identifier, facility, or city name of the waypoint or select a waypoint from the submenu of waypoints and press the **ENT** Key. The active flight plan is modified as each waypoint is entered.

Creating and adding user waypoints to the active flight plan:

- 1) Press the **Joystick** to activate the panning function on the Active Flight Plan Page and pan to the map location of the desired user waypoint.
- 2) Press the **LD WPT** Softkey; or press the **MENU** Key, select 'Load Waypoint', and press the **ENT** Key. The user waypoint is created with a name of USRxxx (using the next available in sequence) and is added to the end of the active flight plan.

ADDING AIRWAYS TO A FLIGHT PLAN

Airways can be added to the active flight plan or any stored flight plan. Choose a flight plan (add the desired airway entry point if not already in the flight plan), select the waypoint after the desired airway entry point, select the airway, and it is added in front of the selected waypoint. An airway can only be loaded if there is a waypoint in the flight plan that is part of the desired airway and is not part of an arrival or approach procedure. The G1000 also anticipates the desired airway and exit point based on loaded flight plan waypoints.

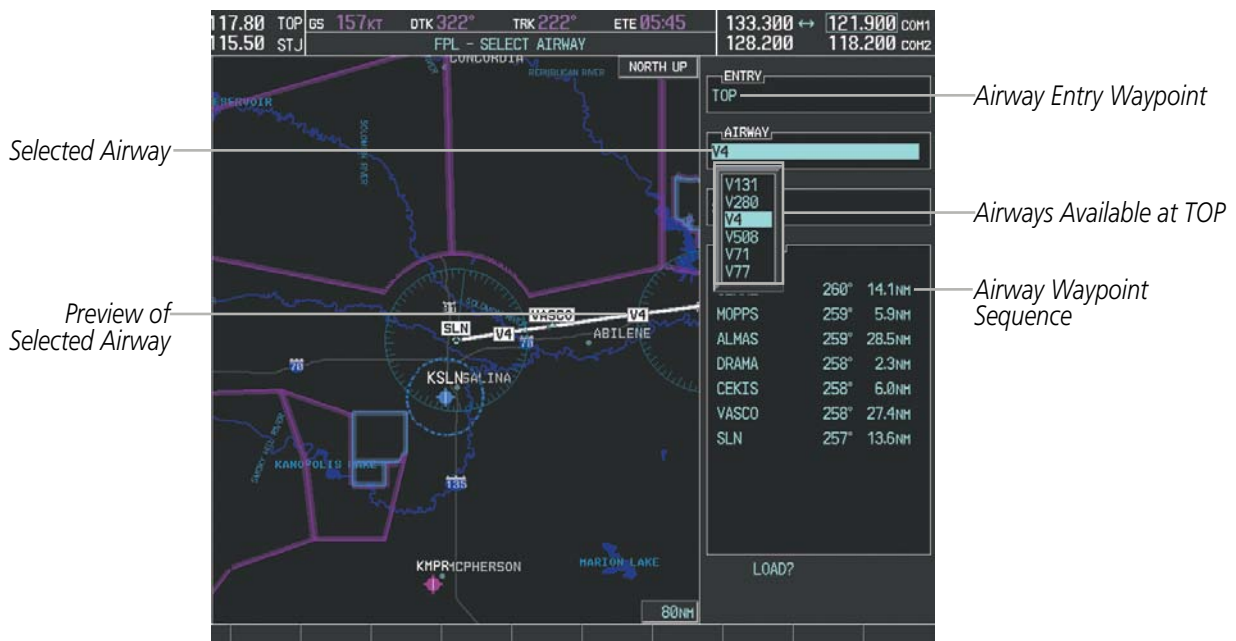

Figure 5-64 Select Airway Page - Selecting Airway

Adding an airway to a flight plan:

- 1) Press the **FPL** Key.
- 2) Press the **FMS** Knob to activate the cursor (not required on the PFD).
- 3) Turn the large **FMS** Knob to highlight the waypoint after the desired airway entry point. If this waypoint is not a valid airway entry point, a valid entry point should be entered at this time.
- 4) Turn the small **FMS** Knob one click clockwise and press the **LD AIRWY** Softkey, or press the **MENU** Key and select "Load Airway". The Select Airway Page is displayed. The **LD AIRWY** Softkey or the "Load Airway" menu item is available only when a valid airway entry waypoint has been chosen (the waypoint ahead of the cursor position).
- 5) Turn the **FMS** Knob to select the desired airway from the list, and press the **ENT** Key. Low altitude airways are shown first in the list, followed by "all" altitude airways, and then high altitude airways.
- 6) Turn the **FMS** Knob to select the desired airway exit point from the list, and press the **ENT** Key. 'LOAD?' is highlighted.
- 7) Press the **ENT** Key. The system returns to editing the flight plan with the new airway inserted.

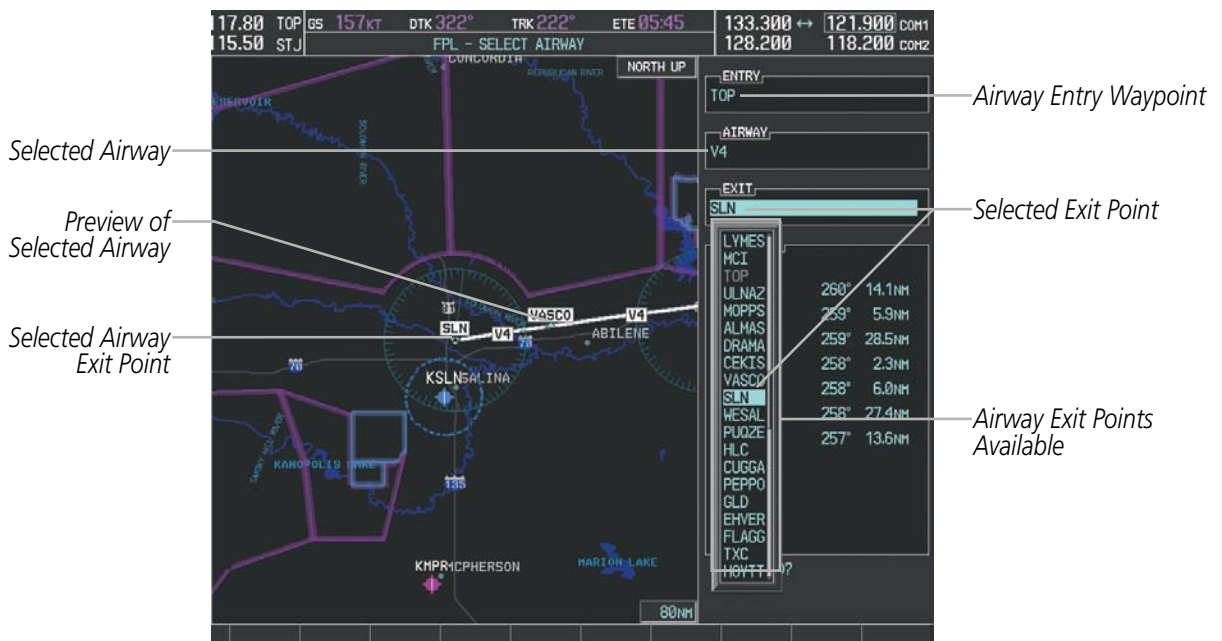
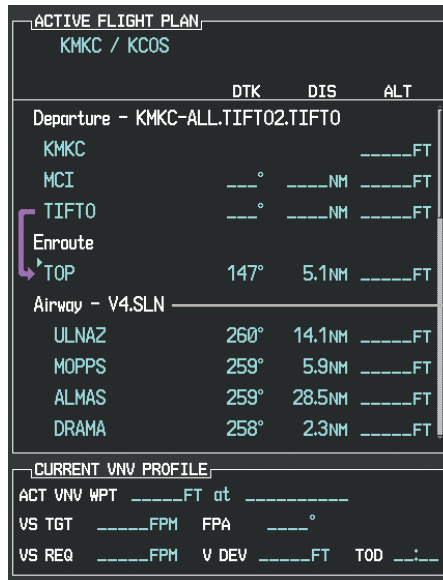

Figure 5-65 Select Airway Page - Selecting Exit Point

- SYSTEM OVERVIEW
- FLIGHT INSTRUMENTS
- EIS
- AUDIO PANEL & CNS
- FLIGHT MANAGEMENT
- HAZARD AVOIDANCE
- AFCS
- ADDITIONAL FEATURES
- APPENDICES
- INDEX



Inserted Airway Header
 - Airway Identifier: [airway identifier].[exit waypoint identifier]
 (e.g., V4.SLN)

Figure 5-66 Active Flight Plan Page - Airway Inserted

RESTRICTIONS ON ADDING AIRWAYS

Some airways have directional restrictions on all or part of the route. Airway “A2” in Europe has a directional restriction over the whole route such that it can be flown only in the direction MTD-ABB-BNE-DEVAL.

Airway “UR975” in North Africa has more complicated directional restrictions within the list of airway waypoints AMANO, VAKOR, LIBRO, NELDA, DIRKA, GZO, KOSET, and SARKI:

- Starting from AMANO, the airway can be flown only to LIBRO.
- Starting from SARKI, the airway can be flown only to LIBRO.
- Between NELDA and GZO, the airway can be flown in either direction.

In the US, airways that are “one-way” for specified hours of operation are not uncommon. These airways are always bidirectional in the G1000 database.

The system only allows correct airway sequences to be inserted. If the pilot subsequently inverts the flight plan, the system inverts the airway waypoint sequence and removes the airway header.

ADDING PROCEDURES TO A STORED FLIGHT PLAN

The G1000 allows the pilot to insert pre-defined instrument procedures from the navigation database into a flight plan. The procedures are designed to facilitate routing of traffic leaving an airport (departure), arriving at an airport (arrival), and landing at an airport (approach). See the procedures section for more details.



Figure 5-67 Stored Flight Plan Page

DEPARTURE (DP)

A Departure Procedure (DP) is loaded at the departure airport in the flight plan. Only one departure can be loaded at a time in a flight plan. The route is defined by selection of a departure, the transition waypoints, and a runway.

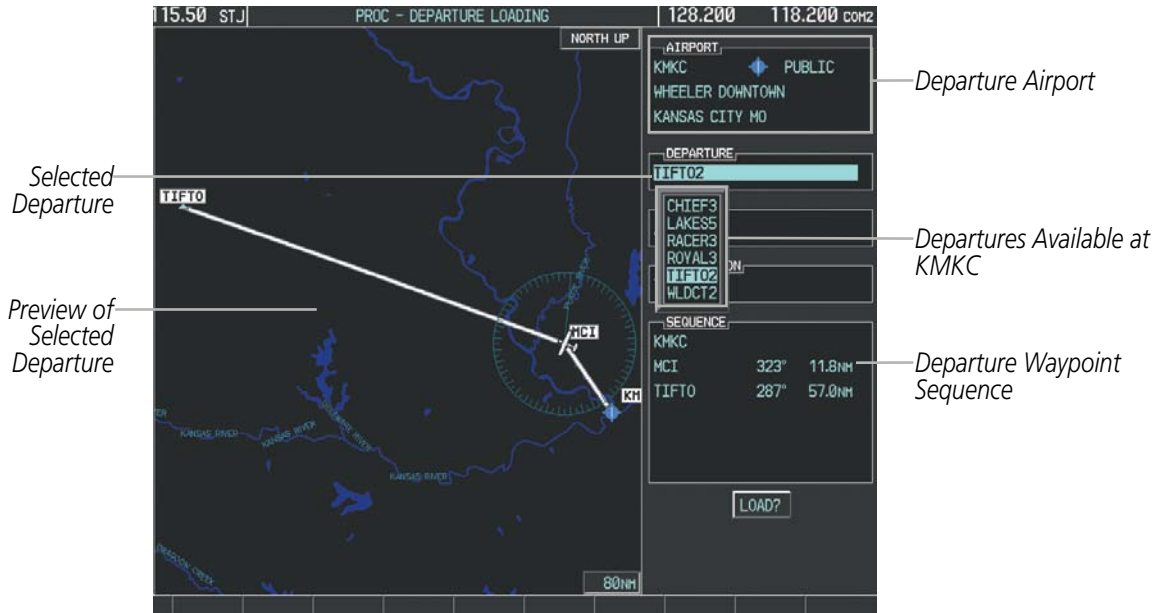

Figure 5-68 Departure Loading Page - Selecting the Departure

Loading a departure procedure into a stored flight plan:

- 1) Select a stored flight plan from the Flight Plan Catalog Page.
- 2) Press the **EDIT** Softkey; or press the **MENU** Key, select 'Edit Flight Plan', and press the **ENT** Key. The Stored Flight Plan Page is displayed.
- 3) Press the **LD DP** Softkey; or press the **MENU** Key, select "Load Departure", and press the **ENT** Key. The Departure Loading Page is displayed.
- 4) Select a departure. Press the **ENT** Key.
- 5) Select a runway served by the selected departure, if required. Press the **ENT** Key.
- 6) Select a transition for the selected departure. Press the **ENT** Key.
- 7) Press the **ENT** Key to load the selected departure procedure.

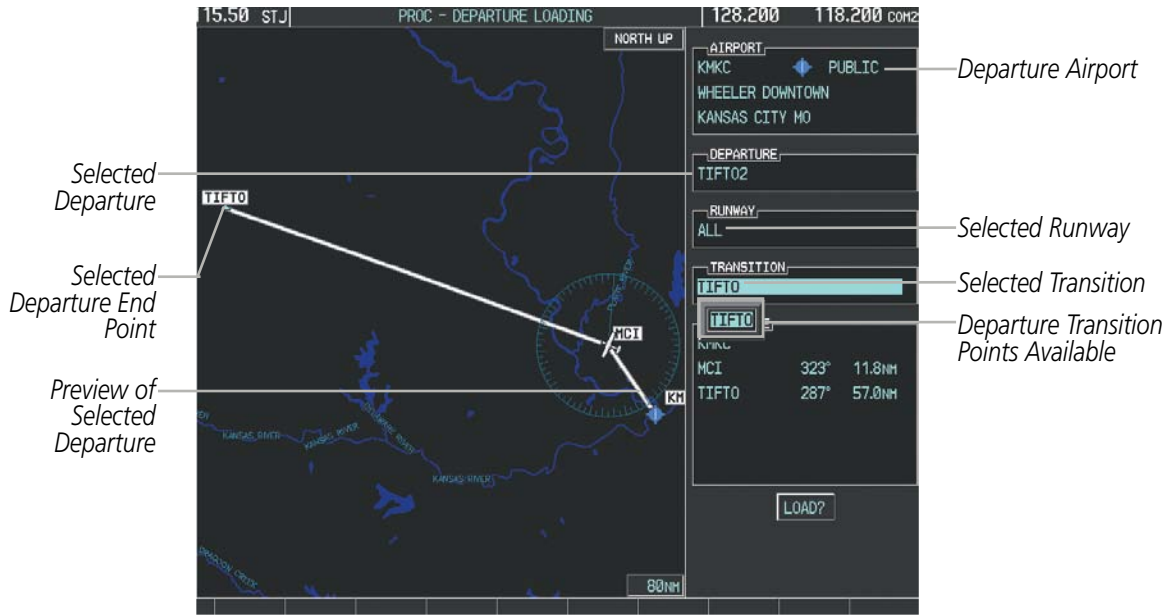
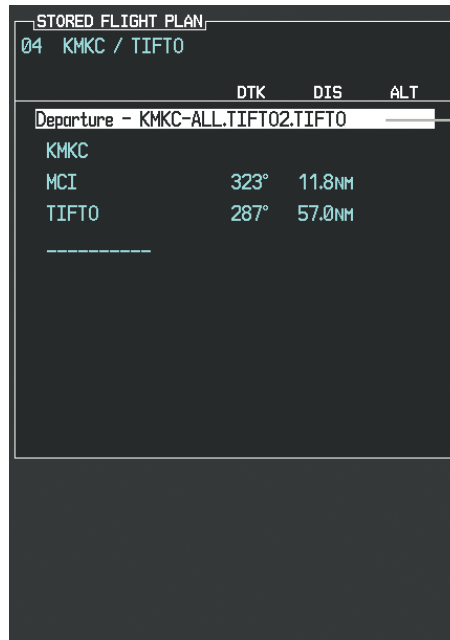

Figure 5-69 Departure Loading Page - Selecting Transition



Inserted Departure Header
 - Departure Identifier: [departure airport]-[departure runway].
 [departure transition].
 [departure end point]
 (e.g., KMKC-ALL.TIFTO2.TIFTO)

Figure 5-70 Stored Flight Plan Page - Departure Inserted

ARRIVAL (STAR)

A Standard Terminal Arrival (STAR) is loaded at the destination airport in the flight plan. Only one arrival can be loaded at a time in a flight plan. The route is defined by selection of an arrival, the transition waypoints, and a runway.

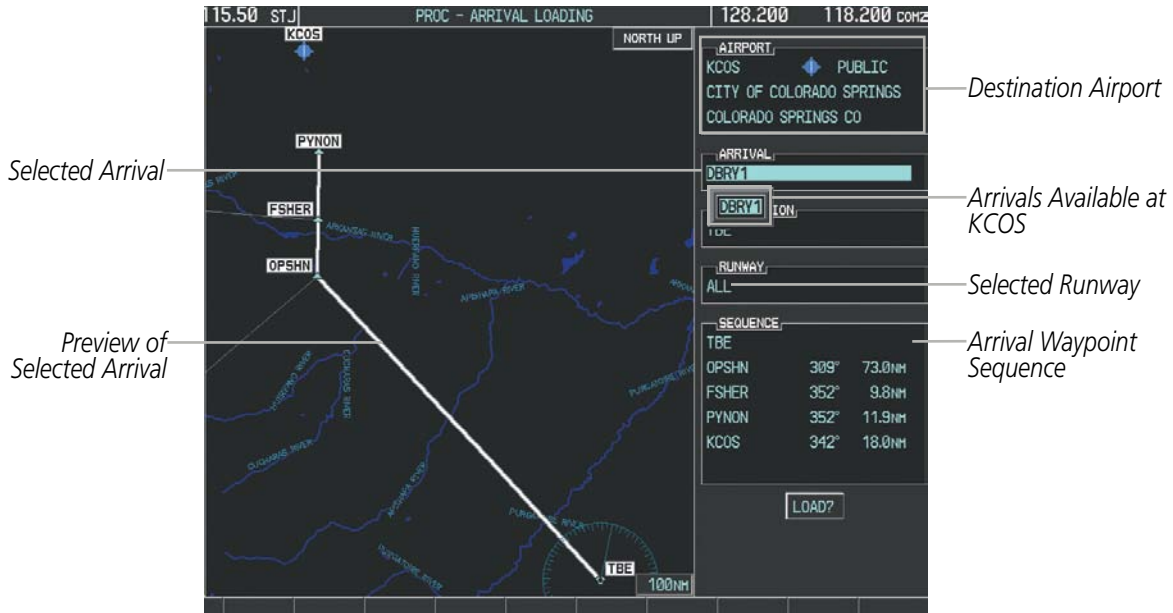

Figure 5-71 Arrival Loading Page - Selecting the Arrival

Loading an arrival procedure into a stored flight plan:

- 1) Select a stored flight plan from the Flight Plan Catalog Page.
- 2) Press the **EDIT** Softkey; or press the **MENU** Key, select 'Edit Flight Plan', and press the **ENT** Key. The Stored Flight Plan Page is displayed.
- 3) Press the **LD STAR** Softkey; or press the **MENU** Key, select "Load Arrival", and press the **ENT** Key. The Arrival Loading Page is displayed.
- 4) Select an arrival. Press the **ENT** Key.
- 5) Select a transition for the selected arrival. Press the **ENT** Key.
- 6) Select a runway served by the selected arrival, if required. Press the **ENT** Key.
- 7) Press the **ENT** Key to load the selected arrival procedure.

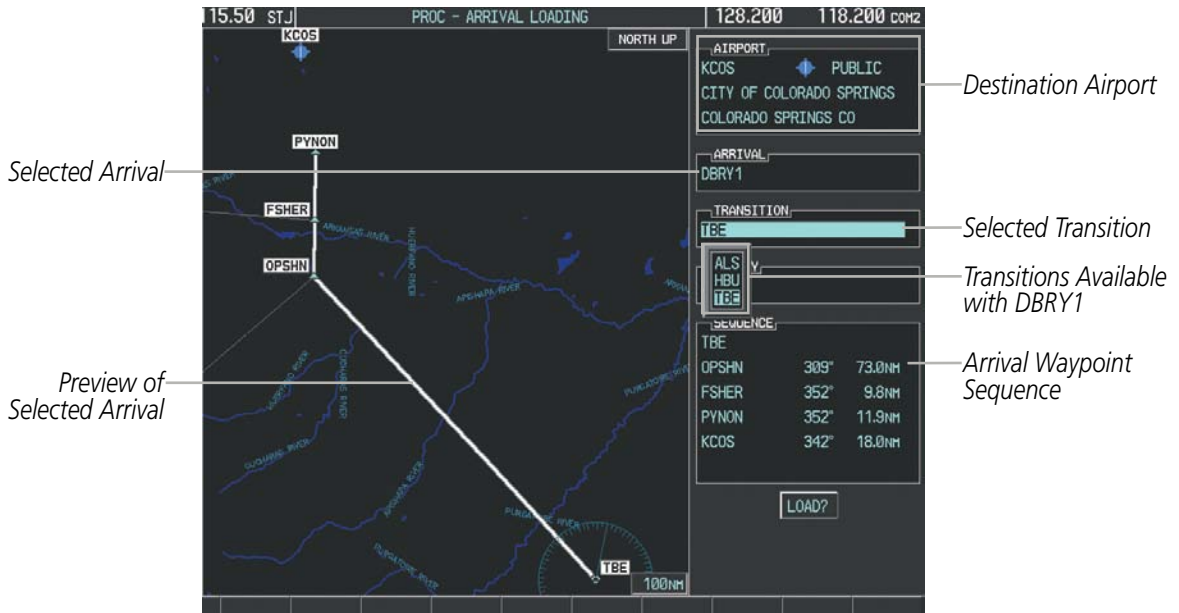
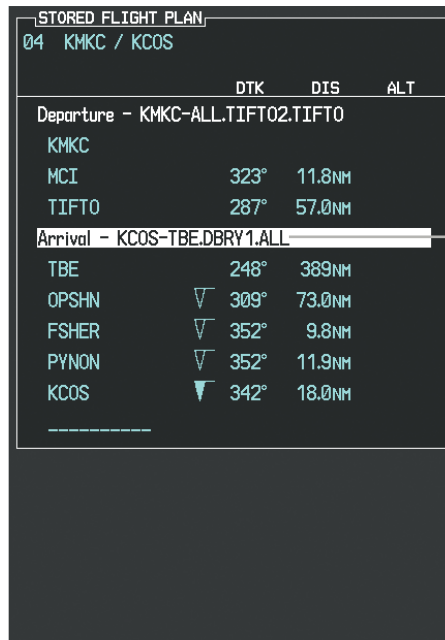

Figure 5-72 Arrival Loading Page - Selecting the Transition



Inserted Arrival Header
 - Arrival Identifier:
 [arrival airport]-[arrival transition].
 [arrival].[arrival runway]
 (e.g., KCOS-ALS.DBRY1.ALL)

Figure 5-73 Stored Flight Plan Page - Arrival Inserted

APPROACH (APPR)

An Approach Procedure (APPR) can be loaded at any airport that has an approach available. Only one approach can be loaded at a time in a flight plan. The route for a selected approach is defined by designating transition waypoints.

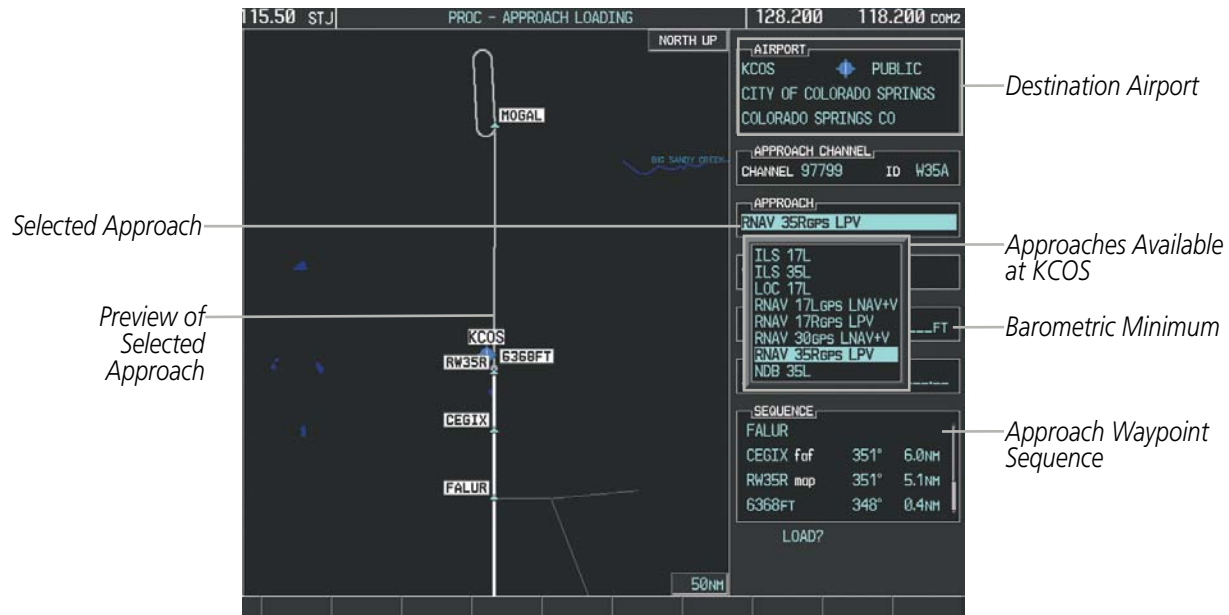

Figure 5-74 Approach Loading Page - Selecting the Approach

Loading an approach procedure into a stored flight plan:

- 1) Select a stored flight plan from the Flight Plan Catalog Page.
- 2) Press the **EDIT** Softkey; or press the **MENU** Key, select 'Edit Flight Plan', and press the **ENT** Key. The Stored Flight Plan Page is displayed.
- 3) Press the **LD APR** Softkey; or press the **MENU** Key, select "Load Approach", and press the **ENT** Key. The Approach Loading Page is displayed.
- 4) Select an approach. Press the **ENT** Key.
- 5) Select a transition for the selected approach. Press the **ENT** Key.
- 6) Press the **ENT** Key to load the selected approach procedure.

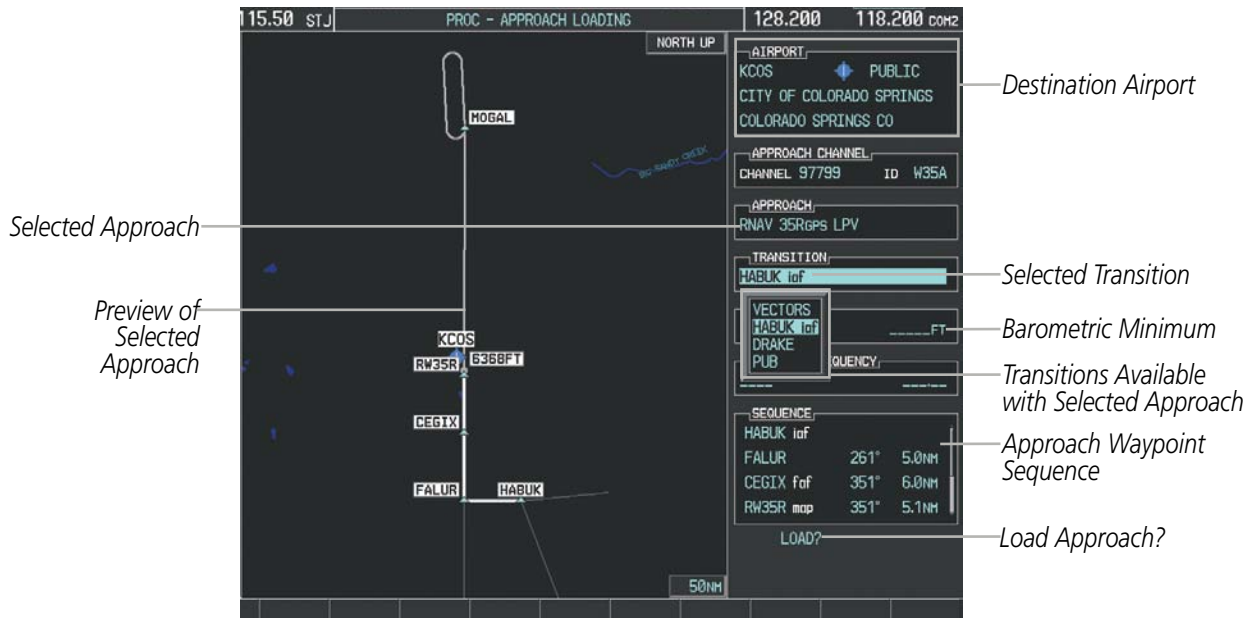

Figure 5-75 Approach Loading Page - Selecting the Transition

STORED FLIGHT PLAN			
04 KMKC / KCOS			
	DTK	DIS	ALT
FSHER	352°	9.8NM	
PYNON	352°	11.9NM	
Approach - KCOS-RNAV 35R6ps LPV			
HABUK lcf	021°	5.9NM	9000FT
FALUR	261°	5.0NM	8600FT
CEGIX fcf	351°	6.0NM	7800FT
RW35R map	351°	5.1NM	
6368FT	348°	0.4NM	6370FT
MOGAL mahp			10000FT
HOLD	168°	6.0NM	

Inserted Approach Header - Approach Identifier: [approach airport].[runway and approach type]

Figure 5-76 Stored Flight Plan Page - Approach Inserted

FLIGHT PLAN STORAGE

The G1000 can store up to 99 flight plans, numbered 1 through 99. The active flight plan is erased when the G1000 is powered off or when another flight plan is activated. Details about each stored flight plan can be viewed on the Flight Plan Catalog Page and on the Stored Flight Plan Page.

Viewing information about a stored flight plan:

- 1) Press the **FPL** Key on the MFD to display the Active Flight Plan Page.
- 2) Turn the small **FMS** Knob clockwise one click to display the Flight Plan Catalog Page.

- 3) Press the **FMS** Knob to activate the cursor and turn the **FMS** Knob to highlight the desired flight plan.
- 4) The Flight Plan Information is displayed showing departure, destination, total distance, and enroute safe altitude information for the selected Flight Plan.
- 5) Press the **EDIT** Softkey to open the Stored Flight Plan Page and view the waypoints in the flight plan.
- 6) Press the **FMS** Knob to exit the Stored Flight Plan Page.

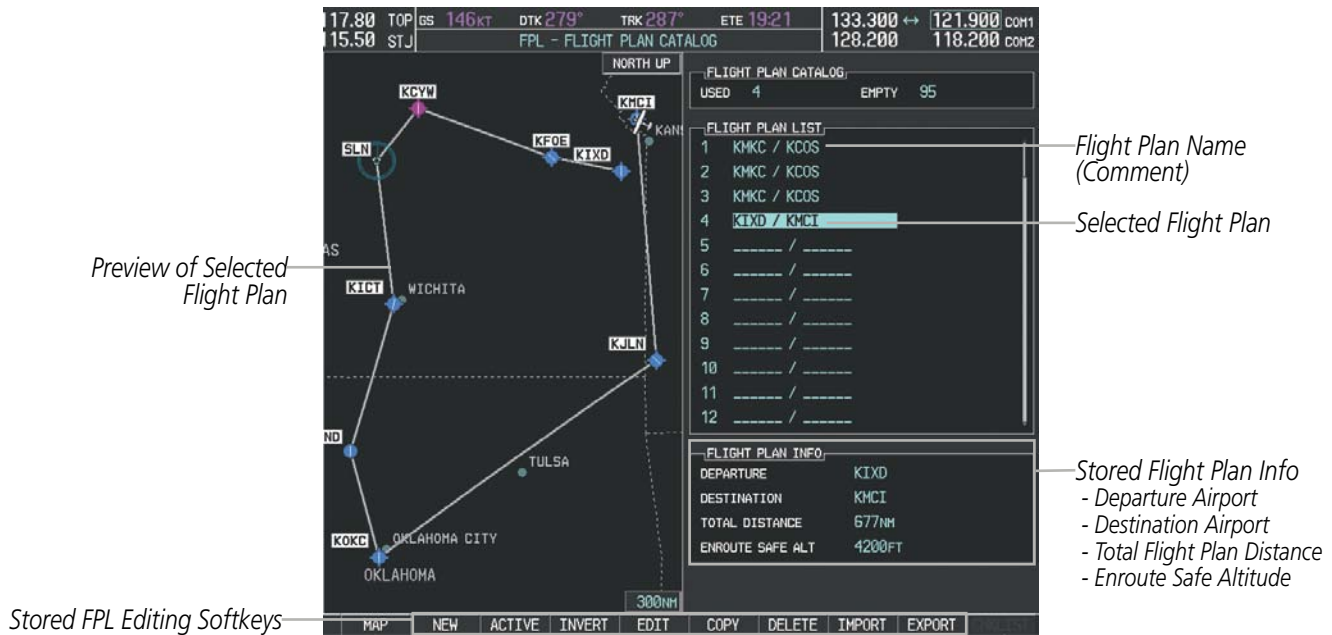

Figure 5-77 Stored Flight Plan Information

Storing an active flight plan from the Active Flight Plan Page or the Active Flight Plan Window:

- 1) Press the **MENU** Key.
- 2) Highlight 'Store Flight Plan'.
- 3) Press the **ENT** Key.
- 4) With 'OK' highlighted, press the **ENT** Key. The flight plan is stored in the next available position in the flight plan list on the Flight Plan Catalog Page.

ACTIVATE A FLIGHT PLAN

Activating a stored flight plan erases the active flight plan and replaces it with the flight plan being activated. Inverting a stored flight plan reverses the waypoint order, erases the active flight plan, and replaces it with the flight plan being activated (the stored flight plan is not changed).

Activating a stored flight plan on the MFD:

- 1) Press the **FPL** Key and turn the small **FMS** Knob to display the Flight Plan Catalog Page.
- 2) Press the **FMS** Knob to activate the cursor, and turn the **FMS** Knob to highlight the desired flight plan.

- 3) Press the **ACTIVE** Softkey; or press the **ENT** Key twice; or press the **MENU** Key, highlight 'Activate Flight Plan', and press the **ENT** Key. The 'Activate Stored Flight Plan?' window is displayed.
- 4) With 'OK' highlighted, press the **ENT** Key. To cancel the request, press the **CLR** Key, or highlight 'CANCEL' and press the **ENT** Key.

Inverting and activating a stored flight plan on the MFD:

- 1) Press the **FPL** Key and turn the small **FMS** Knob to display the Flight Plan Catalog Page.
- 2) Press the **FMS** Knob to activate the cursor, and turn the **FMS** Knob to highlight the desired flight plan.
- 3) Press the **INVERT** Softkey; or press the **MENU** Key, highlight 'Invert & Activate FPL?', and press the **ENT** Key. The 'Invert and activate stored flight plan?' window is displayed.
- 4) With 'OK' highlighted, press the **ENT** Key. To cancel the request, press the **CLR** Key, or highlight 'CANCEL' and press the **ENT** Key.

COPY A FLIGHT PLAN

The G1000 allows copying a flight plan into a new flight plan memory slot, allowing editing, etc., without affecting the original flight plan. This can be used to duplicate an existing stored flight plan for use in creating a modified version of the original stored flight plan.

Copying a stored flight plan on the MFD:

- 1) Press the **FPL** Key and turn the small **FMS** Knob to display the Flight Plan Catalog Page.
- 2) Press the **FMS** Knob to activate the cursor, and turn the **FMS** Knob to highlight the desired flight plan.
- 3) Press the **COPY** Softkey; or press the **MENU** Key, highlight 'Copy Flight Plan', and press the **ENT** Key. The 'Copy to Flight Plan XX?' window is displayed.
- 4) With 'OK' highlighted, press the **ENT** Key to copy the flight plan. To cancel the request, press the **CLR** Key, or highlight 'CANCEL' and press the **ENT** Key.

DELETE A STORED FLIGHT PLAN

Individual or all stored flight plans can be deleted from the G1000 memory.

Deleting a stored flight plan:

- 1) Press the **FPL** Key and turn the small **FMS** Knob to display the Flight Plan Catalog Page.
- 2) Press the **FMS** Knob to activate the cursor, and turn the **FMS** Knob to highlight the desired flight plan.
- 3) Press the **DELETE** Softkey; press the **CLR** Key; or press the **MENU** Key, highlight 'Delete Flight Plan', and press the **ENT** Key. The 'Delete Flight Plan XX?' window is displayed.
- 4) With 'OK' highlighted, press the **ENT** Key to delete the flight plan. To cancel the request, press the **CLR** Key, or highlight 'CANCEL' and press the **ENT** Key.



NOTE: The option to delete all stored flight plans is not available while the aircraft is in flight.

Deleting all stored flight plans:

- 1) Press the **FPL** Key and turn the small **FMS** Knob to display the Flight Plan Catalog Page.
- 2) Press the **MENU** Key.
- 3) Highlight 'Delete All' and press the **ENT** Key. A 'Delete all flight plans?' confirmation window is displayed.
- 4) With 'OK' highlighted, press the **ENT** Key to delete all flight plans. To cancel the request, press the **CLR** Key, or highlight 'CANCEL' and press the **ENT** Key.

FLIGHT PLAN EDITING

The active flight plan or any stored flight plan can be edited. The edits made to the active flight plan affect navigation as soon as they are entered.

DELETING THE ACTIVE FLIGHT PLAN

The G1000 allows deleting an active flight plan. Deleting the active flight plan suspends navigation by the G1000.

Deleting the active flight plan:

- 1) Press the **FPL** Key to display the Active Flight Plan Page (MFD) or the Active Flight Plan Window (PFD).
- 2) Press the **MENU** Key, highlight 'Delete Flight Plan', and press the **ENT** Key. The 'Delete all waypoints in flight plan?' window is displayed.
- 3) With 'OK' highlighted, press the **ENT** Key to delete the active flight plan. To cancel the request, press the **CLR** Key, or highlight 'CANCEL' and press the **ENT** Key.

DELETING FLIGHT PLAN ITEMS

Individual waypoints, entire airways, and entire procedures can be deleted from a flight plan. Some waypoints in the final approach segment (such as the FAF or MAP) can not be deleted individually. Attempting to delete a waypoint that is not allowed results in a window displaying 'Invalid flight plan modification.'

Deleting an individual waypoint from the active flight plan:

- 1) Press the **FPL** Key to display the Active Flight Plan Page (MFD) or the Active Flight Plan Window (PFD).
- 2) Press the **FMS** Knob to activate the cursor (not required on the PFD) and turn the large **FMS** Knob to highlight the waypoint to be deleted.
- 3) Press the **CLR** Key. The 'Remove XXXXX?' window is displayed.
- 4) With 'OK' highlighted, press the **ENT** Key. To cancel the request, press the **CLR** Key, or highlight 'CANCEL' and press the **ENT** Key.
- 5) Press the **FMS** Knob to remove the flashing cursor.

- SYSTEM OVERVIEW
- FLIGHT INSTRUMENTS
- EIS
- AUDIO PANEL & CNS
- FLIGHT MANAGEMENT
- HAZARD AVOIDANCE
- AFCS
- ADDITIONAL FEATURES
- APPENDICES
- INDEX

Deleting an entire airway from the active flight plan:

- 1) Press the **FPL** Key to display the Active Flight Plan Page (MFD) or the Active Flight Plan Window (PFD).
- 2) Press the **FMS** Knob to activate the cursor (not required on the PFD) and turn the large **FMS** Knob to highlight the white header of the airway to be deleted.
- 3) Press the **CLR** Key. The 'Remove <airway name>?' window is displayed.
- 4) With 'OK' highlighted, press the **ENT** Key. To cancel the request, press the **CLR** Key, or highlight 'CANCEL' and press the **ENT** Key.
- 5) Press the **FMS** Knob to remove the flashing cursor.

Deleting an entire procedure from the active flight plan:

- 1) Press the **FPL** Key to display the Active Flight Plan Page (MFD) or the Active Flight Plan Window (PFD).
- 2) Press the **FMS** Knob to activate the cursor (not required on the PFD) and turn the large **FMS** Knob to highlight the white header of the procedure to be deleted.
- 3) Press the **CLR** Key. The 'Remove <procedure name> from flight plan?' window is displayed.
- 4) With 'OK' highlighted, press the **ENT** Key. To cancel the request, press the **CLR** Key, or highlight 'CANCEL' and press the **ENT** Key.
- 5) Press the **FMS** Knob to remove the flashing cursor.

Or:

- 1) Press the **FPL** Key to display the Active Flight Plan Page (MFD) or the Active Flight Plan Window (PFD).
- 2) Press the **MENU** Key to display the Page Menu and turn the **FMS** Knob to highlight 'Remove <procedure>'.
3) Press the **ENT** Key. The 'Remove <procedure name> from flight plan?' window is displayed.
- 4) With 'OK' highlighted, press the **ENT** Key. To cancel the request, press the **CLR** Key, or highlight 'CANCEL' and press the **ENT** Key.

Deleting an individual waypoint from a stored flight plan:

- 1) Press the **FPL** Key to display the Active Flight Plan Page.
- 2) Turn the small **FMS** Knob clockwise one click to display the Flight Plan Catalog Page.
- 3) Press the **FMS** Knob to activate the cursor and turn the **FMS** Knob to highlight the flight plan to be edited.
- 4) Press the **EDIT** Softkey; or press the **MENU** Key, select 'Edit Flight Plan' and press the **ENT** Key. The Stored Flight Plan Page is displayed.
- 5) Turn the large **FMS** Knob to highlight the waypoint to be deleted.
- 6) Press the **CLR** Key. The 'Remove XXXXX?' window is displayed.
- 7) With 'OK' highlighted, press the **ENT** Key. To cancel the request, press the **CLR** Key, or highlight 'CANCEL' and press the **ENT** Key.
- 8) Press the **FMS** Knob to remove the flashing cursor.

Deleting an entire airway from a stored flight plan:

- 1) Press the **FPL** Key to display the Active Flight Plan Page.
- 2) Turn the small **FMS** Knob clockwise one click to display the Flight Plan Catalog Page.
- 3) Press the **FMS** Knob to activate the cursor and turn the **FMS** Knob to highlight the flight plan to be edited.
- 4) Press the **EDIT** Softkey; or press the **MENU** Key, select 'Edit Flight Plan' and press the **ENT** Key. The Stored Flight Plan Page is displayed.
- 5) Turn the large **FMS** Knob to highlight the white header of the airway to be deleted.
- 6) Press the **CLR** Key. The 'Remove <airway name>?' window is displayed.
- 7) With 'OK' highlighted, press the **ENT** Key. To cancel the request, press the **CLR** Key, or highlight 'CANCEL' and press the **ENT** Key.
- 8) Press the **FMS** Knob to remove the flashing cursor.

Deleting an entire procedure from a stored flight plan:

- 1) Press the **FPL** Key to display the Active Flight Plan Page.
- 2) Turn the small **FMS** Knob clockwise one click to display the Flight Plan Catalog Page.
- 3) Press the **FMS** Knob to activate the cursor and turn the **FMS** Knob to highlight the flight plan to be edited.
- 4) Press the **EDIT** Softkey; or press the **MENU** Key, select 'Edit Flight Plan' and press the **ENT** Key. The Stored Flight Plan Page is displayed.
- 5) Turn the large **FMS** Knob to highlight the white header of the procedure to be deleted.
- 6) Press the **CLR** Key. The 'Remove <procedure name> from flight plan?' window is displayed.
- 7) With 'OK' highlighted, press the **ENT** Key. To cancel the request, press the **CLR** Key, or highlight 'CANCEL' and press the **ENT** Key.
- 8) Press the **FMS** Knob to remove the flashing cursor.

Or:

- 1) Press the **FPL** Key to display the Active Flight Plan Page.
- 2) Turn the small **FMS** Knob clockwise one click to display the Flight Plan Catalog Page.
- 3) Press the **FMS** Knob to activate the cursor and turn the **FMS** Knob to highlight the flight plan to be edited.
- 4) Press the **EDIT** Softkey; or press the **MENU** Key, select 'Edit Flight Plan' and press the **ENT** Key. The Stored Flight Plan Page is displayed.
- 5) Press the **MENU** Key to display the Page Menu and turn the **FMS** Knob to highlight 'Remove <procedure>'.
- 6) Press the **ENT** Key. The 'Remove <procedure name> from flight plan?' window is displayed.
- 7) With 'OK' highlighted, press the **ENT** Key. To cancel the request, press the **CLR** Key, or highlight 'CANCEL' and press the **ENT** Key.
- 8) Press the **FMS** Knob to remove the flashing cursor.

- SYSTEM OVERVIEW
- FLIGHT INSTRUMENTS
- EIS
- AUDIO PANEL & CNS
- FLIGHT MANAGEMENT
- HAZARD AVOIDANCE
- AFCS
- ADDITIONAL FEATURES
- APPENDICES
- INDEX

CHANGING FLIGHT PLAN COMMENTS (NAMES)

The comment field (or name) of each flight plan can be changed to something that is useful for identification and sorting.

Changing the active flight plan comment:

- 1) Press the **FPL** Key to display the Active Flight Plan Page.
- 2) Press the **FMS** Knob to activate the cursor and turn the large **FMS** Knob to highlight the comment field.
- 3) Use the **FMS** Knobs to edit the comment.
- 4) Press the **ENT** Key to accept the changes.

Changing a stored flight plan comment:

- 1) Press the **FPL** Key to display the Active Flight Plan Page.
- 2) Turn the small **FMS** Knob clockwise one click to display the Flight Plan Catalog Page.
- 3) Press the **FMS** Knob to activate the cursor and turn the **FMS** Knob to highlight the flight plan to be edited.
- 4) Press the **EDIT** Softkey; or press the **MENU** Key, select 'Edit Flight Plan' and press the **ENT** Key. The Stored Flight Plan Page is displayed.
- 5) Turn the large **FMS** Knob to highlight the comment field.
- 6) Use the **FMS** Knobs to edit the comment.
- 7) Press the **ENT** Key to accept the changes.

ALONG TRACK OFFSETS

A waypoint having an “along track offset” distance from an existing waypoint can be entered into a flight plan. Along track offset waypoints lie along the path of the existing flight plan, and can be used to make the system reach a specified altitude before or after reaching the specified flight plan waypoint. Offset distances can be entered from 1 to 99 nm in increments of 1 nm. Entering a negative offset distance results in an along track offset waypoint inserted before the selected waypoint, whereas entering a positive offset distance results in an along track offset waypoint inserted after the selected waypoint. Multiple offset waypoints are allowed.

A waypoint must be adjacent to its parent waypoint in the flight plan, so the system limits the along-track distance to less than the length of the leg before or after the selected waypoint. If the selected waypoint is the active waypoint, the distance is limited to less than the distance to go to the active waypoint. Assigning an along track offset to a leg with indeterminate length is not permitted. An along track offset is not allowed at or after the final approach fix of an approach.

An along track offset distance cannot be modified once entered. If the along track offset distance must be changed, the existing along track offset waypoint must be deleted and a new one created with the new offset distance.

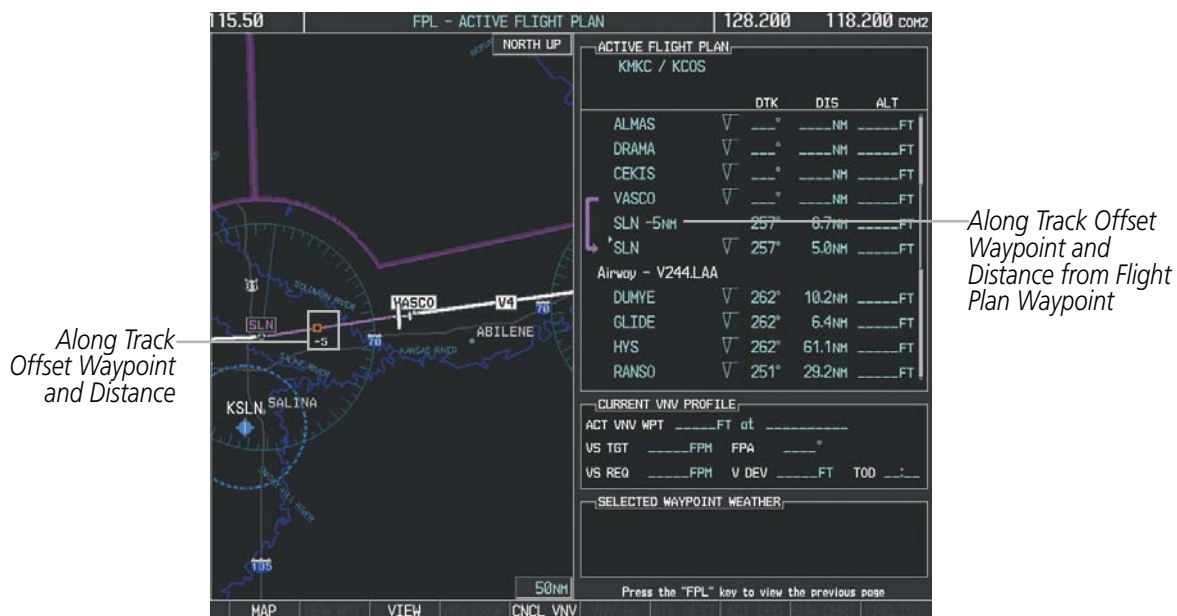

Figure 5-78 Along Track Offset

Entering an along track offset distance:

- 1) Press the **FPL** Key to display the Active Flight Plan Page (MFD) or the Active Flight Plan Window (PFD).
- 2) Press the **FMS** Knob to activate the cursor (not required on the PFD) and turn the large **FMS** Knob to highlight the waypoint for the along track offset.
- 3) Press the **ATK OFST** Softkey (MFD only); or press the **MENU** Key, highlight ‘Create ATK Offset Waypoint’, and press the **ENT** Key.
- 4) Enter a positive or negative offset distance in the range of +/- 1 to 99 nm (limited by leg distances).
- 5) Press the **ENT** Key to create the offset waypoint.
- 6) Press the **FMS** Knob to remove the flashing cursor.

PARALLEL TRACK

The Parallel Track (PTK) feature allows creation of a parallel course offset of 1 to 50 nm left or right of the current flight plan. When Parallel Track is activated, the course line drawn on the map pages shows the parallel course, and waypoint names have a lower case “p” placed after the identifier.

Using direct-to, loading an approach, a holding pattern, or editing and activating the flight plan automatically cancels Parallel Track. Parallel Track is also cancelled if a course change occurs greater than 120° or the parallel tracks overlap as a result of the course change.



NOTE: Vertical navigation is unavailable while the Parallel Track feature is active.

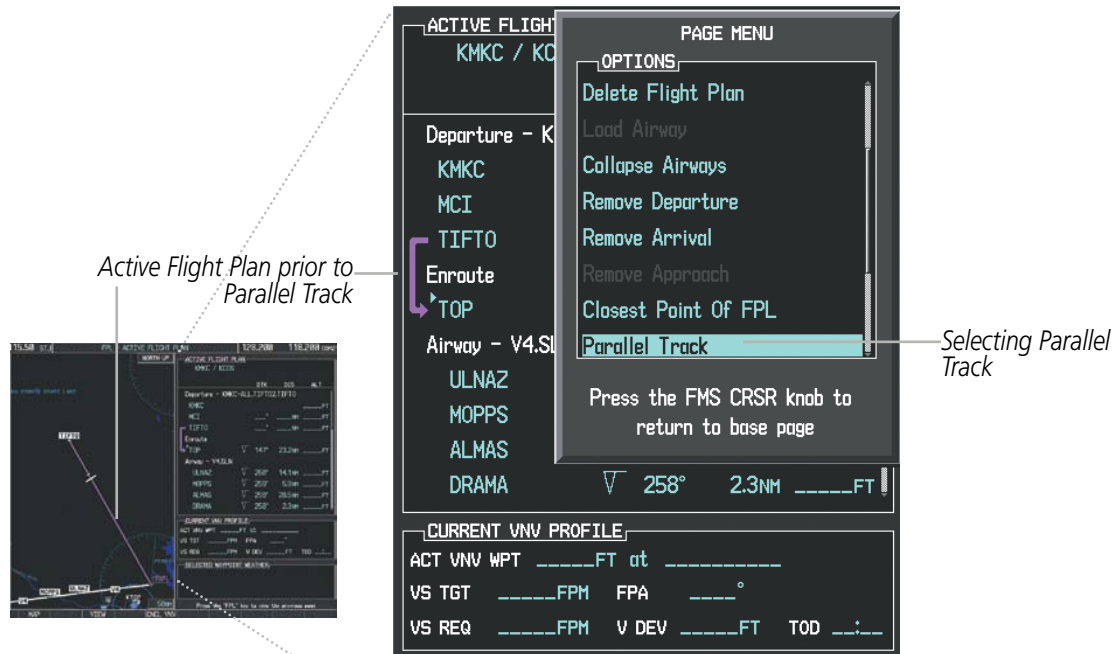

Figure 5-79 Active Flight Plan Window - Selecting Parallel Track

Activating parallel track:

- 1) Press the **FPL** Key to display the Active Flight Plan Page (MFD) or the Active Flight Plan Window (PF)
- 2) Press the **MENU** Key, highlight 'Parallel Track', and press the **ENT** Key. The Parallel Track Window is displayed with the direction field highlighted.
- 3) Turn the small **FMS** Knob to select 'Left' or 'Right' and press the **ENT** Key. The 'DISTANCE' field is highlighted.
- 4) Turn the small **FMS** Knob to enter a distance from 1-99 nm and press the **ENT** Key. 'ACTIVATE PARALLEL TRACK' is highlighted.
- 5) Press the **ENT** Key to activate parallel track. Press the **FMS** Knob or the **CLR** Key to cancel the parallel track activation.

- SYSTEM OVERVIEW
- FLIGHT INSTRUMENTS
- EIS
- AUDIO PANEL & CNS
- FLIGHT MANAGEMENT
- HAZARD AVOIDANCE
- AFCS
- ADDITIONAL FEATURES
- APPENDICES
- INDEX

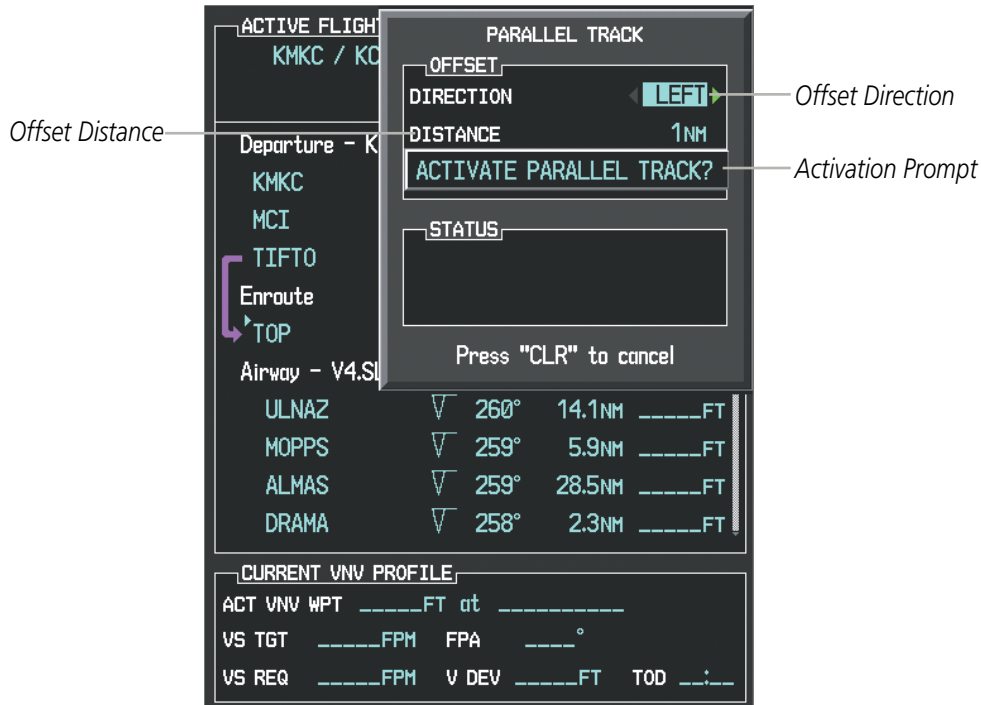

Figure 5-80 Parallel Track Window



Figure 5-81 Parallel Track Active

If the parallel track proposed by the offset direction and distance is not allowed by the system, the activation prompt is displayed, but disabled. Parallel Track cannot be activated if a course is set using direct-to or if the active leg is the first leg of the departure procedure. Attempting to activate parallel track with these conditions

results in the message 'Parallel Track Unavailable Invalid Route Geometry'. If an approach leg is active the status indicates that the system is unable to activate the parallel track with the message 'Parallel Track Unavailable Approach Leg Active'. If the offset direction and distance results in an unreasonable route geometry the status indicates that the system is unable to activate the parallel track because of invalid geometry.

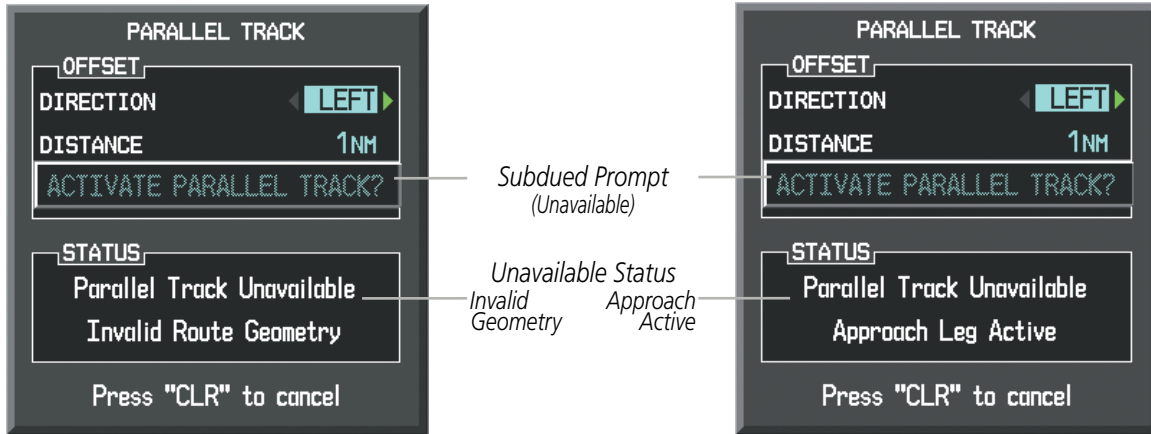

Figure 5-82 Parallel Track Unavailable

If the active leg is not a track between two fixes (TF) or a course to a fix (DF) leg, the status indicates that the system is unable to activate the parallel track because parallel track is not available for the active leg type.

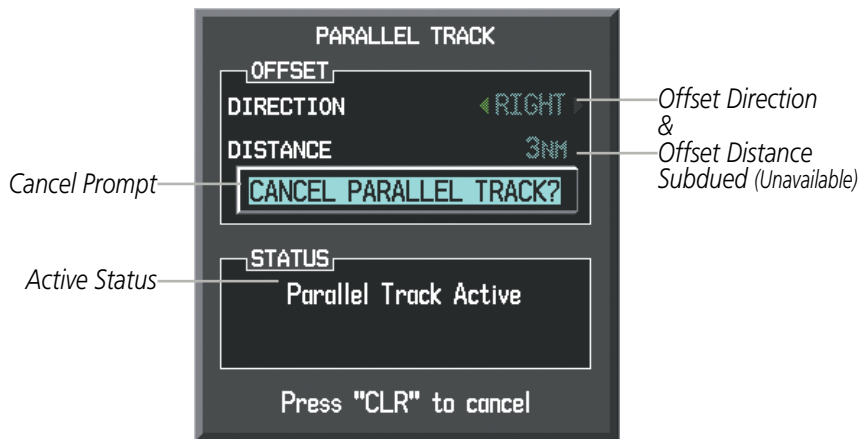

Figure 5-83 Cancelling Parallel Track

Cancelling parallel track:

- 1) Press the **FPL** Key to display the Active Flight Plan Page (MFD) or the Active Flight Plan Window (PFD)
- 2) Press the **MENU** Key, highlight 'Parallel Track', and press the **ENT** Key. The Parallel Track Window is displayed with 'CANCEL PARALLEL TRACK?' highlighted.
- 3) Press the **ENT** Key.

ACTIVATING A FLIGHT PLAN LEG

The G1000 allows selection of a highlighted leg as the “active leg” (the flight plan leg which is currently used for navigation guidance).

Activating a flight plan leg:

- 1) Press the **FPL** Key to display the Active Flight Plan Page (MFD) or the Active Flight Plan Window (PFD)
- 2) Press the **FMS** Knob to activate the cursor (not required on the PFD) and turn the large **FMS** Knob to highlight the destination waypoint for the desired leg.
- 3) Press the **ACT LEG** Softkey (MFD only); or press the **MENU** Key, highlight ‘Activate Leg’, and press the **ENT** Key. A confirmation window is displayed with ‘ACTIVATE’ highlighted.
- 4) Press the **ENT** Key to activate the flight plan leg. To cancel, press the **CLR** Key, or highlight ‘CANCEL’ and press the **ENT** Key.
- 5) Press the **FMS** Knob to remove the flashing cursor.

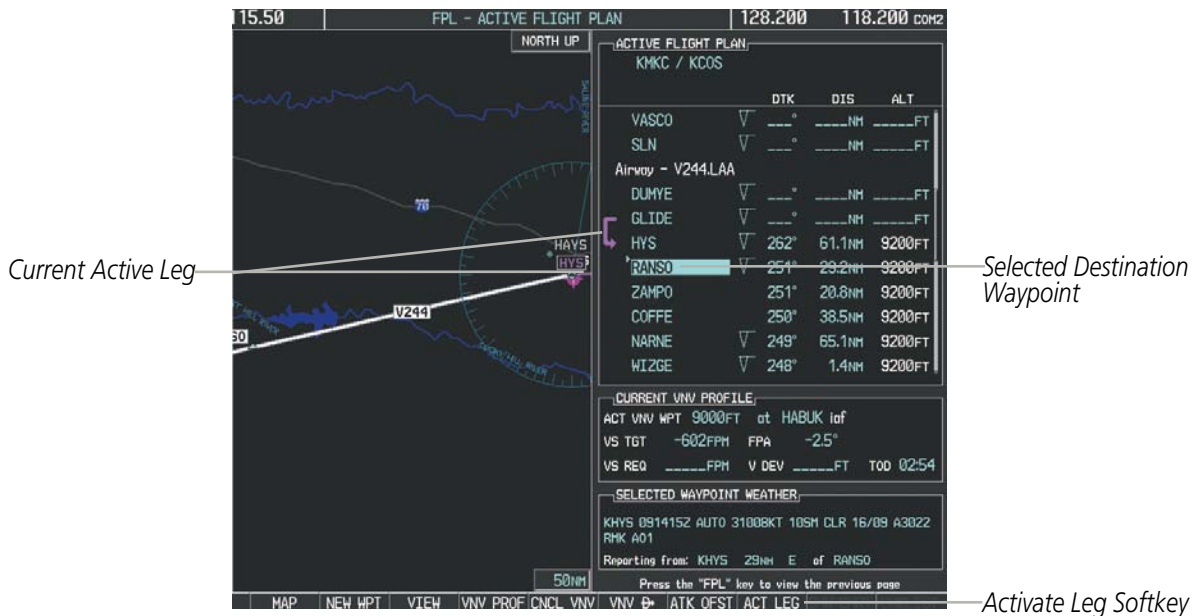

Figure 5-84 Active Flight Plan Page - Selecting the Leg Destination Waypoint



Confirmation Window

New Active Flight Plan Leg



Figure 5-85 Active Flight Plan Page - New Active Leg

INVERTING A FLIGHT PLAN

Any flight plan may be inverted (reversed) for navigation back to the original departure point.

Inverting the active flight plan:

- 1) Press the **FPL** Key to display the Active Flight Plan Page (MFD) or the Active Flight Plan Window (PFD)
- 2) Press the **MENU** Key, highlight 'Invert Flight Plan', and press the **ENT** Key. An 'Invert Active Flight Plan?' confirmation window is displayed.
- 3) Select 'OK'.
- 4) Press the **ENT** Key to invert and activate the active flight plan. To cancel, press the **CLR** Key, or highlight 'CANCEL' and press the **ENT** Key.

Inverting and activating a stored flight plan:

- 1) Press the **FPL** Key and turn the small **FMS** Knob to display the Flight Plan Catalog Page.
- 2) Press the **FMS** Knob to activate the cursor, and turn the **FMS** Knob to highlight the desired flight plan.
- 3) Press the **INVERT** Softkey; or press the **MENU** Key, highlight 'Invert & Activate FPL?', and press the **ENT** Key. The 'Invert and activate stored flight plan?' window is displayed.
- 4) With 'OK' highlighted, press the **ENT** Key. To cancel the request, press the **CLR** Key, or highlight 'CANCEL' and press the **ENT** Key.

FLIGHT PLAN VIEWS

Information about flight plans can be viewed in more than one way. The active flight plan can be configured to show cumulative distance over the length of the flight plan or the distance for each leg of the flight plan; and the active flight plan can be viewed in a narrow or wide view. In the wide view, additional information is displayed: Fuel Remaining (FUEL REM), Estimated Time Enroute (ETE), Estimated Time of Arrival (ETA), and Bearing to the waypoint (BRG).

Switching between leg-to-leg waypoint distance and cumulative waypoint distance:

- 1) Press the **FPL** Key on the MFD to display the Active Flight Plan Page.
- 2) Press the **VIEW** Softkey to display the **CUM** and **LEG-LEG** Softkeys.
- 3) Press the **CUM** Softkey to view cumulative waypoint distance, or press the **LEG-LEG** Softkey to view leg-to-leg waypoint distance.
- 4) Press the **BACK** Softkey to return to the top level active flight plan softkeys.

Active Flight Plan Leg to Leg Distance

Active Flight Plan Cumulative Distance



WIDE Softkey, NARROW Softkey, LEG-LEG Softkey, CUM Softkey

Figure 5-86 Active Flight Plan - Leg to Leg vs. Cumulative Distance

Switching between wide and narrow view:

- 1) Press the **FPL** Key on the MFD to display the Active Flight Plan Page.
- 2) Press the **VIEW** Softkey to display the **WIDE** and **NARROW** Softkeys.
- 3) Press the **WIDE** Softkey to display the wide view, or press the **NARROW** Softkey to display the narrow view.
- 4) Press the **BACK** Softkey to return to the top level active flight plan softkeys.

Active Flight Plan Leg to Leg Distance

Active Flight Plan Cumulative Distance



WIDE Softkey, NARROW Softkey, LEG-LEG Softkey, CUM Softkey

Figure 5-87 Active Flight Plan - Wide vs. Narrow View

COLLAPSING AIRWAYS

The G1000 allows airways on the active flight plan to be collapsed or expanded from the Active Flight Plan Page/Window. When airways have been collapsed, it is indicated on the airway heading.

When airways are collapsed, leg-to-leg computed values such as DIS or ETE shown for the exit waypoint reflect the total of all the legs on the airway that have been hidden in the collapsed display. The DTK value is inhibited because it is not usable in this context.

The Active Flight Plan Page always keeps the following three waypoints visible: “From” waypoint, “To” waypoint, and “Next” waypoint. To prevent one or more of these waypoints from being hidden in a collapsed airway segment, the airway segment that contains either the “To” or the “Next” waypoint is automatically expanded. When an airway is loaded, airways are automatically expanded to facilitate flight plan review.

- SYSTEM OVERVIEW
- FLIGHT INSTRUMENTS
- EIS
- AUDIO PANEL & CNS
- FLIGHT MANAGEMENT
- HAZARD AVOIDANCE
- AFCS
- ADDITIONAL FEATURES
- APPENDICES
- INDEX

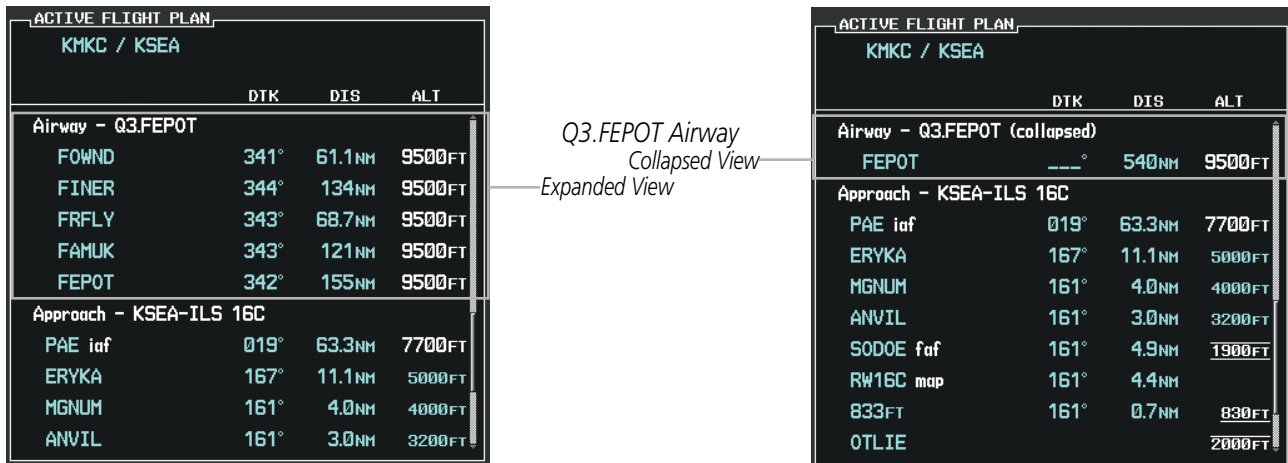

Figure 5-88 Expanded/Collapsed Airways

Collapsing/expanding the airways in the active flight plan:

- 1) Press the **FPL** Key to display the Active Flight Plan Page (MFD) or the Active Flight Plan Window (PFD).
- 2) Press the **MENU** Key, highlight 'Collapse Airways' or 'Expand Airways', and press the **ENT** Key. The airways are collapsed/expanded.

CLOSEST POINT OF FPL

'Closest Point of FPL' calculates the bearing and closest distance at which a flight plan passes a reference waypoint, and creates a new user waypoint along the flight plan at the location closest to a chosen reference waypoint.

Determining the closest point along the active flight plan to a selected waypoint:

- 1) Press the **FPL** Key to display the Active Flight Plan Page (MFD) or the Active Flight Plan Window (PFD).
- 2) Press the **MENU** Key, highlight 'Closest Point Of FPL', and press the **ENT** Key. A window appears with the reference waypoint field highlighted.
- 3) Enter the identifier of the reference waypoint and press the **ENT** Key. The G1000 displays the bearing (BRG) and distance (DIS) to the closest point along the flight plan to the selected reference waypoint and creates a user waypoint at this location. The name for the new user waypoint is derived from the identifier of the reference waypoint.

- SYSTEM OVERVIEW
- FLIGHT INSTRUMENTS
- EIS
- AUDIO PANEL & CNS
- FLIGHT MANAGEMENT
- HAZARD AVOIDANCE
- AFCS
- ADDITIONAL FEATURES
- APPENDICES
- INDEX

5.7 VERTICAL NAVIGATION



NOTE: The G1000 supports vertical navigation for all lateral leg types except for CA, CI, FA, FM, HA, HM, PI, VA, VD, VI, VR, and VM. Vertical constraints are not retained in stored flight plans.

The G1000 system Vertical Navigation (VNV) feature provides vertical profile guidance during the enroute and terminal phases of flight. Guidance based on specified altitudes at waypoints in the active flight plan or to a direct-to waypoint is provided. It includes vertical path guidance to a descending path, which is provided as a linear deviation from the desired path. The desired path is defined by a line joining two waypoints with specified altitudes or as a vertical angle from a specified waypoint/altitude. The vertical waypoints are integrated into the active flight plan. Both manual and autopilot-coupled guidance are supported.

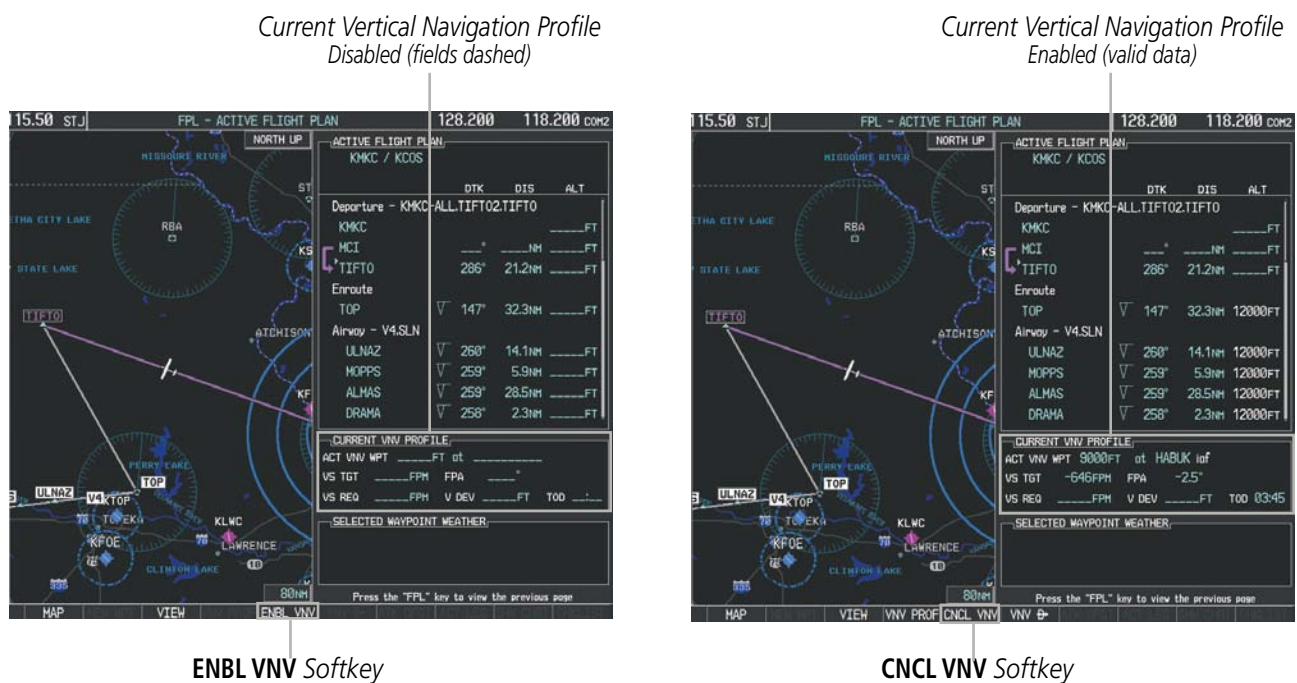

Figure 5-89 Enabling/Disabling Vertical Navigation

Enabling VNV guidance:

- 1) Press the **FPL** Key to display the Active Flight Plan Page on the MFD.
- 2) Press the **ENBL VNV** Softkey; or press the **MENU** Key, highlight 'Enable VNV', and press the **ENT** Key. Vertical navigation is enabled, and vertical guidance begins with the waypoint shown in the **CURRENT VNV PROFILE** box (defaults first waypoint in the active flight plan with an altitude enabled for vertical navigation (e.g., HABUK)).

Disabling VNV guidance:

- 1) Press the **FPL** Key to display the Active Flight Plan Page on the MFD.
- 2) Press the **CNCL VNV** Softkey; or press the **MENU** Key, highlight 'Cancel VNV', and press the **ENT** Key. Vertical navigation is disabled.

Canceling vertical navigation results in vertical deviation (V DEV), vertical speed required (VS REQ), and time to top of descent/bottom of descent (TIME TO TOD/BOD) going invalid. The Vertical Deviation Indicator (VDI) and Required Vertical Speed Indication (RVSI) on the PFD are removed, and the V DEV, VS REQ, and TIME TO TOD items displayed in the CURRENT VNV PROFILE box are dashed. VNV remains disabled until manually enabled. Vertical guidance in reversionary mode can only be enabled for a direct-to waypoint.

The G1000 allows a vertical navigation direct-to to any waypoint in the active flight plan with an altitude constraint “designated” for vertical guidance. Pressing the **VNV Direct-to** Softkey on the Active Flight Plan Page allows the flight plan to be flown, while vertical guidance based on the altitude constraint at the VNV direct-to waypoint is provided. The altitude change begins immediately and is spread along the flight plan from current position to the vertical direct-to waypoint, not just along the leg for the direct-to waypoint. A direct-to with altitude constraint activated by pressing the **Direct-to** Key also provides vertical guidance, but would bypass flight plan waypoints between the current position in the flight plan and the direct-to waypoint. A top of descent (TOD) point is computed based on the default flight path angle; descent begins once the TOD is reached.

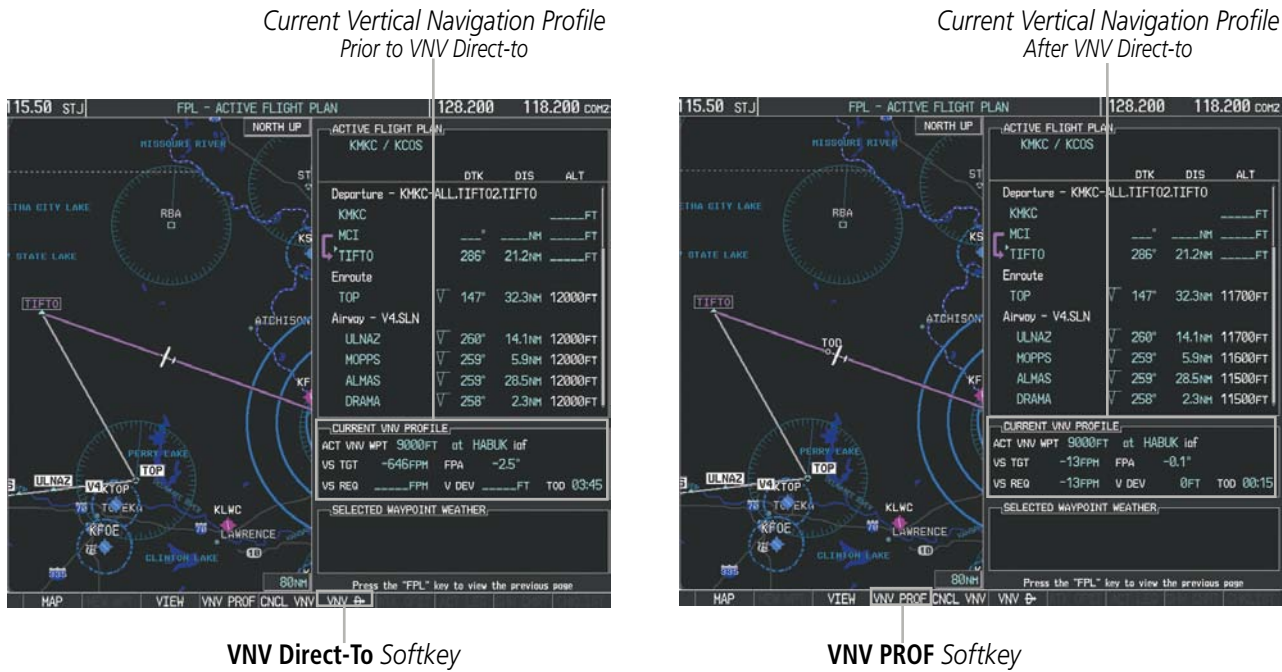

Figure 5-90 Vertical Navigation Direct-To

Activating a vertical navigation direct-to:

- 1) Press the **FPL** Key to display the Active Flight Plan Page on the MFD.
- 2) Press the **FMS** Knob to activate the cursor and turn the **FMS** Knob to highlight the desired waypoint.



NOTE: The selected waypoint must have a designated altitude constraint (light blue number) to be used. If not, the first waypoint in the flight plan with a designated altitude constraint is selected.

- 3) Select the **VNV Direct-To** Softkey; or press the **MENU** Key, highlight 'VNV Direct-To', and press the **ENT** Key. An 'Activate vertical Direct-to to: NNNNNFT at XXXXXX?' confirmation window is displayed.

- 4) Press the **ENT** Key. Vertical guidance begins to the altitude constraint for the selected waypoint.
- 5) Press the **FMS** Knob to remove the flashing cursor.

The vertical navigation profile can be modified by directly entering a vertical speed target (VS TGT) and/or flight path angle (FPA) in the CURRENT VNV PROFILE box.

Modifying the VS TGT and FPA:

- 1) Press the **FPL** Key to display the Active Flight Plan Page on the MFD.
- 2) Press the **VNV PROF** Softkey; or press the **MENU** Key, highlight 'Select VNV Profile Window', and press the **ENT** Key. The cursor is now located in the CURRENT VNV PROFILE box without having to scroll all the way through past the end of the active flight plan.
- 3) Turn the **FMS** Knobs as needed to edit the values.
- 4) Press the **FMS** Knob to remove the flashing cursor.

ALTITUDE CONSTRAINTS

The G1000 system can use altitude constraints associated with lateral waypoints to give guidance for vertical navigation. These altitudes are, depending on the specific instance, manually entered or retrieved from the published altitudes in the navigation database. The navigation database only contains altitudes for procedures that call for "Cross at" altitudes. If the procedure states "Expect to cross at," then the altitude is not in the database. In this case the altitude may be entered manually.

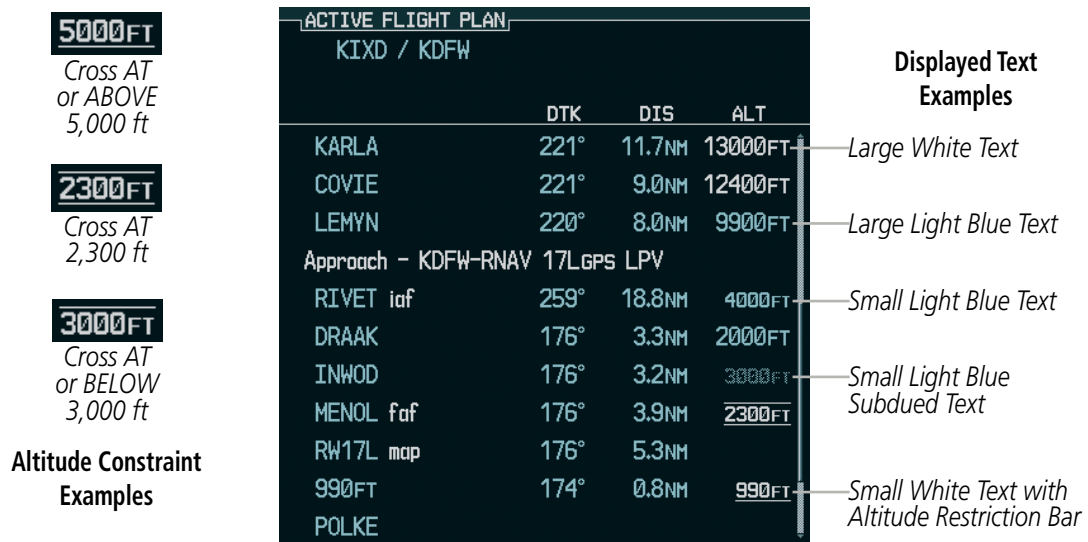

Figure 5-91 Waypoint Altitude Constraints

	White Text	Light Blue Text	Light Blue Subdued Text
Large Text	Altitude calculated by the system estimating the altitude of the aircraft as it passes over the navigation point. This altitude is provided as a reference and is not designated to be used in determining vertical speed and deviation guidance.	Altitude has been entered manually. Altitude is designated for use in giving vertical speed and deviation guidance. Altitude does not match the published altitude in navigation database or no published altitude exists.	The system cannot use this altitude in determining vertical speed and deviation guidance because of an invalid constraint condition.
Small Text	Altitude is not designated to be used in determining vertical speed and deviation guidance. Altitude has been retrieved from the navigation database and is provided as a reference.	Altitude is designated for use in giving vertical speed and deviation guidance. Altitude has been retrieved from the navigation database or has been entered manually and matches a published altitude in the navigation database.	The system cannot use this altitude in determining vertical speed and deviation guidance because of an invalid constraint condition.

Table 5-8 Altitude Constraint Size and Color Coding

Altitudes associated with approach procedures are “auto-designated”. This means the system automatically uses the altitudes loaded with the approach for giving vertical speed and deviation guidance. Note that these altitudes are displayed as blue text up to, but not including, the FAF. The FAF is always a “reference only” altitude and cannot be designated, unless the selected approach does not provide vertical guidance. In this case, the FAF altitude can be designated.

Altitudes that have been designated for use in vertical guidance can be “un-designated” using the **CLR** Key. The altitude is now displayed only as a reference. It is not used to give vertical guidance. Other displayed altitudes may change due to re-calculations or be rendered invalid as a result of manually changing an altitude to a non-designated altitude.

Designating a waypoint altitude to be used for vertical guidance:

- 1) Press the **FPL** Key to display the Active Flight Plan Page on the MFD.
- 2) Press the **FMS** Knob, and turn to highlight the desired waypoint altitude.
- 3) Turn the small **FMS** Knob to enter editing mode.
- 4) Press the **ENT** Key. The altitude is now shown in blue, indicating it is usable for vertical guidance.

Designating a procedure waypoint altitude to be used for vertical guidance:

- 1) Press the **FPL** Key to display the Active Flight Plan Page on the MFD.
- 2) Press the **FMS** Knob, and turn to highlight the desired waypoint altitude.
- 3) Press the **ENT** Key. The altitude is now shown in blue, indicating it is usable for vertical guidance.

Altitude constraints are displayed and entered in feet mean sea level (MSL) values to the nearest hundred. An altitude constraint in feet above ground level (AGL) format is supported for airports. When a database altitude restriction is displayed, the G1000 allows entry of a different altitude when creating a waypoint, effectively overriding the database restriction (only before the FAF). When a database altitude restriction of type “AT or ABOVE” or “AT or BELOW” is activated, the system uses the “AT” portion of the restriction to define the vertical profile.

- SYSTEM OVERVIEW
- FLIGHT INSTRUMENTS
- EIS
- AUDIO PANEL & CNS
- FLIGHT MANAGEMENT
- HAZARD AVOIDANCE
- AFCS
- ADDITIONAL FEATURES
- APPENDICES
- INDEX

An altitude constraint is invalid if:

- Meeting the constraint requires the aircraft to climb
- Meeting the constraint requires the maximum flight path angle (6° down) or maximum vertical speed (-6000 fpm) to be exceeded
- The altitude constraint results in a TOD behind the aircraft present position
- The constraint is within a leg type for which altitude constraints are not supported
- The altitude constraint is added to the FAF of an approach that provides vertical guidance (i.e., ILS or GPS SBAS approach)
- The altitude constraint is added to a waypoint past the FAF.

Entering/modifying an altitude constraint:

- 1) Press the **FPL** Key to display the Active Flight Plan Page on the MFD.
- 2) Press the **FMS** Knob, and turn to highlight the desired waypoint altitude constraint.
- 3) Enter an altitude constraint value using the **FMS** Knobs. To enter altitudes as a flight level, turn the small **FMS** Knob counter-clockwise past zero or clockwise past 9 on the first character, and the system automatically changes to show units of Flight Level. Turn the large **FMS** Knob clockwise to highlight the first zero and enter the three digit flight level.
- 4) Press the **ENT** Key to accept the altitude constraint; if the selected waypoint is an airport, an additional choice is displayed. Turn the small **FMS** Knob to choose 'MSL' or 'AGL', and press the **ENT** Key to accept the altitude.

Altitude constraints can be modified or deleted after having been added to the flight plan. In the event an altitude constraint is deleted and the navigation database contains an altitude restriction for the lateral waypoint, the G1000 displays the altitude restriction from the database provided no predicted altitude can be provided. The G1000 also provides a way to reinstate a published altitude constraint that has been edited.

Deleting an altitude constraint provided by the navigation database:

- 1) Press the **FPL** Key to display the Active Flight Plan Page on the MFD.
- 2) Press the **FMS** Knob, and turn to highlight the desired waypoint altitude constraint.
- 3) Press the **CLR** Key. A 'Remove VNV altitude constraint?' confirmation window is displayed.
- 4) Select 'OK' and press the **ENT** Key.

Deleting an altitude constraint that has been manually entered:

- 1) Press the **FPL** Key to display the Active Flight Plan Page on the MFD.
- 2) Press the **FMS** Knob, and turn to highlight the desired waypoint altitude constraint.
- 3) Press the **CLR** Key. A 'Remove or Revert to published VNV altitude of nnnnnFT?' confirmation window is displayed.
- 4) Select 'REMOVE' and press the **ENT** Key. The manually entered altitude is deleted (it is replaced by a system calculated altitude, if available).

Reverting a manually entered altitude constraint back to the navigation database value:

- 1) Press the **FPL** Key to display the Active Flight Plan Page on the MFD.
- 2) Press the **FMS** Knob, and turn to highlight the desired waypoint altitude constraint.
- 3) Press the **CLR** Key. A 'Remove or Revert to published VNV altitude of nnnnnFT?' confirmation window is displayed.
- 4) Select 'REVERT' and press the **ENT** Key. The altitude is changed to the navigation database value.
- 5) Press the **FMS** Knob to remove the flashing cursor.

Modifying a system calculated altitude constraint:

- 1) Press the **FPL** Key to display the Active Flight Plan Page on the MFD.
- 2) Press the **FMS** Knob, and turn to highlight the desired waypoint altitude constraint.
- 3) Press the **CLR** Key. An 'Edit or Revert to published VNV altitude of nnnnnFT?' confirmation window is displayed.
- 4) Select 'EDIT' and press the **ENT** Key.
- 5) Edit the value using the **FMS** Knobs, and press the **ENT** Key.
- 6) Press the **FMS** Knob to remove the flashing cursor.

5.8 PROCEDURES

The G1000 can access the whole range of instrument procedures available. Departures (DPs), arrivals (STARs), and non-precision and precision approaches (APPRs) are stored within the database and can be loaded using the Procedures (**PROC**) Key.

The selected procedure for the departure or arrival airport is added to the active flight plan. No waypoints are required to be in the active flight plan to load procedures; however, if the departure and arrival airport are already loaded, the procedure loading window defaults to the appropriate airport, saving some time selecting the correct airport on the Procedure Loading Page. Whenever an approach is selected, the choice to either “load” or “activate” is given. “Loading” adds the approach to the end of the flight plan without immediately using it for navigation guidance. This allows continued navigation via the intermediate waypoints in the original flight plan, but keeps the procedure available on the Active Flight Plan Page for quick activation when needed. “Activating” also adds the procedure to the end of the flight plan but immediately begins to provide guidance to the first waypoint in the approach.

DEPARTURES

A Departure Procedure (DP) is loaded at the departure airport in the flight plan. Only one departure can be loaded at a time in a flight plan. If a departure is loaded when another departure is already in the active flight plan, the new departure replaces the previous departure. The route is defined by selection of a departure, the transition waypoints, and a runway.

LOADING A DEPARTURE INTO THE ACTIVE FLIGHT PLAN

Loading a departure into the active flight plan using the **PROC** Key:

- 1) Press the **PROC** Key. The Procedures Window is displayed.
- 2) Highlight ‘SELECT DEPARTURE’.
- 3) Press the **ENT** Key. The Departure Loading Page is displayed.
- 4) Use the **FMS** Knob to select an airport and press the **ENT** Key.
- 5) Select a departure from the list and press the **ENT** Key.
- 6) Select a runway (if required) and press the **ENT** Key.
- 7) Select a transition (if required) and press the **ENT** Key. ‘LOAD?’ is highlighted.
- 8) Press the **ENT** Key to load the departure procedure.

SYSTEM OVERVIEW
 FLIGHT INSTRUMENTS
 EIS
 AUDIO PANEL & CNS
 FLIGHT MANAGEMENT
 HAZARD AVOIDANCE
 AFCS
 ADDITIONAL FEATURES
 APPENDICES
 INDEX

Available Procedure Actions

Departure Airport



Loaded Procedures

Departure Preview

Departure Choices

Figure 5-92 Departure Selection

Selected Departure

Loaded Departure



Procedure Loading Page Selection Softkeys

Figure 5-93 Departure Loading

Viewing available departures at an airport:

- 1) From the Airport Information Page (first page in the WPT group), press the **DP** Softkey. The Departure Information Page is displayed, defaulting to the airport displayed on the Airport information Page.
- 2) To select another airport, press the **FMS** Knob to activate the cursor, enter an identifier/facility name/city, and press the **ENT** Key.
- 3) Turn the large **FMS** Knob to highlight the Departure. The departure is previewed on the map.
- 4) Turn the small **FMS** Knob to view the available departures. Press the **ENT** Key to select the departure. The cursor moves to the Runway box. The departure is previewed on the map.
- 5) Turn the small **FMS** Knob to view the available runways. Press the **ENT** Key to select the runway. The cursor moves to the Transition box (only if there are available transitions). The departure is previewed on the map.
- 6) Turn the small **FMS** Knob to view the available transitions. Press the **ENT** Key to select the transition. The cursor moves to the Sequence box. The departure is previewed on the map.
- 7) Press the **INFO-x** Softkey to return to the Airport Information Page.

REMOVING A DEPARTURE FROM THE ACTIVE FLIGHT PLAN

When plans change while flying IFR, departures can be easily removed from the Active Flight Plan.

Removing a departure procedure from the active flight plan:

- 1) Press the **FPL** Key to display the Active Flight Plan Page (MFD) or the Active Flight Plan Window (PFD)
- 2) Press the **MENU** Key, and highlight 'Remove Departure'.
- 3) Press the **ENT** Key. A confirmation window is displayed listing the departure procedure.
- 4) With 'OK' highlighted, press the **ENT** Key. To cancel the removal request, highlight 'CANCEL' and press the **ENT** Key.

Or:

- 1) Press the **FPL** Key to display the Active Flight Plan Page (MFD) or the Active Flight Plan Window (PFD)
- 2) Press the **FMS** Knob, and turn to highlight the departure header in the active flight plan.
- 3) Press the **CLR** Key. A confirmation window is displayed listing the departure procedure.
- 4) With 'OK' highlighted, press the **ENT** Key. To cancel the removal request, highlight 'CANCEL' and press the **ENT** Key.
- 5) Press the **FMS** Knob to remove the flashing cursor.

ARRIVALS

A Standard Terminal Arrival (STAR) can be loaded at any airport that has one available. Only one arrival can be loaded at a time in a flight plan. If an arrival is loaded when another arrival is already in the active flight plan, the new arrival replaces the previous arrival. The route is defined by selection of an arrival, the transition waypoints, and a runway.

LOADING AN ARRIVAL INTO THE ACTIVE FLIGHT PLAN

Loading an arrival into the active flight plan using the PROC Key:

- 1) Press the **PROC** Key. The Procedures Window is displayed.
- 2) Highlight 'SELECT ARRIVAL'.
- 3) Press the **ENT** Key. The Arrival Loading Page is displayed.
- 4) Use the **FMS** Knob to select an airport and press the **ENT** Key.
- 5) Select an arrival from the list and press the **ENT** Key.
- 6) Select a transition (if required) and press the **ENT** Key.
- 7) Select a runway (if required) and press the **ENT** Key. 'LOAD?' is highlighted.
- 8) Press the **ENT** Key to load the arrival procedure.

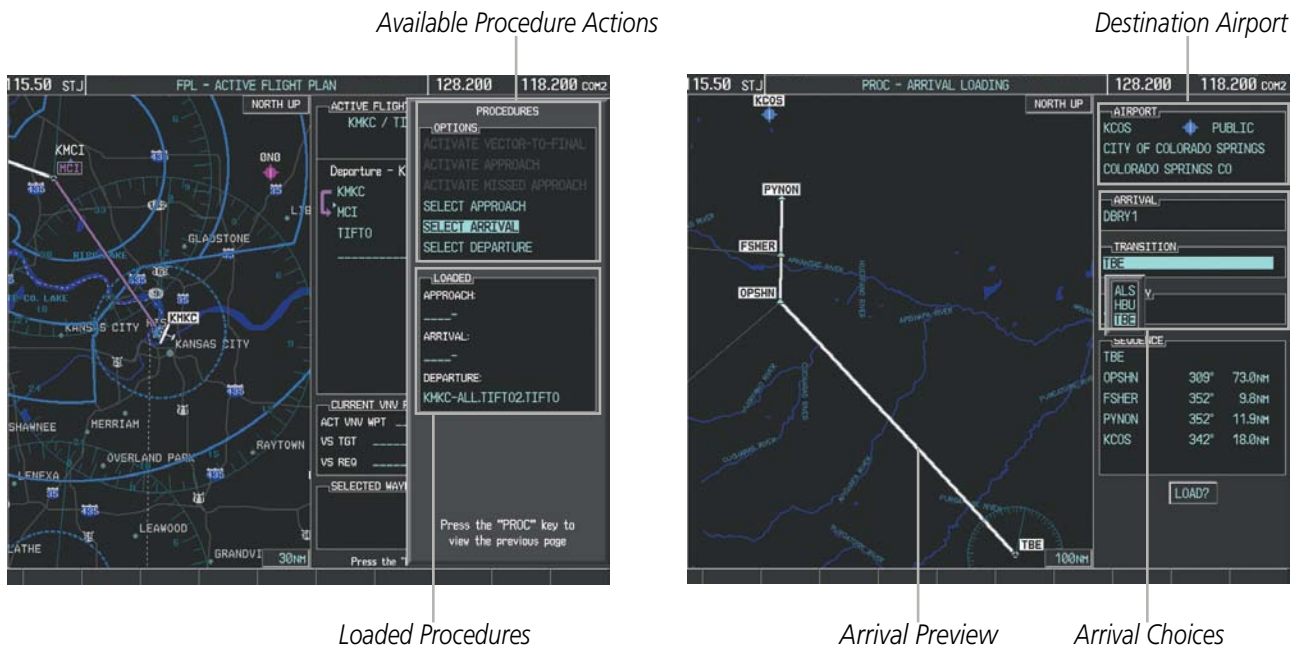

Figure 5-94 Arrival Selection



Procedure Loading Page Selection Softkeys

Figure 5-95 Arrival Loading

Viewing available arrivals at an airport:

- 1) From the Airport Information Page (first page in the WPT group), press the **STAR** Softkey. The Arrival Information Page is displayed, defaulting to the airport displayed on the Airport Information Page.
- 2) To select another airport, press the **FMS** Knob to activate the cursor, enter an identifier/facility name/city, and press the **ENT** Key.
- 3) Turn the large **FMS** Knob to highlight the Arrival. The arrival is previewed on the map.
- 4) Turn the small **FMS** Knob to view the available arrivals. Press the **ENT** Key to select the arrival. The cursor moves to the Transition box. The arrival is previewed on the map.
- 5) Turn the small **FMS** Knob to view the available transitions. Press the **ENT** Key to select the transition. The cursor moves to the Runway box. The arrival is previewed on the map.
- 6) Turn the small **FMS** Knob to view the available runways. Press the **ENT** Key to select the runway. The cursor moves to the Sequence box. The arrival is previewed on the map.
- 7) Press the **INFO-x** Softkey to return to the Airport Information Page.

REMOVING AN ARRIVAL FROM THE ACTIVE FLIGHT PLAN

When plans change while flying IFR, arrivals can be easily removed from the Active Flight Plan.

Removing an arrival from the active flight plan:

- 1) Press the **FPL** Key to display the Active Flight Plan Page (MFD) or the Active Flight Plan Window (PFD)
- 2) Press the **MENU** Key, and highlight 'Remove Arrival'.

- 3) Press the **ENT** Key. A confirmation window is displayed listing the arrival procedure.
- 4) With 'OK' highlighted, press the **ENT** Key. To cancel the removal request, highlight 'CANCEL' and press the **ENT** Key.

Or:

- 1) Press the **FPL** Key to display the Active Flight Plan Page (MFD) or the Active Flight Plan Window (PFD)
- 2) Press the **FMS** Knob, and turn to highlight the arrival header in the active flight plan.
- 3) Press the **CLR** Key. A confirmation window is displayed listing the arrival procedure.
- 4) With 'OK' highlighted, press the **ENT** Key. To cancel the removal request, highlight 'CANCEL' and press the **ENT** Key.
- 5) Press the **FMS** Knob to remove the flashing cursor.

APPROACHES



NOTE: *If certain GPS parameters (SBAS, RAIM, etc.) are not available, some published approach procedures for the desired airport may not be displayed in the list of available approaches.*

An Approach Procedure (APPR) can be loaded at any airport that has one available, and provides guidance for non-precision and precision approaches to airports with published instrument approach procedures. Only one approach can be loaded at a time in a flight plan. If an approach is loaded when another approach is already in the active flight plan, the new approach replaces the previous approach. The route is defined by selection of an approach and the transition waypoints.

Whenever an approach is selected, the choice to either “load” or “activate” is given. “Loading” adds the approach to the end of the flight plan without immediately using it for navigation guidance. This allows continued navigation via the intermediate waypoints in the original flight plan, but keeps the procedure available on the Active Flight Plan Page for quick activation when needed. “Activating” also adds the procedure to the end of the flight plan but immediately begins to provide guidance to the first waypoint in the approach.

When selecting an approach, a “GPS” designation to the right of the procedure name indicates the procedure can be flown using the GPS receiver. Some procedures do not have this designation, meaning the GPS receiver can be used for supplemental navigation guidance only. If the GPS receiver cannot be used for primary guidance, the appropriate navigation receiver must be used for the selected approach (e.g., VOR or ILS). The final course segment of ILS approaches, for example, must be flown by tuning the NAV receiver to the proper frequency and selecting that NAV receiver on the CDI.

The G1000 SBAS GPS allows for flying LNAV, LNAV/VNAV, and LPV approaches according to the published chart. LNAV+V is a standard LNAV approach with advisory vertical guidance provided for assistance in maintaining a constant vertical glidepath similar to an ILS glideslope on approach. This guidance is displayed on the G1000 PFD in the same location as the ILS glideslope using a magenta diamond. In all cases where LNAV+V is indicated by the system during an approach, LNAV minima are used. The active approach type is annunciated on the HSI as shown in the following table:

HSI Annunciation	Description	Example on HSI
LNAV	GPS approach using published LNAV minima	 <p>Approach Type</p> <ul style="list-style-type: none"> - LNAV - LNAV+V - L/VNAV - LPV
LNAV+V	GPS approach using published LNAV minima. Advisory vertical guidance is provided	
L/VNAV (available only if SBAS equipped)	GPS approach using published LNAV/VNAV minima	
LPV (available only if SBAS equipped)	GPS approach using published LPV minima	

Table 5-9 Approach Types

LOADING AN APPROACH INTO THE ACTIVE FLIGHT PLAN

Loading an approach into the active flight plan using the PROC Key:

- 1) Press the **PROC** Key. The Procedures Window is displayed.
- 2) Highlight 'SELECT APPROACH', and press the **ENT** Key. The Approach Loading Page is displayed.
- 3) Use the **FMS** Knob to select an airport and press the **ENT** Key.
- 4) Select an approach from the list and press the **ENT** Key.
- 5) Select a transition (if required) and press the **ENT** Key.
- 6) Barometric Minimums
 - a) To set 'MINIMUMS', turn the small **FMS** Knob to select 'BARO', and press the **ENT** Key. Turn the small **FMS** Knob to select the altitude, and press the **ENT** Key.
 - Or:
 - b) To skip setting minimums, press the **ENT** Key.
- 7) Press the **ENT** Key with 'LOAD?' highlighted to load the approach procedure; or turn the large **FMS** Knob to highlight 'ACTIVATE' and press the **ENT** Key to load and activate the approach procedure.



NOTE: When GPS is not approved for the selected final approach course, the message 'NOT APPROVED FOR GPS' is displayed. GPS provides guidance to the approach, but the HSI must be switched to a NAV receiver to fly the final course of the approach.

SYSTEM OVERVIEW
 FLIGHT INSTRUMENTS
 EIS
 AUDIO PANEL & CNS
 FLIGHT MANAGEMENT
 HAZARD AVOIDANCE
 AFCS
 ADDITIONAL FEATURES
 APPENDICES
 INDEX

Available Procedure Actions

Destination Airport

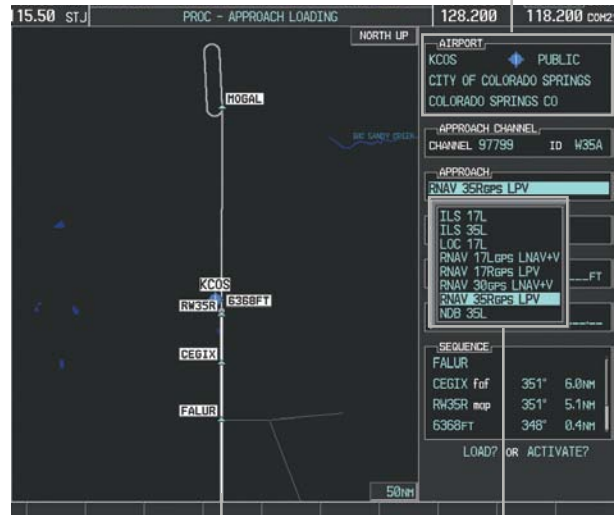

Loaded Procedures

Approach Preview

Approach Choices

Figure 5-96 Approach Selection

Selected Approach

Loaded Approach

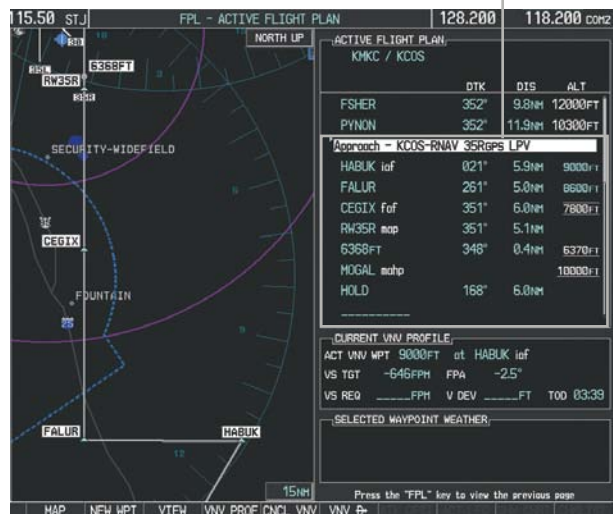

Procedure Loading Page Selection Softkeys

Figure 5-97 Approach Loading

Viewing available approaches at an airport:

- 1) From the Airport Information Page (first page in the WPT group), press the **APR** Softkey. The Approach Information Page is displayed, defaulting to the airport displayed on the Airport information Page.
- 2) To select another airport, press the **FMS** Knob to activate the cursor, enter an identifier/facility name/city, and press the **ENT** Key.

- 3) Press the **FMS** Knob, then turn the large **FMS** Knob to highlight the Approach. The approach is previewed on the map.
- 4) Turn the small **FMS** Knob to view the available approaches. Press the **ENT** Key to select the approach. The cursor moves to the Transition box. The approach is previewed on the map.
- 5) Turn the small **FMS** Knob to view the available transitions. Press the **ENT** Key to select the transition. The cursor moves to the Minimums box. The approach is previewed on the map.
- 6) Turn the small **FMS** Knob to select BARO (or optional RAD ALT) minimums on or off. Press the **ENT** Key.
 - a) When minimums are selected on, the cursor moves to the minimum altitude field. Use the small FMS Knob to select the altitude. Press the **ENT** Key. The cursor moves to the Sequence box. The approach is previewed on the map.
Or:
 - b) When minimums are selected off, the cursor moves to the Sequence box. The approach is previewed on the map.
- 7) Press the **INFO-x** Softkey to return to the Airport Information Page.

Loading an approach into the active flight plan from the Nearest Airport Page:

- 1) Select the Nearest Airports Page.
- 2) Press the **FMS** Knob, then turn the large **FMS** Knob to highlight the desired nearest airport. The airport is previewed on the map.
- 3) Press the **APR** Softkey; or press the **MENU** Key, highlight 'Select Approach Window', and press the **ENT** Key.
- 4) Turn the **FMS** Knob to highlight the desired approach.
- 5) Press the **LD APR** Softkey; or press the **MENU** Key, highlight 'Load Approach', and press the **ENT** Key. The Approach Loading Page is displayed with the transitions field highlighted.
- 6) Turn the **FMS** Knob to highlight the desired transition, and press the **ENT** Key.
- 7) Barometric Minimums
 - a) To set 'MINIMUMS', turn the small **FMS** Knob to select 'BARO', and press the **ENT** Key. Turn the small **FMS** Knob to select the altitude, and press the **ENT** Key. The 'LOAD?' field is highlighted.
Or:
 - b) To skip setting minimums, press the **ENT** Key. The 'LOAD?' field is highlighted.
- 8) Press the **ENT** Key with 'LOAD?' highlighted to load the approach procedure; or turn the large **FMS** Knob to highlight 'ACTIVATE' and press the **ENT** Key to load and activate the approach procedure. The G1000 continues navigating the current flight plan until the approach is activated. When GPS is not approved for the selected final approach course, the message 'NOT APPROVED FOR GPS' is displayed. GPS provides guidance to the approach, but the HSI must be switched to a NAV receiver to fly the final course of the approach.

ACTIVATING AN APPROACH

A previously loaded approach can be activated from the Procedures Window.

Activating a previously loaded approach:

- 1) Press the **PROC** Key. The Procedures Window is displayed with 'Activate Approach' highlighted.
- 2) Press the **ENT** Key to activate the approach.

In many cases, it may be easiest to “load” the full approach while still some distance away, enroute to the destination airport. Later, if vectored to final, use the steps above to select 'Activate Vector-To-Final' — which makes the inbound course to the FAF waypoint active.

Activating a previously loaded approach with vectors to final:

- 1) Press the **PROC** Key to display the Procedures Window.
- 2) Highlight 'ACTIVATE VECTOR-TO-FINAL' and press the **ENT** Key.

Loading and activating an approach using the MENU Key:

- 1) From the Approach Loading Page, press the **MENU** Key. The page menu is displayed with 'Load & Activate Approach' highlighted.
- 2) Press the **ENT** Key. When GPS is not approved for the selected final approach course, the message 'NOT APPROVED FOR GPS' is displayed. GPS provides guidance to the approach, but the HSI must to be switched to a NAV receiver to fly the final course of the approach.

REMOVING AN APPROACH FROM THE ACTIVE FLIGHT PLAN

When plans change while flying IFR, approaches can be easily removed from the Active Flight Plan.

Removing an approach from the active flight plan:

- 1) Press the **FPL** Key to display the Active Flight Plan Page (MFD) or the Active Flight Plan Window (PFD)
- 2) Press the **MENU** Key, and highlight 'Remove Approach'.
- 3) Press the **ENT** Key. A confirmation window is displayed listing the approach procedure.
- 4) With 'OK' highlighted, press the **ENT** Key. To cancel the removal, highlight 'CANCEL' and press the **ENT** Key.

Or:

- 1) Press the **FPL** Key to display the Active Flight Plan Page (MFD) or the Active Flight Plan Window (PFD)
- 2) Press the **FMS** Knob, and turn to highlight the approach header in the active flight plan.
- 3) Press the **CLR** Key. A confirmation window is displayed listing the approach procedure.
- 4) With 'OK' highlighted, press the **ENT** Key. To cancel the removal, highlight 'CANCEL' and press the **ENT** Key.
- 5) Press the **FMS** Knob to remove the flashing cursor.

MISSED APPROACH

Activating a missed approach in the active flight plan:

- 1) Press the **PROC** Key.
- 2) Turn the **FMS** Knob to highlight 'ACTIVATE MISSED APPROACH'.
- 3) Press the **ENT** Key. The aircraft automatically sequences to the MAHP.

Or:

Press the Go-Around Button.

COURSE TO ALTITUDE

In this missed approach procedure, the altitude immediately following the MAP (in this case '6368ft') is not part of the published procedure. It is simply a Course to Altitude (CA) leg which guides the aircraft along the runway centerline until the altitude required to safely make the first turn toward the MAHP is exceeded. This altitude is provided by Jeppesen, and may be below, equal to, or above the published minimums for this approach. In this case, if the aircraft altitude is below the specified altitude (6,368 feet) after crossing the MAP, a direct-to is established to provide a course on runway heading until an altitude of 6,368 feet is reached. After reaching 6,368 feet, a direct-to is established to the published MAHP (in this case MOGAL). If the aircraft altitude is above the specified altitude after crossing the MAP, a direct-to is established to the published fix (MOGAL) to begin the missed approach procedure.

In some missed approach procedures this Course to Altitude leg may be part of the published procedure. For example, a procedure may dictate a climb to 5,500 feet, then turn left and proceed to the Missed Approach Hold Point (MAHP). In this case, the altitude would appear in the list of waypoints as '5500ft'. Again, if the aircraft altitude is lower than the prescribed altitude, a direct-to is established on a Course to Altitude leg when the missed approach procedure is activated.

ACTIVE FLIGHT PLAN			
KMKC / KCOS			
	DTK	DIS	ALT
FSHER	352°	9.8NM	9500FT
PYNON	352°	11.9NM	9500FT
Approach - KCOS-RNAV 35R _{GPS} LPV			
HABUK <i>iaf</i>	021°	5.9NM	9000FT
FALUR	261°	5.0NM	8600FT
CEGIX <i>faf</i>	351°	6.0NM	7800FT
RW35R <i>map</i>	351°	5.1NM	
6368FT	348°	0.4NM	6370FT
MOGAL <i>mahp</i>			10000FT
HOLD	168°	6.0NM	

Figure 5-98 Course to Altitude

5.9 TRIP PLANNING

The G1000 allows the pilot to view trip planning information, fuel information, and other information for a specified flight plan or flight plan leg based on automatic data, or based on manually entered data. Weight planning is also available, based on fuel sensor data and the active flight plan (to estimate remaining fuel).

TRIP PLANNING

All of the input of data needed for calculation and viewing of the statistics is done on the Trip Planning Page located in the AUX Page Group.

Selected Flight Plan Segment
 - FPL Number/Cumulative Legs (CUM or REM) or Leg Number (NN)
 - Waypoints Defining Selected Flight Plan/Flight Plan Leg

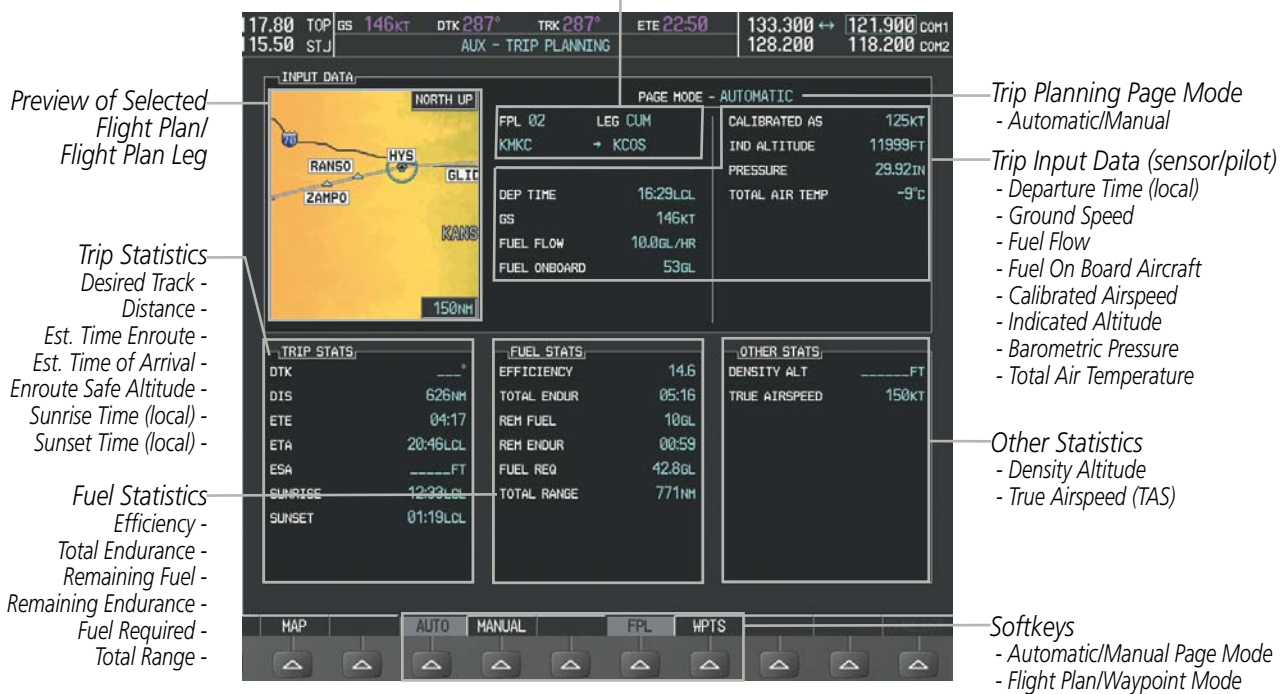

Figure 5-99 Trip Planning Page

The trip planning inputs are based on sensor inputs (automatic page mode) or on pilot inputs (manual page mode). Some additional explanation of the sources for some of the inputs is as follows:

- Departure time (DEP TIME) - This defaults to the current time in automatic page mode. The computations are from the aircraft present position, so the aircraft is always just departing.
- Calibrated airspeed (CALIBRATED AS) - The primary source is from the air data system, and the secondary source of information is GPS ground speed.
- Indicated altitude (IND ALTITUDE) - The primary source is the barometric altitude, and the secondary source of information is GPS altitude.

TRIP STATISTICS

The trip statistics are calculated based on the selected starting and ending waypoints and the trip planning inputs.

In flight plan mode (FPL) with a stored flight plan selected (NN), and the entire flight plan (CUM) selected, the waypoints are the starting and ending waypoints of the selected flight plan.

In flight plan mode (FPL) with a stored flight plan selected (NN), and a specific leg (NN) selected, the waypoints are the endpoints of the selected leg.

In flight plan mode (FPL) with the active flight plan selected (00), and the remaining flight plan (REM) selected, the 'from' waypoint is the present position of the aircraft and the 'to' waypoint is the endpoint of the active flight plan.

In flight plan mode (FPL) with the active flight plan selected (00), and a specific leg (NN) selected, the 'from' waypoint is the current aircraft position and the 'to' waypoint is the endpoint of the selected leg.

In waypoint (WPTS) mode these are manually selected waypoints (if there is an active flight plan, these default to the endpoints of the active leg).

Some of the calculated trip statistics are dashed when the selected leg of the active flight plan has already been flown.

- Desired Track (DTK) - DTK is shown as nnn° and is the desired track between the selected waypoints. It is dashed unless only a single leg is selected.
- Distance (DIS) - The distance is shown in tenths of units up to 99.9, and in whole units up to 9999.
- Estimated time enroute (ETE) - ETE is shown as hours:minutes until less than an hour, then it is shown as minutes:seconds.
- Estimated time of arrival (ETA) - ETA is shown as hours:minutes and is the local time at the destination.
 - If in waypoint mode then the ETA is the ETE added to the departure time.
 - If a flight plan other than the active flight plan is selected it shows the ETA by adding to the departure time all of the ETEs of the legs up to the selected leg. If the entire flight plan is selected, then the ETA is calculated as if the last leg of the flight plan was selected.
 - If the active flight plan is selected the ETA reflects the current position of the aircraft and the current leg being flown. The ETA is calculated by adding to the current time the ETEs of the current leg up to and including the selected leg. If the entire flight plan is selected, then the ETA is calculated as if the last leg of the flight plan was selected.
- Enroute safe altitude (ESA) - The ESA is shown as nnnnnFT
- Destination sunrise and sunset times (SUNRISE, SUNSET) - These times are shown as hours:minutes and are the local time at the destination.

FUEL STATISTICS

The fuel statistics are calculated based on the selected starting and ending waypoints and the trip planning inputs. Some of the calculated trip statistics are dashed when the selected leg of the active flight plan has already been flown.

- Fuel efficiency (EFFICIENCY) - This value is calculated by dividing the current ground speed by the current fuel flow.
- Time of fuel endurance (TOTAL ENDUR) - This time is shown as hours:minutes. This value is obtained by dividing the amount of fuel on board by the current fuel flow.
- Fuel on board upon reaching end of selected leg (REM FUEL) - This value is calculated by taking the amount of fuel onboard and subtracting the fuel required to reach the end of the selected leg.
- Fuel endurance remaining at end of selected leg (REM ENDUR) - This value is calculated by taking the time of fuel endurance and subtracting the estimated time enroute to the end of the selected leg.
- Fuel required for trip (FUEL REQ) - This value is calculated by multiplying the time to go by the fuel flow.
- Total range at entered fuel flow (TOTAL RANGE) - This value is calculated by multiplying the time of fuel endurance by the ground speed.

OTHER STATISTICS

These statistics are calculated based on the system sensor inputs or the manual trip planning inputs.

- Density altitude (DENSITY ALT)
- True airspeed (TRUE AIRSPEED)

The pilot may select automatic (AUTO) or manual (MANUAL) page mode, and flight plan (FPL) or waypoint (WPTS) mode. In automatic page mode, only the FPL, LEG, or waypoint IDs are editable (based on FPL/WPTS selection).

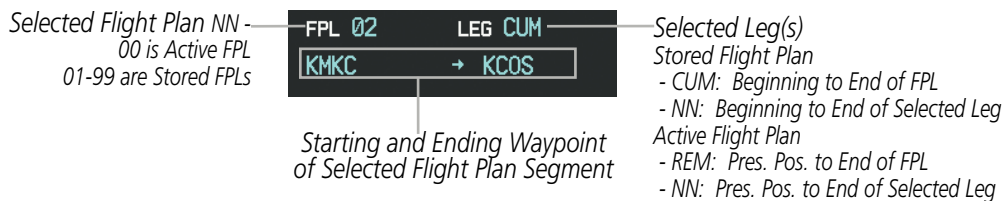

Figure 5-100 Trip Planning Page - Flight Plan Mode



Figure 5-101 Trip Planning Page - Waypoint Mode

Selecting automatic or manual page mode:

Press the **AUTO** Softkey or the **MANUAL** Softkey; or press the **MENU** Key, highlight 'Auto Mode' or 'Manual Mode', and press the **ENT** Key.

Selecting flight plan or waypoint mode:

Press the **FPL** Softkey or the **WPTS** Softkey; or press the **MENU** Key, highlight 'Flight Plan Mode' or 'Waypoints Mode', and press the **ENT** Key.

Selecting a flight plan and leg for trip statistics:

- 1) Press the **FMS** Knob to activate the cursor in the flight plan number field.
- 2) Turn the small **FMS** Knob to select the desired flight plan number.
- 3) Turn the large **FMS** Knob to highlight 'CUM' or 'REM'. The statistics for each leg can be viewed by turning the small **FMS** Knob to select the desired leg. The Inset Map also displays the selected data.

Selecting waypoints for waypoint mode:

- 1) Press the **WPTS** Softkey; or press the **MENU** Key, highlight 'Waypoints Mode', and press the **ENT** Key. The cursor is positioned in the waypoint field directly below the FPL field.
- 2) Turn the **FMS** knobs to select the desired waypoint (or select from the Page Menu 'Set WPT to Present Position' if that is what is desired), and press the **ENT** Key. The cursor moves to the second waypoint field.
- 3) Turn the **FMS** knobs to select the desired waypoint, and press the **ENT** Key. The statistics for the selected leg are displayed.

In manual page mode, the other eight trip input data fields must be entered by the pilot, in addition to flight plan and leg selection.

Entering manual data for trip statistics calculations:

- 1) Press the **MANUAL** Softkey or select 'Manual Mode' from the Page Menu, and press the **ENT** Key. The cursor may now be positioned in any field in the top right two boxes.
- 2) Turn the **FMS** Knobs to move the cursor onto the DEP TIME field and enter the desired value. Press the **ENT** Key. The statistics are calculated using the new value and the cursor moves to the next entry field. Repeat until all desired values have been entered.

5.10 RAIM PREDICTION

RAIM (Receiver Autonomous Integrity Monitoring) is a GPS receiver function that performs a consistency check on all tracked satellites. RAIM ensures that the available satellite geometry allows the receiver to calculate a position within a specified RAIM protection limit (2.0 nm for oceanic, 2.0 nm for enroute, 1.0 nm for terminal, and 0.3 nm for non-precision approaches). During oceanic, enroute, and terminal phases of flight, RAIM is available nearly 100% of the time. The RAIM prediction function also indicates whether RAIM is available at a specified date and time. RAIM computations predict satellite coverage within ± 15 min of the specified arrival date and time. Because of the tighter protection limit on approaches, there may be times when RAIM is not available. RAIM prediction must be initiated manually if there is concern over SBAS coverage at the destination or some other reason that compromises navigation precision. If RAIM is not predicted to be available for the final approach course, the approach does not become active. If RAIM is not available when crossing the FAF, the missed approach procedure must be flown.



Figure 5-102 RAIM Prediction

Predicting RAIM availability at a selected waypoint:

- 1) Select the AUX-GPS Status Page.
- 2) Press the **FMS** Knob. The RAIM Prediction 'WAYPOINT' field is highlighted.
- 3) Turn the small **FMS** Knob to display the Waypoint Information Window. (Turning it clockwise displays a blank Waypoint Information Window, turning it counter-clockwise displays the Waypoint Information Window with a waypoint selection submenu allowing selection of active flight plan, nearest, recent, user, or airway waypoints).
- 4) Enter the identifier, facility, or city name of the departure waypoint; or select a waypoint from the submenu of waypoints and press the **ENT** Key to accept the waypoint entry.

- 5) Turn the FMS Knobs to enter an arrival time and press the **ENT** Key.
- 6) Turn the FMS Knobs to enter an arrival date and press the **ENT** Key.
- 7) Press the **ENT** Key with 'COMPUTE RAIM?' highlighted to begin the computation.

Predicting RAIM availability at the aircraft present position:

- 1) Select the AUX-GPS Status Page.
- 2) Press the **FMS** Knob. The RAIM Prediction 'WAYPOINT' field is highlighted.
- 3) Press the **MENU** Key, highlight 'Set WPT to Present Position', and press the **ENT** Key.
- 4) Press the **ENT** Key to accept the waypoint entry.
- 5) Turn the FMS Knobs to enter an arrival time and press the **ENT** Key.
- 6) Turn the FMS Knobs to enter an arrival date and press the **ENT** Key.
- 7) Press the **ENT** Key with 'COMPUTE RAIM?' highlighted to begin the computation.

Status of the RAIM computation for the selected waypoint, time, and date is displayed at the bottom of the RAIM PREDICTION Box as follows:

- 'COMPUTE RAIM?' - RAIM has not been computed.
- 'COMPUTING AVAILABILITY' - RAIM calculation is in progress.
- 'RAIM AVAILABLE' - RAIM is predicted to be available.
- 'RAIM NOT AVAILABLE' - RAIM is predicted to be unavailable.

The Satellite Based Augmentation System (SBAS) provides increased navigation accuracy when available. SBAS can be enabled or disabled manually on the GPS Status Page.



Figure 5-103 SBAS Display - Active

- SYSTEM OVERVIEW
- FLIGHT INSTRUMENTS
- EIS
- AUDIO PANEL & CNS
- FLIGHT MANAGEMENT
- HAZARD AVOIDANCE
- AFCS
- ADDITIONAL FEATURES
- APPENDICES
- INDEX

Enabling/Disabling SBAS:

- 1) Select the AUX-GPS Status Page.
- 2) Press the **SBAS** softkey.
- 3) Press the **FMS** Knob, and turn the large FMS Knob to highlight 'EGNOS', 'MSAS' or 'WAAS'.
- 4) Press the **ENT** Key to disable SBAS. Press the **ENT** Key again to enable SBAS.



Figure 5-104 SBAS Display - Disabled

5.11 NAVIGATING A FLIGHT PLAN

The following discussion is an example of navigating a flight plan with an LPV approach using the SBAS capable GPS system while the G1000 provides vertical guidance through descents. A flight plan with an LNAV approach would be navigated in much the same way, but would not include vertical guidance when the final approach course is active.



NOTE: The following example flight plan is for instructional purposes only. All database information depicted should be considered not current.

The example is a flight plan from KMKC to KCOS filed using the TIFTO2 departure, various Victor Airways, and the DBRY1 arrival with the transition at TBE. The flight plan includes an enroute altitude of 12,000 feet, an LPV (WAAS) approach selected for runway 35R, and a missed approach executed at the Missed Approach Point (MAP). A few enroute changes are demonstrated.

- 1) Prior to departure, the TIFTO2 departure, the airways, and the DBRY1 arrival at KCOS are loaded. See the Procedures section for loading departures and arrivals. Note the magenta arrow in Figure 5-105 indicating the active departure leg.

After takeoff, ATC assigns a heading of 240°.

- 2) Figure 5-105 shows the aircraft on the assigned heading of 240°. 'TERM' (Terminal) is the current CDI flight phase displayed on the HSI indicating 1.0 nm CDI scaling.



Figure 5-105 Assigned Heading of 240°

- 3) ATC now assigns routing to join V4. A heading of 290° is assigned to intercept V4. The aircraft turns to heading 290° as seen in Figure 5-106.

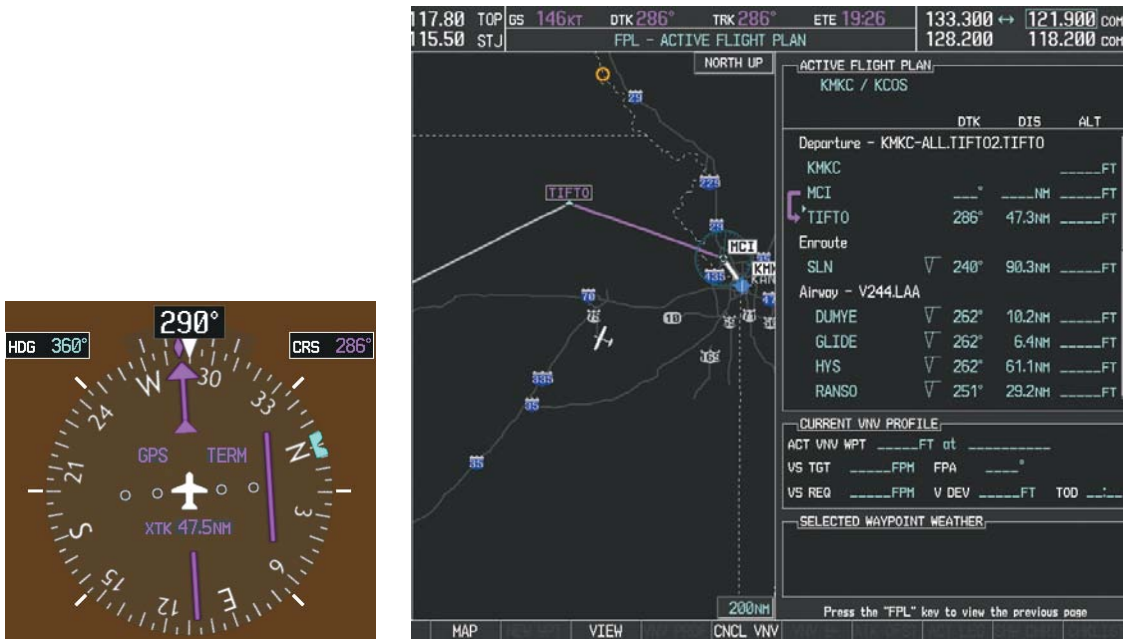

Figure 5-106 Assigned Heading of 290°

- 4) Enter V4 into the flight plan.
 - a) Press the **FMS** Knob to activate the cursor.

- b) The desired entry point for V4 (TOP) must be entered. Turn the large **FMS** Knob to highlight the desired flight plan insertion point (SLN) as shown in Figure 5-107. When the V4 entry point (TOP) is inserted, it is placed immediately above the highlighted waypoint (SLN).

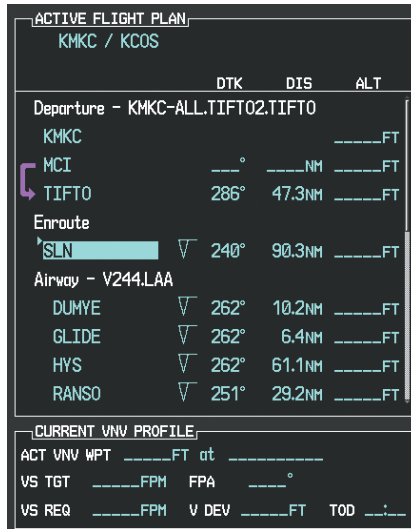

Figure 5-107 Begin Adding V4 to the Flight Plan

- c) Turn the small **FMS** Knob to display the Waypoint Information Window. Enter the desired entry point for V4, Topeka VOR (TOP), as shown in Figure 5-108.



Figure 5-108 Entering V4 Entry Point

d) Press the **ENT** Key. TOP is inserted into the flight plan as in Figure 5-109.

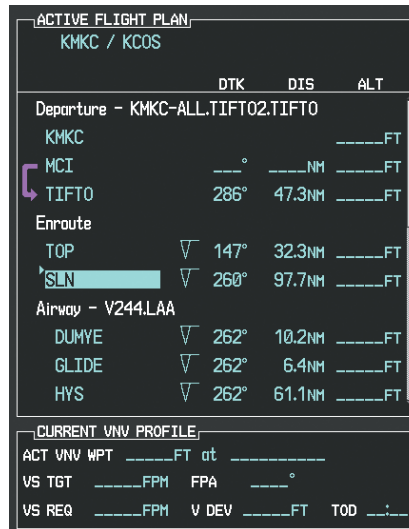

Figure 5-109 TOP Inserted into the Flight Plan

e) With SLN still highlighted as in Figure 5-109, turn the small **FMS** Knob clockwise. The Waypoint Information Page is displayed and the **LD AIRWY** Softkey is now available.

f) Press the **LD AIRWY** Softkey to display the list of available airways for TOP as seen in Figure 5-110.

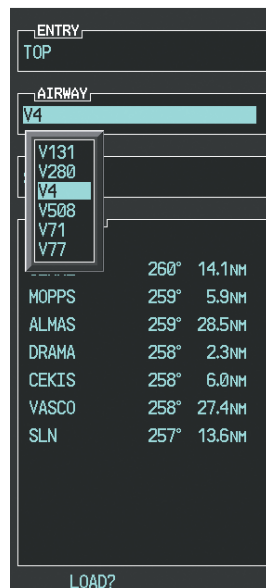

Figure 5-110 List of Available Airways for TOP

g) Turn either **FMS** Knob to highlight V4 in the list as seen in Figure 5-110.

h) Press the **ENT** Key. The list of available exits for V4 is now displayed as in Figure 5-111.

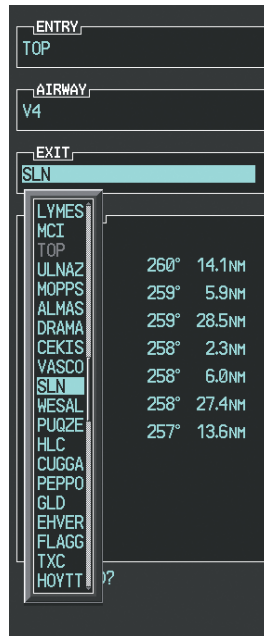

Figure 5-111 List of Available Exits for V4

- i) If necessary, turn either **FMS** Knob to select the desired exit. In this case Salina VOR (SLN) is selected as in Figure 5-111.
- j) Press the **ENT** Key. The selected airway and exit are displayed, and the prompt “LOAD?” highlighted as in Figure 5-112.

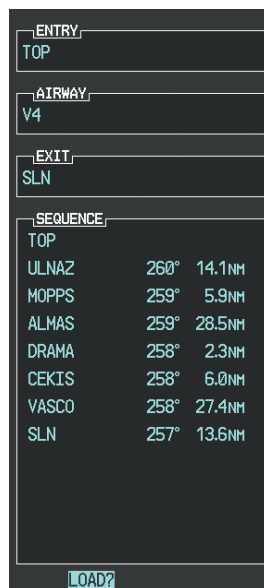

Figure 5-112 Ready to Load V4

k) Press the **ENT** Key.

I) V4 is now loaded into the flight plan as shown in Figure 5-113.

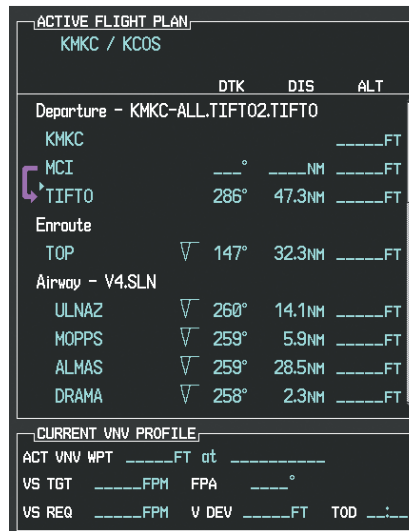

Figure 5-113 V4 is Loaded in the Flight Plan

- 5) Making V4 the active leg of the flight plan.
 - a) Press the **FMS** Knob to activate the cursor.
 - b) Turn the large **FMS** Knob to highlight ULNAZ. The TO waypoint of the leg is selected in order to activate the leg.
 - c) Press the **ACT LEG** Softkey. The confirmation window is now displayed as in Figure 5-114. Note the TOP to ULNAZ leg is actually part of V4.

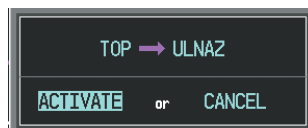

Figure 5-114 Confirm Active Leg

- d) Verify the displayed leg is the desired leg and press the **ENT** Key. Note in Figure 5-115, the magenta arrow in the flight plan window and magenta line on the map indicating V4 is now the active flight plan leg. Note the phase of flight remained in Terminal (TERM) mode up to this point because a departure leg was active. Since a leg after the departure is now active, the current CDI flight phase is ENR (Enroute) and CDI scaling has changed to 2.0 nm.

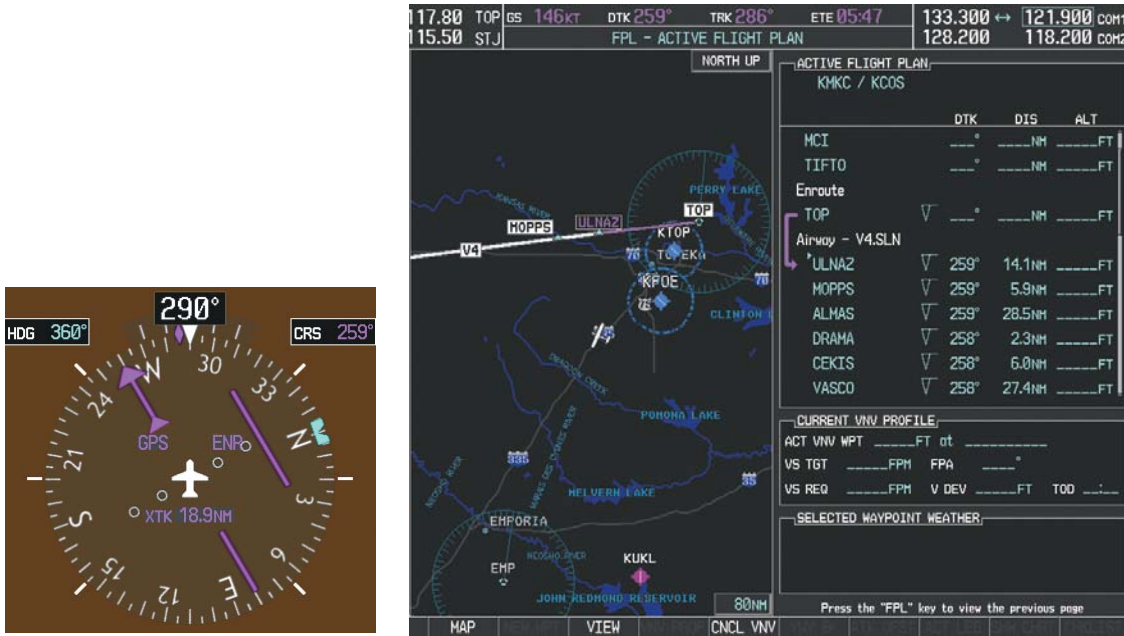

Figure 5-115 V4 Now Active Leg

- 6) The aircraft continues on heading 290°. When crosstrack distance is less than 2.0 nm, the XTK disappears from the HSI and the CDI is positioned on the last dot indicating a 2.0 nm distance from the centerline of the next course.

7) As the CDI approaches center, the aircraft turns onto the active leg as seen in Figure 5-116.

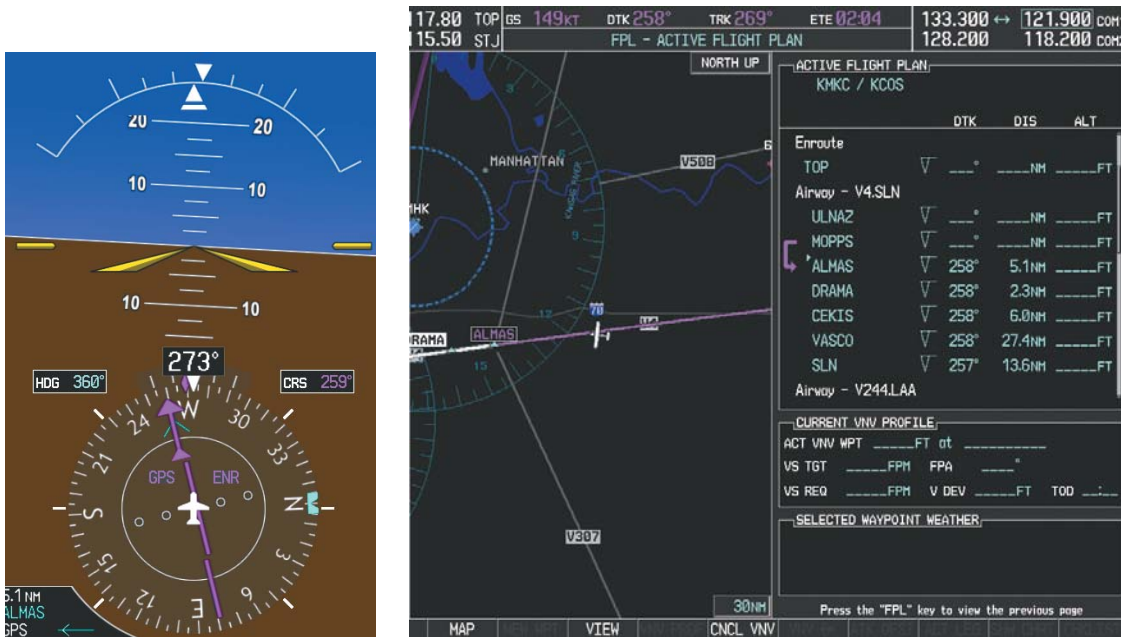

Figure 5-116 Turn on to Active Leg

8) At SLN, Victor Airway 244 (V244) is intercepted. Turn prompts are displayed in the PFD Navigation Status Box as seen in Figure 5-117.

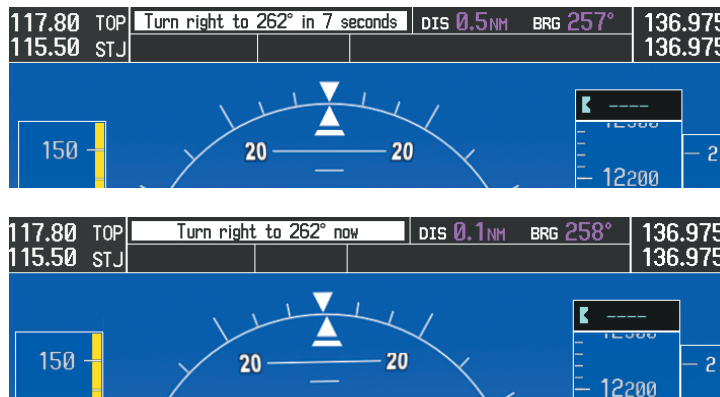

Figure 5-117 Turn to Intercept V244

9) As seen in Figure 5-118, V244 is now the active flight plan leg.



Figure 5-118 V244 Now Active Leg

10) At Lamar VOR (LAA) V263 is intercepted. See Figure 5-119.



Figure 5-119 HYS to LAA Leg Active

11) ATC grants clearance to proceed direct to the OPSHN intersection to begin the arrival procedure. ATC advises to expect an altitude of 10,000 feet at OPSHN.

- a) Press the **FMS** Knob to activate the cursor.
- b) Turn the large **FMS** Knob to select OPSHN in the flight plan list.
- c) Press the **Direct-to** (D>) Key. The Direct-to Window is now displayed as shown in Figure 5-120.



Figure 5-120 Direct To OPSHN

d) Turn the large **FMS** Knob to place the cursor in the VNV altitude field as shown in Figure 5-121.



Figure 5-121 Enter VNV Altitude

e) An altitude of 10,000 feet is entered as requested by ATC.

f) Press the **ENT** Key. The cursor is now displayed in the VNV offset field as shown in Figure 5-122.



Figure 5-122 Enter VNV Offset Distance

g) Enter the offset, or distance from the waypoint at which to reach the selected altitude. In this case, three miles prior to OPSHN is entered. In other words, the G1000 gives vertical guidance so the aircraft arrives at an altitude of 10,000 feet three miles prior to OPSHN.

h) Press the **ENT** Key twice to activate the direct-to. Note, in Figure 5-123, the magenta arrow indicating the direct-to OPSHN after the offset waypoint for OPSHN. The preceding offset waypoint indicates the offset distance and altitude that were previously entered. The remaining waypoints in the loaded arrival procedure have no database specified altitudes, therefore, dashes are displayed. Keep the CDI centered and maintain a track along the magenta line to OPSHN.

Note the Direct-to waypoint is within the loaded arrival procedure, therefore, phase of flight scaling for the CDI changes to Terminal Mode and is annunciated by displaying 'TERM' on the HSI.



NOTE: If the loaded arrival procedure has waypoints with altitude constraints retrieved from the database to be used as is, the altitude must be manually accepted by placing the cursor over the desired altitude, then pressing the ENT Key. The altitude is now displayed as light blue meaning it is used by the system to determine vertical speed and deviation guidance.

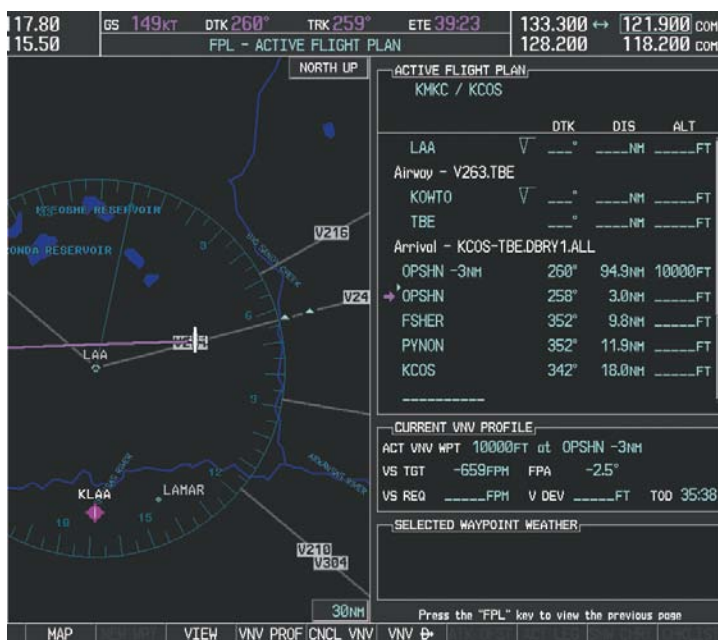

Figure 5-123 Direct-to Active

12) The aircraft is proceeding to OPSHN. The expected approach is the RNAV LPV approach to runway 35R, so it is selected.

a) Press the **PROC** Key to display the Procedures Window.

b) 'SELECT APPROACH' should be highlighted as shown in Figure 5-124.

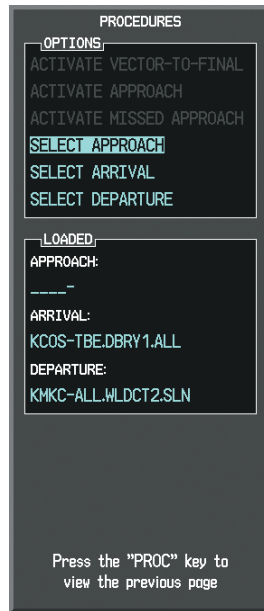

Figure 5-124 Procedures Window

c) Press the ENT Key. A list of available approaches for the destination airport is displayed as in Figure 5-125.

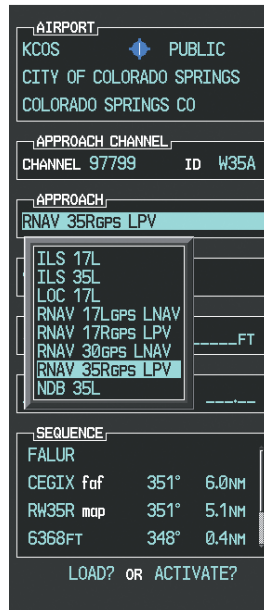

Figure 5-125 List of Available Approaches

d) Turn either FMS Knob to select the LPV approach for 35R as shown in Figure 5-125.

e) Press the **ENT** Key. A list of available transitions for the selected approach is displayed as in Figure 5-126.

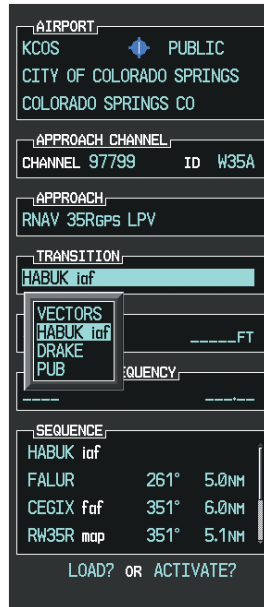

Figure 5-126 List of Available Transitions

f) Turn either **FMS** Knob to select the desired transition. In this case, the Initial Approach Fix (IAF) at HABUK is used.

g) Press the **ENT** Key.

h) Barometric Minimums

To set 'MINIMUMS', turn the small **FMS** Knob to select 'BARO', and press the **ENT** Key. Turn the small **FMS** Knob to select the altitude, and press the **ENT** Key.

Or:

To skip setting minimums, press the **ENT** Key.

- SYSTEM OVERVIEW
- FLIGHT INSTRUMENTS
- EIS
- AUDIO PANEL & CNS
- FLIGHT MANAGEMENT
- HAZARD AVOIDANCE
- AFCS
- ADDITIONAL FEATURES
- APPENDICES
- INDEX

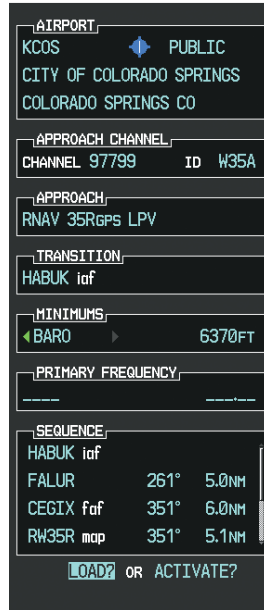

Figure 5-127 Barometric Minimums Set

- i) With 'LOAD?' highlighted, again press the **ENT** Key. The selected approach is added to the flight plan as seen in Figure 5-128.



Figure 5-128 Loaded Approach

- 13) Note the altitude constraints associated with each of the approach waypoints as seen in Figure 5-129. These altitudes are loaded from the database and are displayed as light blue text, indicating these values are “designated” for use in computing vertical deviation guidance.

Note: To no longer use the displayed altitude for calculating vertical deviation guidance, perform the following:

- a) Press the **FMS** Knob to activate the cursor.
- b) Turn the small **FMS** Knob to highlight the desired altitude.
- c) Press the **CLR** Key.
- d) Press the **FMS** Knob to deactivate the cursor.

After making the altitude “non-designated”, it is displayed as white text.

Altitude constraint values associated with the Final Approach Fix (FAF) and waypoints beyond the FAF cannot be designated for vertical guidance. These altitude values are always displayed as white text, as in Figure 5-129. Vertical guidance from the FAF and on to the Missed Approach Point (MAP) is given using the SBAS GPS altitude source, therefore, the displayed altitude values are for reference only.

ACTIVE FLIGHT PLAN			
KMKC / KCOS			
	DTK	DIS	ALT
FSHER	352°	9.8NM	10000FT
PYNON	352°	11.9NM	10000FT
Approach - KCOS-RNAV 35R GPS LPV			
HABUK iaf	021°	5.9NM	9000FT
FALUR	261°	5.0NM	8600FT
CEGIX faf	351°	6.0NM	7800FT
RW35R map	351°	5.1NM	
6368FT	348°	0.4NM	6370FT
MOGAL mahp			10000FT
HOLD	168°	6.0NM	

CURRENT VNV PROFILE			
ACT VNV WPT 10000FT at OPSHN -3NM			
VS TGT	-791FPM	FPA	-3.0°
VS REQ	_____FPM	V DEV	_____FT TOD 27:53

Figure 5-129 Vertical Guidance is Active to the FAF

- 14) As the aircraft approaches OP SHN, it may be desirable to adjust the speed, or steepness of the upcoming descent. The default Flight Path Angle (FPA) is -3.0 degrees and a required vertical speed is computed to maintain the -3.0 FPA. To change the vertical flight path, perform the following steps.
 - a) Press the **VNV PROF** Softkey to place the cursor in the target vertical speed field (VS TGT) as shown in Figure 5-130.
 - b) At this point, the descent vertical speed can be selected, or the FPA can be selected. Turn the large **FMS** Knob to select the desired selection field, then turn the small **FMS** Knob to enter the desired value.

Note the information now displayed in the 'CURRENT VNV PROFILE' box. Also, note the offset waypoint (orange box) and gray circle are now displayed on the map. The gray circle marks the Top of Descent (TOD). In this example, vertical guidance is provided at the TOD that results in a -3.0 degree FPA descent to an altitude of 10,000 feet upon reaching the offset waypoint.



Figure 5-130 Adjusting the Descent

- c) Press the **ENT** Key.

- 15) As seen in Figure 5-130, the aircraft is approaching TOD. Note the target vertical speed required to reach the selected altitude. The Vertical Deviation Indicator (VDI) and the Required Vertical Speed Indicator (RVSI) are now displayed on the PFD as shown in Figure 5-131. When the aircraft is within one minute of the TOD, it is annunciated as shown in Figure 5-132, and an aural alert 'Vertical track' will be heard.



Figure 5-131 Approaching Top of Descent (TOD)

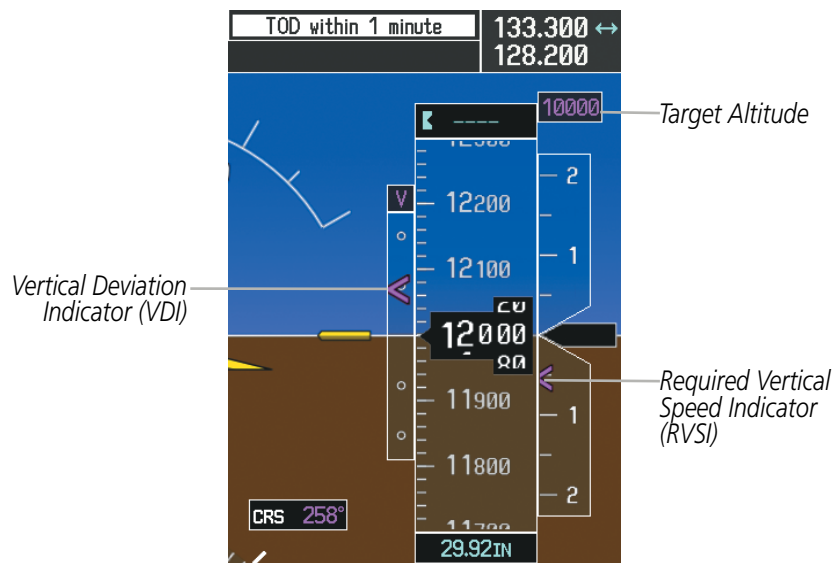

Figure 5-132 VDI & RVSI Upon Reaching Top of Descent (TOD)

- 16) Upon reaching TOD, a descent vertical speed is established by placing the VSI pointer in line with the RVSI as shown in Figure 5-133.

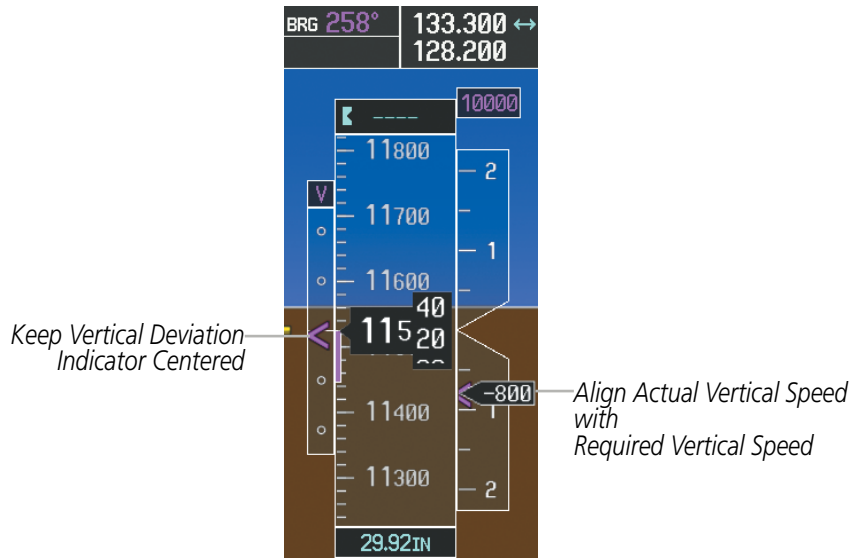

Figure 5-133 VDI & RVSI Showing Correctly Established Descent

- 17) When the aircraft is one minute from the bottom of descent (BOD) it is annunciated as shown in Figure 5-134. Upon reaching the offset waypoint for OPSHN, the aircraft is at 10,000 feet.

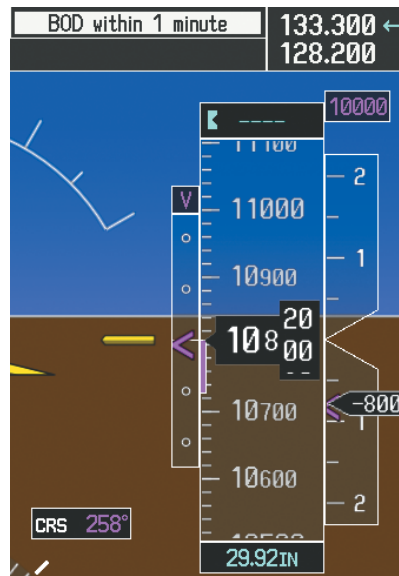

Figure 5-134 Approaching Bottom of Descent (BOD) at OPSHN Offset Waypoint

- 18) The aircraft is approaching OPSHN. The upcoming turn and next heading are annunciated at the top left of the PFD as seen in Figure 5-135. Initiate the turn and maneuver the aircraft on a track through the turn radius to intercept the magenta line for the OPSHN to FSHER leg and center the CDI.

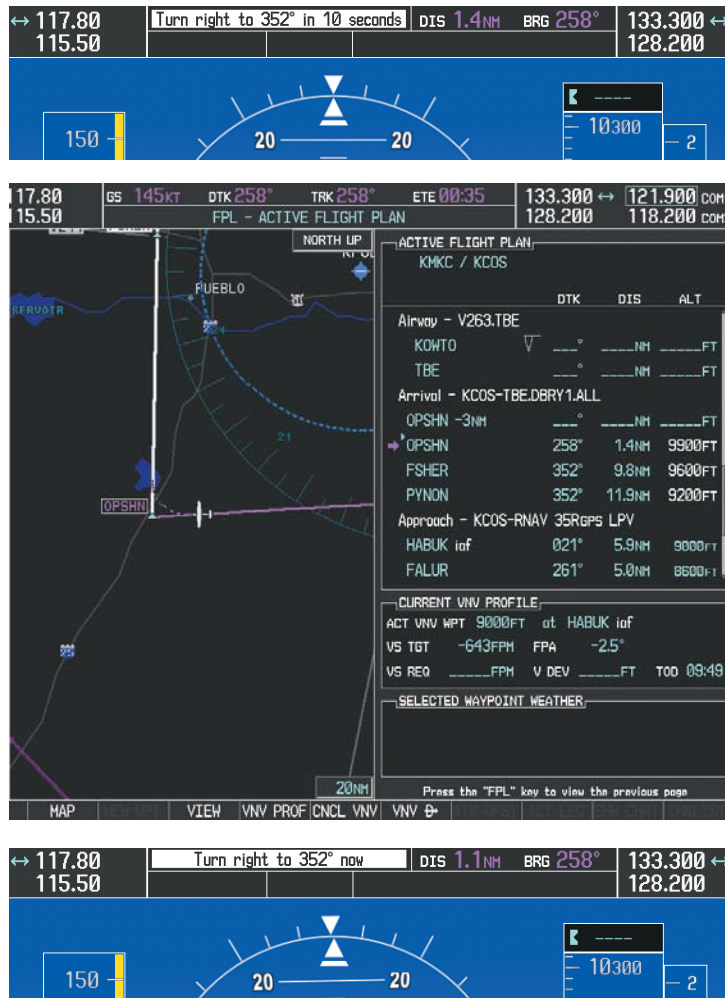

Figure 5-135 Turn to intercept OPSHN to FSHER Leg

- 19) After passing OPSHN, the next leg of the arrival turns magenta as shown in Figure 5-136. The magenta arrow in the flight plan list now indicates the OPSHN to FSHER leg of the arrival procedure is now active.

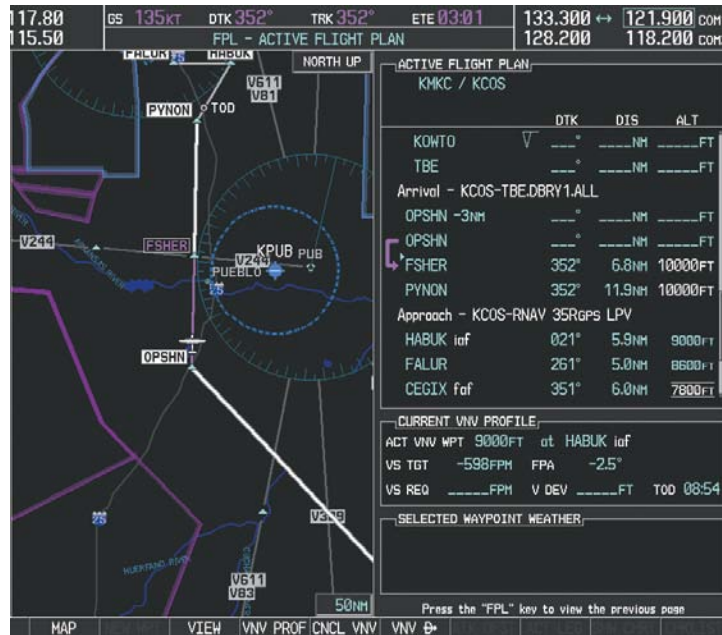

Figure 5-136 Tracking the OPSHN to FSHER Leg

- 20) The flight continues through the arrival procedure to PYNON (see Figure 5-137). At a point 31 nm from the destination airport, the phase of flight scaling for the CDI changes to Terminal Mode and is annunciated by displaying 'TERM' on the HSI.

A descent to HABUK is in the next leg. Note the TOD point on the map. Annunciations for the upcoming turn and descent, as well as the VDI and RVSI, appear on the PFD as the flight progresses.

- SYSTEM OVERVIEW
- FLIGHT INSTRUMENTS
- EIS
- AUDIO PANEL & CNS
- FLIGHT MANAGEMENT
- HAZARD AVOIDANCE
- AFCS
- ADDITIONAL FEATURES
- APPENDICES
- INDEX



Figure 5-137 Approaching PYNON

- 21) Upon passing PYNON the approach procedure automatically becomes active. The approach may be activated at any point to proceed directly to the IAF. In this example, the aircraft has progressed through the final waypoint of the arrival and the flight plan has automatically sequenced to the IAF as the active leg, activating the approach procedure (see Figure 5-138).



Figure 5-138 Approach is Now Active

Note: To manually activate the approach procedure, perform the following steps:

- Press the **PROC** Key.
- Turn the large **FMS** Knob to highlight 'ACTIVATE APPROACH' as shown in Figure 5-139.
- Press the **ENT** Key to activate the approach.

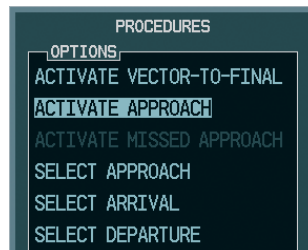

Figure 5-139 Manually Activate Approach

- 22) The IAF is the next waypoint. At the TOD, establish a descent vertical speed as previously discussed in Step 16. The aircraft altitude is 9,000 feet upon reaching HABUK.



Figure 5-140 Descending Turn to the Initial Approach Fix (IAF)

- 23) After crossing FALUR the next waypoint is the FAF. The flight phase changes to LPV on the HSI indicating the current phase of flight is in Approach Mode and the approach type is LPV. CDI scaling changes accordingly and is used much like a localizer when flying an ILS approach. The RVSI is no longer displayed and the VDI changes to the Glidepath Indicator (as shown in Figure 5-141) when the final approach course becomes active.

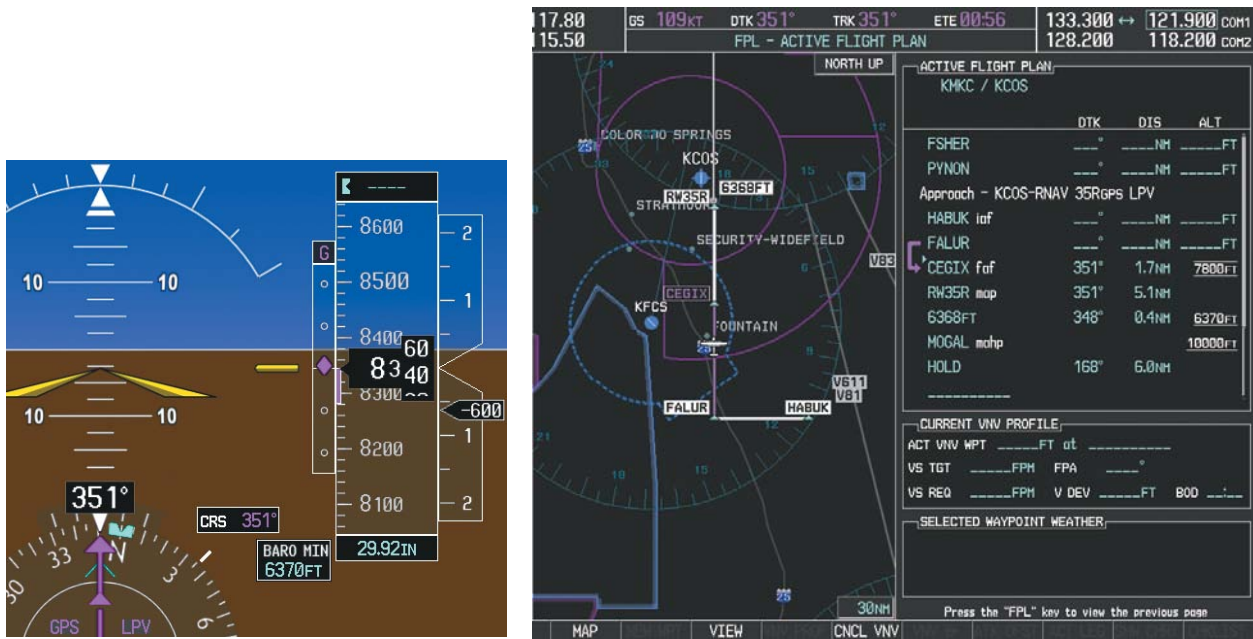

Figure 5-141 Descending to the FAF

The descent continues through the FAF (CEGIX) using the Glidepath Indicator, as one would use a glideslope indicator, to obtain an altitude "AT" 7,800 feet at the FAF. Note the altitude restriction lines over and under (At) the altitude in the 'ALT' field in Figure 5-141.

- 24) After crossing CEGIX, the aircraft continues following the glidepath to maintain the descent to “AT or ABOVE” 6,370 feet at the Missed Approach Point (MAP) (RW35R) as seen in Figure 5-142.

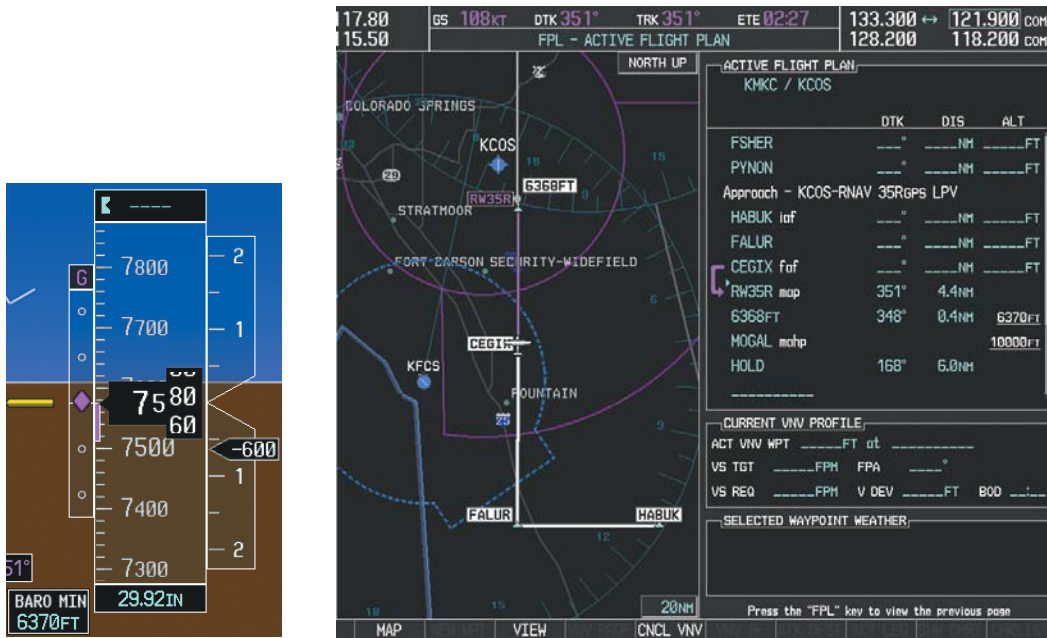

Figure 5-142 Descending to the Missed Approach Point

In this missed approach procedure, the altitude immediately following the MAP (in this case '6368ft') is not part of the published procedure. It is simply a Course to Altitude (CA) leg which guides the aircraft along the runway centerline until the altitude required to safely make the first turn toward the MAHP is exceeded. This altitude is provided by Jeppesen, and may be below, equal to, or above the published minimums for this approach. In this case, if the aircraft altitude is below the specified altitude (6,368 feet) after crossing the MAP, a direct-to is established to provide a course on runway heading until an altitude of 6,368 feet is reached. After reaching 6,368 feet, a direct-to is established to the published MAHP (in this case MOGAL). If the aircraft altitude is above the specified altitude after crossing the MAP, a direct-to is established to the published fix (MOGAL) to begin the missed approach procedure.

In some missed approach procedures this Course to Altitude leg may be part of the published procedure. For example, a procedure may dictate a climb to 5,500 feet, then turn left and proceed to the Missed Approach Hold Point (MAHP). In this case, the altitude would appear in the list of waypoints as '5500ft'. Again, if the aircraft altitude is lower than the prescribed altitude, a direct-to is established on a Course to Altitude leg when the missed approach procedure is activated.

- 25) Upon reaching the MAP, it is decided to execute a missed approach. Automatic waypoint sequencing is suspended past the MAP. Press the **SUSP** Softkey on the PFD to resume automatic waypoint sequencing through the missed approach procedure.

A direct-to is initiated to MOGAL, which is the Missed Approach Hold Point (MAHP) as seen in Figure 5-143. The aircraft is climbing to 10,000 feet. The CDI flight phase now changes from LPV to MAPR as seen on the HSI.



Figure 5-143 Missed Approach Active

- 26) The aircraft continues climbing to "AT or ABOVE" 10,000 feet at MOGAL. A holding pattern is established at the MAHP (MOGAL) as shown in Figure 5-144.

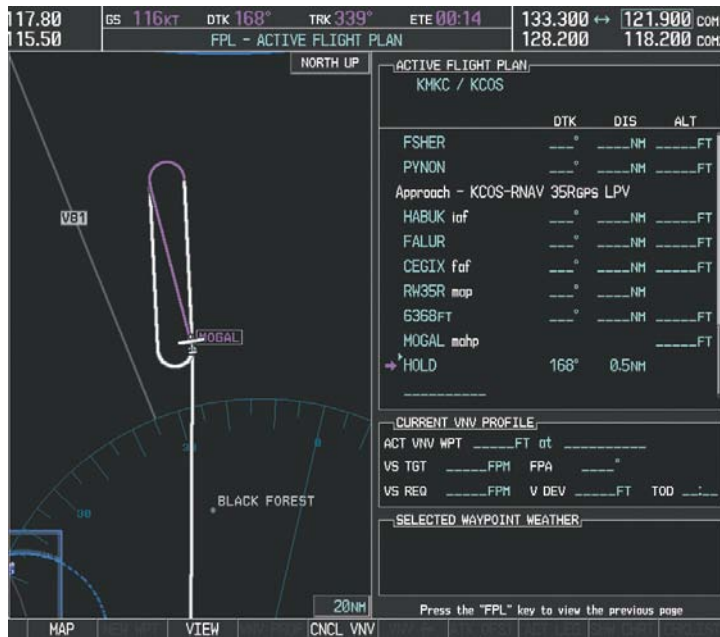

Figure 5-144 Establishing the Holding Pattern

- 27) The aircraft maintains 10,000 feet while following the magenta line through the hold as in Figure 5-145.

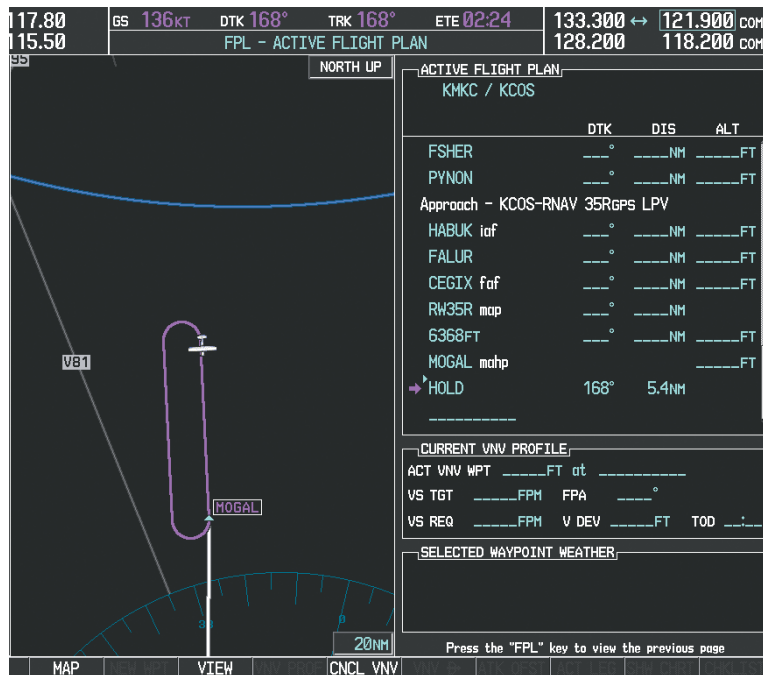

Figure 5-145 Hold Established

5.12 ABNORMAL OPERATION

This section discusses the Dead Reckoning mode of operation and the subsequent indications.



NOTE: *Dead Reckoning Mode only functions in Enroute (ENR) or Oceanic (OCN) phase of flight. In all other phases, an invalid GPS solution produces a "NO GPS POSITION" annunciation on the map and the G1000 stops using GPS.*

While in Enroute or Oceanic phase of flight, if the G1000 detects an invalid GPS solution or is unable to calculate a GPS position, the system automatically reverts to Dead Reckoning (DR) Mode. In DR Mode, the G1000 uses its last-known position combined with continuously updated airspeed and heading data (when available) to calculate and display the aircraft's current estimated position.

It is important to note that estimated navigation data supplied by the G1000 in DR Mode may become increasingly unreliable and must not be used as a sole means of navigation. If while in DR Mode airspeed and/or heading data is also lost or not available, the DR function may not be capable of accurately tracking estimated position and, consequently, the system may display a path that is different than the actual movement of the aircraft. Estimated position information displayed by the G1000 through DR while there is no heading and/or airspeed data available should not be used for navigation.

DR Mode is inherently less accurate than the standard GPS/SBAS Mode due to the lack of satellite measurements needed to determine a position. Changes in wind speed and/or wind direction compound the relative inaccuracy of DR Mode. Because of this degraded accuracy, other navigation equipment must be relied upon for position awareness until GPS-derived position data is restored.

DR Mode is indicated on the G1000 by the appearance of the letters 'DR' superimposed in yellow over the 'own aircraft' symbol as shown in Figure 5-146. In addition, 'DR' is prominently displayed in yellow on the HSI slightly above and to the right of the aircraft symbol on the CDI as shown in Figure 5-146. The CDI deviation bar remains, but is removed from the display after 20 minutes in DR Mode. The autopilot will remain coupled in DR mode as long as the deviation is available (20 min.) Lastly, but at the same time, a 'GPS NAV LOST' alert message appears on the PFD. Normal navigation using GPS/SBAS source data resumes automatically once a valid GPS solution is restored.

As a result of operating in DR Mode, all GPS-derived data is computed based upon an estimated position and is displayed as yellow text on the display to denote degraded navigation source information as shown in Figure 5-146.

Also, while the G1000 is in DR Mode, the autopilot will remain coupled to GPS for up to 20 minutes. TAWS, Terrain-SVS, and Terrain Proximity are disabled. Additionally, the accuracy of all nearest information (airports, airspaces, and waypoints) is questionable. Finally, airspace alerts continue to function, but with degraded accuracy.

- SYSTEM OVERVIEW
- FLIGHT INSTRUMENTS
- EIS
- AUDIO PANEL & CNS
- FLIGHT MANAGEMENT
- HAZARD AVOIDANCE
- AFCS
- ADDITIONAL FEATURES
- APPENDICES
- INDEX

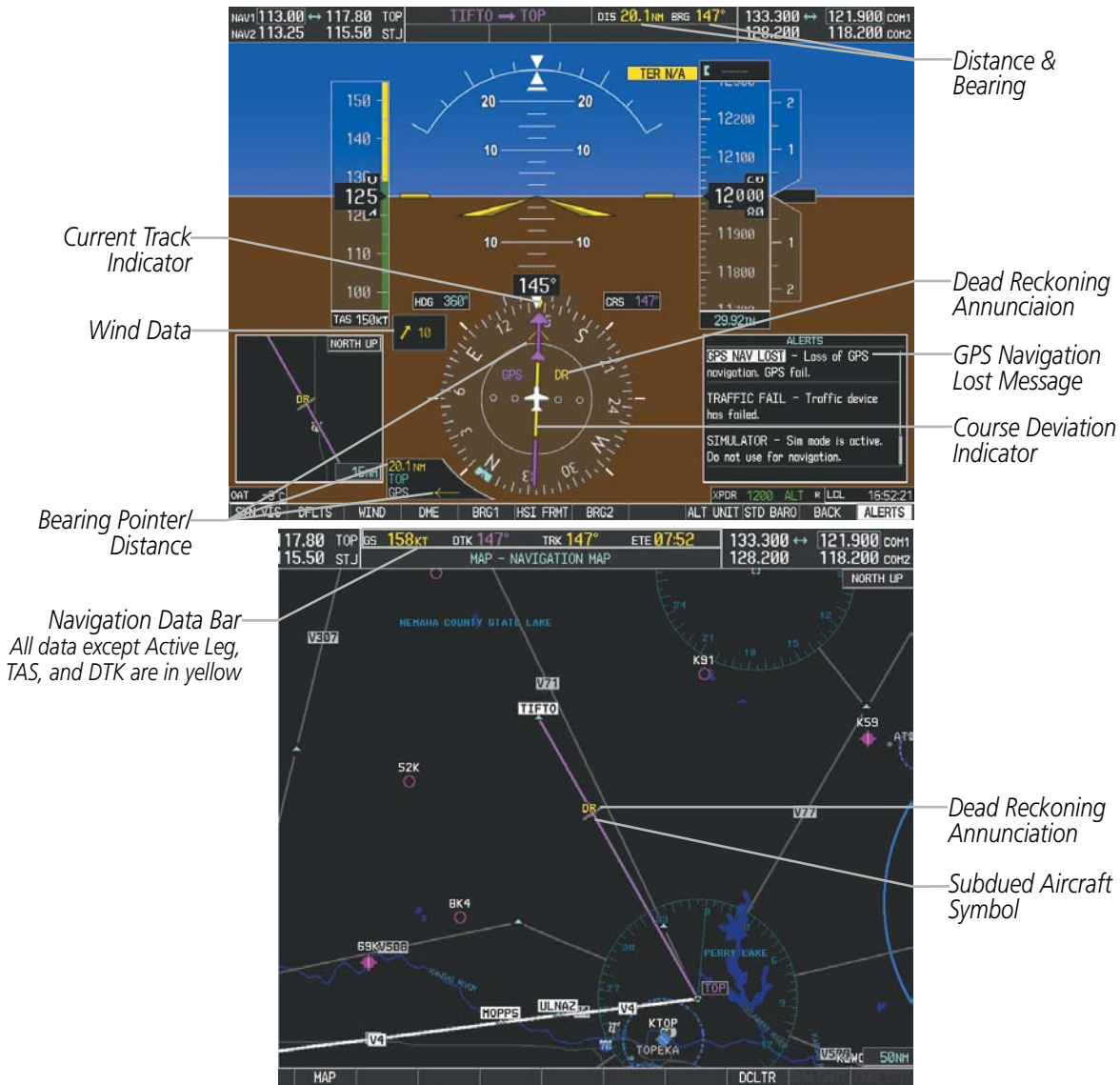

Figure 5-146 Dead Reckoning Mode - GPS Derived Data Shown in Yellow



NOTE: The Inset Map is removed from the PFD any time aircraft pitch is greater than +30° or less than -20°, or when a 65° bank angle is reached.

SECTION 6 HAZARD AVOIDANCE

Hazard avoidance features available for the G1000 are designed to aid situational awareness and provide advisory information with regard to potential hazards to flight safety associated with weather, terrain, and air traffic.

Weather

- GDL 69A XM WX Satellite Weather (Optional)
- GSR 56 Garmin Flight Data Services (GFDS) Worldwide Weather (Optional)
- GDL 90 Flight Information Service - Broadcast Weather (Optional)
- L-3 STORMSCOPE® WX-500 Series II Weather Mapping Sensor (Optional)

Terrain Avoidance

- Terrain Proximity
- Terrain-SVS (Standard with SVS Option)
- Terrain Awareness and Warning System-Class B (TAWS-B) (Optional)

Traffic

- Traffic Information Service (TIS)
- Garmin GTS 800 Traffic Advisory System (TAS) (Optional)
- Honeywell® KTA 870 Traffic Advisory System (TAS) (Optional)
- Automatic Dependent Surveillance - Broadcast (ADS-B) Traffic (Optional)

6.1 XM WX SATELLITE WEATHER



NOTE: XM WX Satellite Weather data provides information for avoiding hazardous weather. Do not use XM WX information to penetrate hazardous weather.

XM WX Satellite Weather is provided through the GDL 69A, a remote-mounted data-link satellite receiver. Received graphical weather information and associated text is displayed on the Multi Function Display (MFD) and the Primary Flight Display (PFD) Inset Map. The GDL 69A can also receive SiriusXM Satellite Radio entertainment services. Both weather data and entertainment programming operate in the S-band frequency range to provide continuous reception capabilities at any altitude throughout North America.

Services from SiriusXM are subscription-based. For more information on specific service packages, visit www.siriusxm.com.

ACTIVATING SERVICES

Before XM WX Satellite Weather can be used, the service must be activated. Service is activated by providing SiriusXM with coded IDs unique to the installed GDL 69A. SiriusXM Satellite Radio (audio) and XM WX Satellite Weather (data) services each have coded IDs. The Data and Audio Radio IDs must be provided to XM Satellite Radio to activate the weather service and entertainment subscriptions, respectively. These IDs are located on:

- The label on the back of the Data Link Receiver
- The XM Information Page on the MFD (Figure 6-1)
- The XM Satellite Radio Activation Instructions included with the unit (available at www.garmin.com, P/N 190-00355-04)

Contact the installer if the Audio and Data Radio IDs cannot be located.

SiriusXM uses the coded IDs to send an activation signal that allows the system to display weather data and/or entertainment programming provided through the GDL 69A.

Activating XM WX Satellite Weather and SiriusXM Satellite Radio services:

- 1) Contact SiriusXM Satellite Radio customer service using the phone number listed on the website. Follow the instructions provided by SiriusXM customer service.
- 2) Select the XM page in the Auxiliary Page Group.
- 3) Press the **INFO** Softkey to display the XM Information Page.
- 4) Verify that the desired services are activated.
- 5) Press the **LOCK** Softkey.
- 6) Turn the large **FMS** Knob to highlight 'YES'.
- 7) To complete activation, press the **ENT** Key.



Figure 6-1 XM Information Page

USING XM WX SATELLITE WEATHER PRODUCTS

The principal map for viewing XM WX Satellite Weather data is the Weather Data Link (XM) Page in the Map Page Group. This is the only G1000 map display capable of showing information for all available XM WX products.

Viewing the Weather Data Link (XM) Page:

- 1) Turn the large **FMS** Knob to select the Map Page Group.
- 2) Turn the small **FMS** Knob to select the Weather Data Link (XM, FIS-B, or GFDS) Page.
- 3) If the page title displays a weather datalink source other than 'XM', such as 'FIS-B' or 'GFDS', proceed to the following steps to change the weather datalink source.
- 4) Press the **MENU** Key.
- 5) Turn the small **FMS** Knob to select 'Display XM Weather' and press the **ENT** Key. The page title will display 'MAP - WEATHER DATA LINK (XM)' to indicate XM is now the selected weather datalink source.

- SYSTEM OVERVIEW
- FLIGHT INSTRUMENTS
- EIS
- AUDIO PANEL & CNS
- FLIGHT MANAGEMENT
- HAZARD AVOIDANCE
- AFCS
- ADDITIONAL FEATURES
- APPENDICES
- INDEX

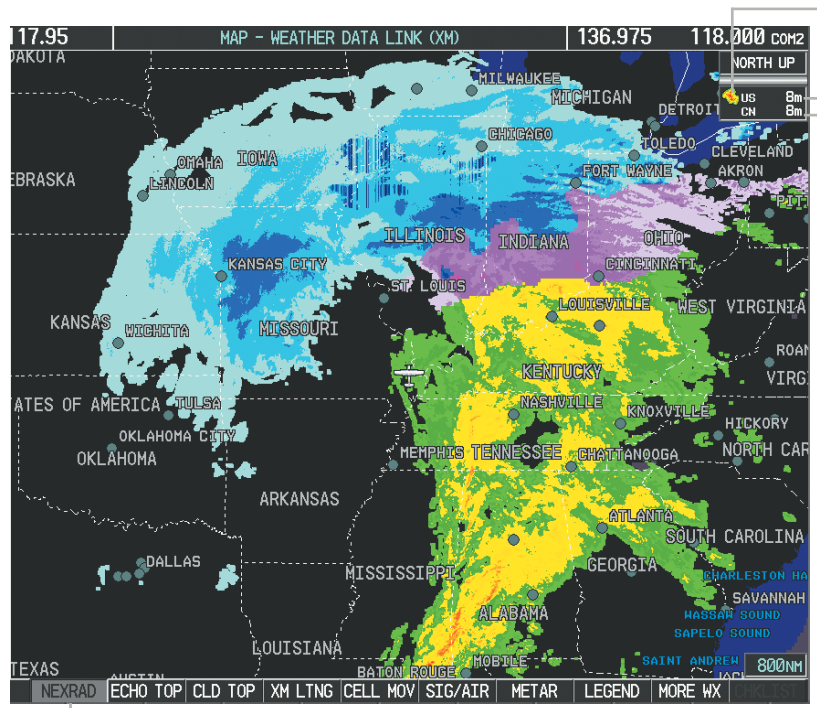

NEXRAD Weather Product Symbol

NEXRAD Weather Product Ages (US & Canada)

NEXRAD Weather Product Selected for Display

Figure 6-2 Weather Data Link (XM) Page

When an XM WX product is active on a MFD map, the age of the data is displayed on the screen to the right of the product symbol (Figure 6-2). The age of the product is based on the time difference between when the data was assembled on the ground and the current GPS time. Weather products are refreshed at specific intervals (defined in the **Refresh Rate** column in Table 6-1).

If for any reason, a weather product is not refreshed within the **Expiration Time** intervals (see Table 6-1), the data is considered expired and is removed from the display. This ensures the displayed data is consistent with the data XM WX services is currently transmitting. If more than half of the expiration time has elapsed, the color of the product age displayed changes to yellow. If no data is available for a weather product, 'N/A' is displayed next to the weather product symbol. If a weather product age is invalid, the system displays dashes next to the product symbol instead of a product age.

Table 6-1 shows the weather product symbols, the expiration times and the refresh rates. The refresh rate represents the interval at which XM WX services provides new signals that may or may not contain new weather data. It does not represent the rate at which weather data is updated or new content is received by the Data Link Receiver. Weather data is updated at intervals that are defined and controlled by SiriusXM and its data providers, and are subject to change.

















XM WX Satellite Weather Product	Symbol	Expiration Time (Minutes)	Refresh Rate (Minutes)
Next-generation Radar (NEXRAD)		30	5 (U.S.) 10 (Canada)
Cloud Top (CLD TOP)		60	15
Echo Top (ECHO TOP)		30	7.5
XM Lightning (LTNG)		30	5
Cell Movement (CELL MOV)		30	12
SIGMETs/AIRMETs (SIG/AIR)		60	12
Meteorological Aerodrome Report (METARs)		90	12
City Forecast (CITY)		60	12
Surface Analysis (SFC)		60	12
Freezing Levels (FRZ LVL)		60	12
Winds Aloft (WIND)		60	12
County Warnings (COUNTY)		60	5
Cyclone Warnings (CYCLONE)		60	12
Icing Potential (CIP and SLD) (ICNG)		90	22
Pilot Weather Report (PIREPs)		90	12
Air Report (AIREPs)		90	12
Turbulence (TURB)		180	12
Radar Coverage (RADAR CVRG)	no product image	30	5
Temporary Flight Restrictions (TFRs)	no product image	60	12
Terminal Aerodrome Reports (TAFs)	no product image	60	12

Table 6-1 XM WX Satellite Weather Product Symbols and Data Timing

Table 6-2 shows which XM WX products can be displayed (indicated with a '+' symbol) on specific maps.

XM WX Satellite Weather Product	PFD Inset Map	Navigation Map Page	Weather Data Link (XM) Page	Weather Information Page	AUX - Trip Planning Page	AUX - Video Page	Nearest Page Group	Flight Plan Pages
NEXRAD	+	+	+		+	+	+	+
Cloud Top (CLD TOP)			+					
Echo Top (ECHO TOP)			+					
XM Lightning (LTNG)	+	+	+		+	+	+	+
Cell Movement (CELL MOV)	+	+	+		+		+	+
SIGMETs/AIRMETs (SIG/AIR)			+					
METARs	+	+	+	+	+	+	+	+
City Forecast (CITY)			+					
Surface Analysis (SFC)			+					
Freezing Levels (FRZ LVL)			+					
Winds Aloft (WIND)		+*	+					
County Warnings (COUNTY)			+					
Cyclone Warnings (CYCLONE)			+					
Icing Potential (ICNG)			+					
PIREPs			+	+				
AIREPs			+	+				
Turbulence (TURB)			+					
Radar Coverage		+	+					
TFRs	+	+	+	+	+	+	+	+
TAFs			+	+				

* Winds Aloft Data displayed inside Profile View on the Navigation Map Page.

Table 6-2 Weather Product Display Maps

Softkeys control the display of weather information on most MFD pages and the PFD Inset Map. Figure 6-3 shows the weather product softkeys for the Weather Data Link (XM) Page. When a weather product is selected for display, the corresponding softkey label changes to gray to indicate the product is enabled.

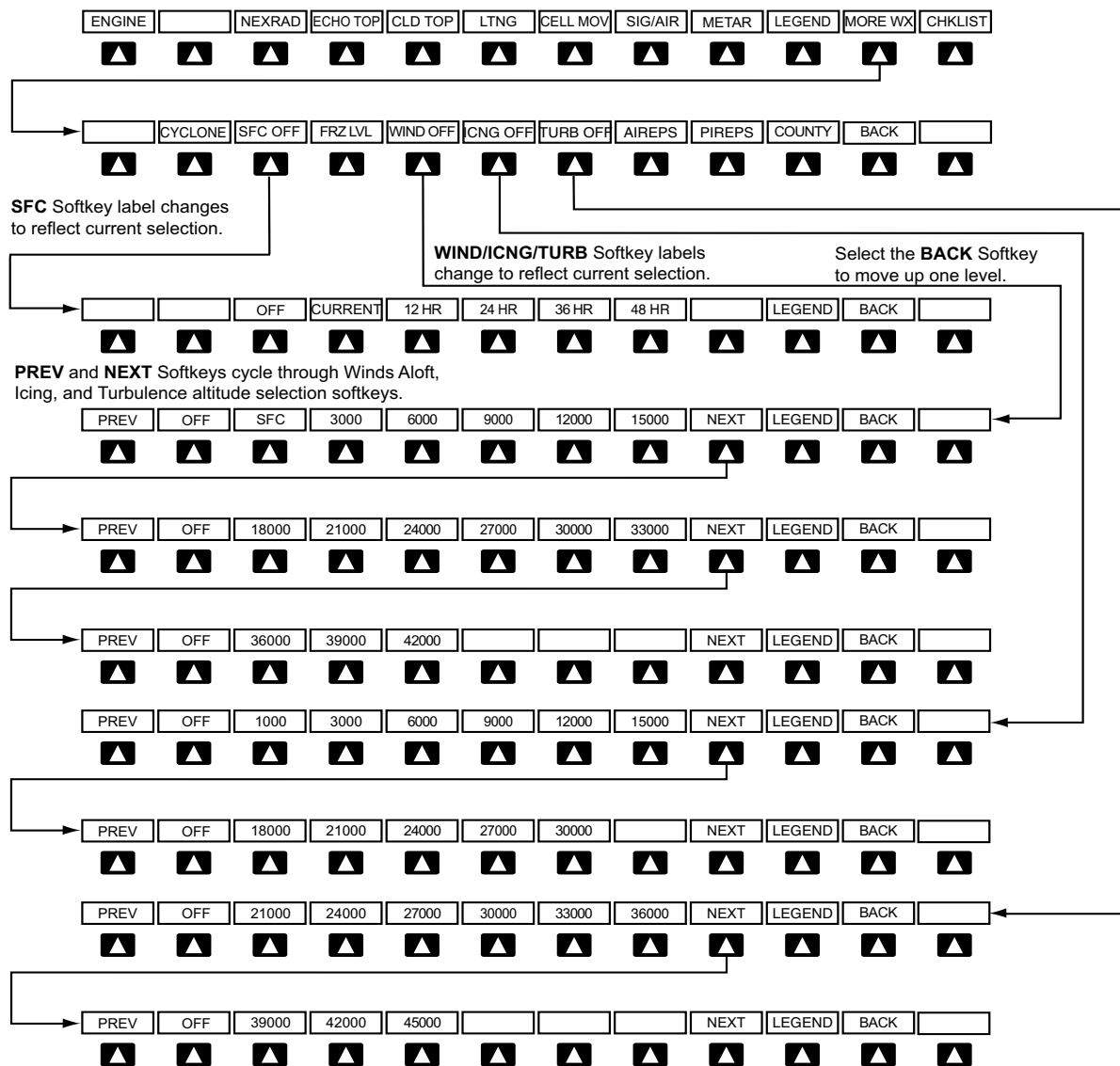

Figure 6-3 Weather Data Link (XM) Weather Product Softkeys

The setup menus for the Navigation Map Page and the Weather Data Link (XM) Page control the map range settings above which weather products data are decluttered from the display. If a map range larger than the weather product map range setting is selected, the weather product data is removed from the map. The menus also provide a means in addition to the softkeys for enabling/disabling display of weather products.

Setting up and customizing the Weather Data Link (XM) Page:

- 1) Select the Weather Data Link (XM) Page.
- 2) Press the **MENU** Key.
- 3) With 'Weather Setup' highlighted, press the **ENT** Key (Figure 6-4).
- 4) Turn the small **FMS** Knob to select 'PRODUCT GROUP 1' or 'PRODUCT GROUP 2', and press the **ENT** Key (Figure 6-5).
- 5) Turn the large **FMS** Knob or press the **ENT** Key to scroll through product selections.
- 6) Turn the small **FMS** Knob to scroll through options for each product (ON/OFF, range settings, etc.).
- 7) Press the **ENT** Key to select an option.
- 8) Press the **FMS** Knob or **CLR** Key to return to the Weather Data Link (XM) Page with the changed settings.



Figure 6-4 Weather Data Link (XM) Page Menu

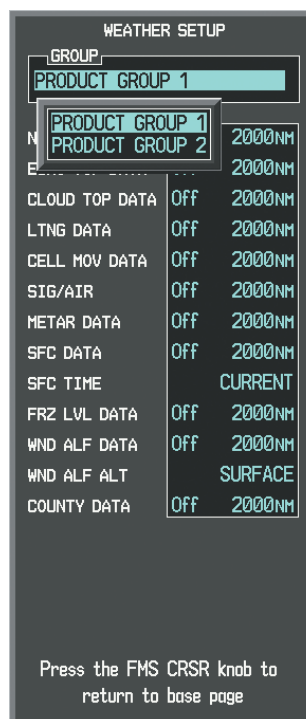

Figure 6-5 Weather Data Link Page Setup Menu

If optional GSR 56 Garmin Flight Data Services (GFDS) Worldwide Weather or GDL 90 Flight Information Service - Broadcast weather data has also been enabled, customizing the display settings for the corresponding weather products shown in Table 6-3 will result in identical settings for all services.

XM WX Satellite Weather Product	GFDS Worldwide Weather Product	FIS-B Weather Product
Next-generation Radar (NEXRAD)	Precipitation (PRECIP)	Precipitation (PRECIP)
Cloud Top (CLD TOP)	Infrared Satellite (IR SAT)	Not Available
XM Lightning (XM LTNG)	GFDS Lightning (DL LTNG)	Not Available
SIGMETs/AIRMETs (SIG/AIR)	SIGMETs/AIRMETs (SIG/AIR)	Not Available
Meteorological Aerodrome Report (METARs)	Meteorological Aerodrome Report (METARs)	Meteorological Aerodrome Report (METARs)
Winds Aloft (WIND)	Winds Aloft (WIND)	Not Available
Pilot Weather Report (PIREPs)	Pilot Weather Report (PIREPs)	Not Available

Table 6-3 Weather Datalink Settings Shared for Multiple Datalink Sources

Restoring default Weather Data Link (XM) Page settings:

- 1) Select the Weather Data Link (XM) Page.
- 2) Press the **MENU** Key.
- 3) With 'Weather Setup' highlighted, press the **ENT** Key.
- 4) Press the **MENU** Key.
- 5) Highlight the desired option to restore defaults (for all or for selection), and press the **ENT** Key.

Weather displayed on Pages other than the Weather Data Link Page use settings based on those selected for the Navigation Map Page.

Setting up and customizing weather data for the Navigation Map Page:

- 1) Select the Navigation Map Page.
- 2) Press the **MENU** Key.
- 3) With 'Map Setup' highlighted, press the **ENT** Key (Figure 6-6).
- 4) Turn the small **FMS** Knob to select the 'Weather' Group and press the **ENT** Key (Figure 6-7).
- 5) Turn the large **FMS** Knob or press the **ENT** Key to scroll through product selections (Figure 6-8).
- 6) Turn the small **FMS** Knob to scroll through options for each product (ON/OFF, range settings).
- 7) Press the **ENT** Key to select an option.
- 8) Press the **FMS** Knob or **CLR** Key to return to the Navigation Map Page with the changed settings.

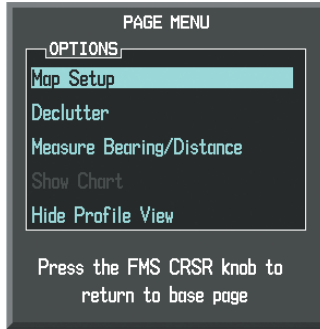

Figure 6-6 Navigation Map Page Menu

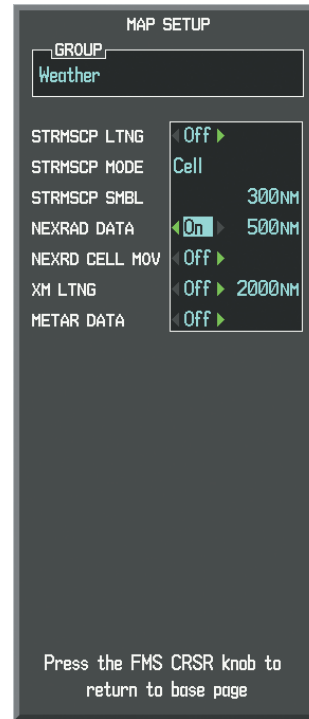

Figure 6-8 Navigation Map Page Setup Menu, Weather Group



Figure 6-7 Navigation Map Page Setup Menu

When an XM WX product is enabled for display on the PFD Inset Map, the weather product information box (with the product icon and age) can be displayed inside the PFD Inset Map.

Viewing the weather product information box on the PFD Inset Map:

- 1) On the PFD, press the **INSET** Softkey.
- 2) Press the **WX LGND** Softkey.
- 3) To remove the weather product information box, press the **WX LGND** Softkey again.

Each active weather product has an associated legend which can be displayed on the Weather Data Link (XM) Page.

Viewing legends for displayed weather products (on the Weather Data Link (XM) Page):

- 1) Select the Weather Data Link (XM) Page.
- 2) Press the **LEGEND** Softkey to display the legends for the displayed weather products.

Or:

- a) Press the **MENU** Key.
- b) Select 'Weather Legend' and press the **ENT** Key.
- 3) Turn the **FMS** Knob to scroll through the legends.
- 4) To remove the Legend Window, press the **LEGEND** Softkey, the **ENT** or the **CLR** Key, or press the **FMS** Knob.

Viewing legends for displayed weather products (on the Navigation Map Page):

- 1) Select the Navigation Map Page.
- 2) Press the **MAP** Softkey.
- 3) Press the **LEGEND** Softkey (available if one or more XM WX products are enabled for display).
- 4) To remove the Legend Window, press the **LEGEND** Softkey, the **ENT** or the **CLR** Key, or press the **FMS** Knob.

Additional information about the following can be displayed by panning over the display on the map:

- Echo Tops
- Cell Movement
- SIGMETs
- AIRMETs
- METARs
- County Warnings
- TFRs
- PIREPs
- AIREPs

The map panning feature is enabled by pressing the **RANGE** Knob. The map range is adjusted by turning the **RANGE** Knob. If the map range is adjusted while panning is enabled, the map is re-centered on the Map Pointer.

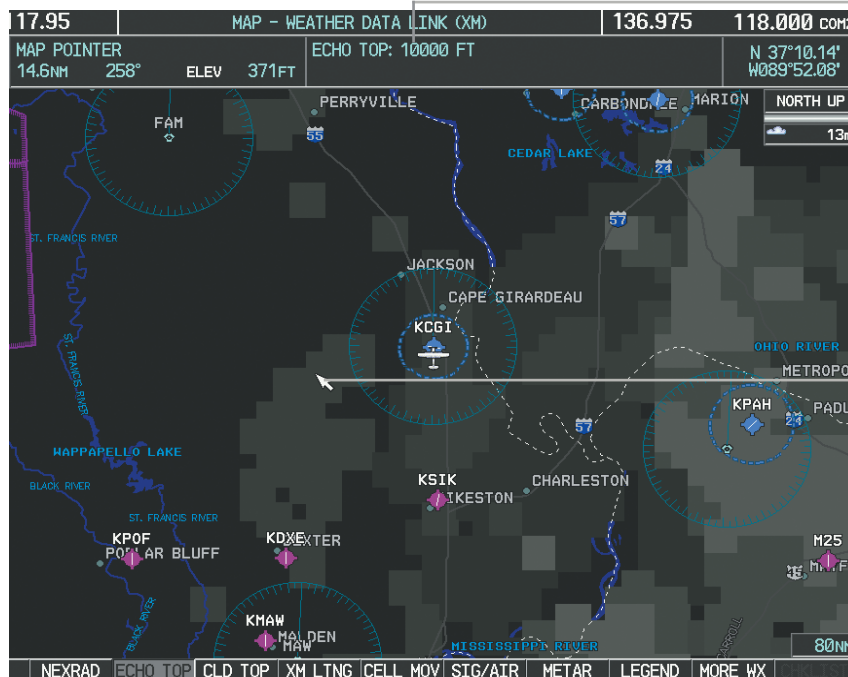

Additional Information on Weather Feature Selected with Map Pointer

Echo Top Data Selected with Map Pointer

Figure 6-9 Panning on the Weather Data Link Page

NEXRAD



NOTE: NEXRAD data cannot be displayed at the same time as terrain, echo tops, turbulence, or icing data, is displayed.

WSR-88D, or NEXRAD (NEXt-generation RADar), is a network of 158 high-resolution Doppler radar systems that are operated by the National Weather Service (NWS). NEXRAD data provides centralized meteorological information for the continental United States and selected overseas locations. The maximum range of a single NEXRAD radar site is 250 nm. In addition to a wide array of services, the NEXRAD network provides important information about severe weather and air traffic safety.

NEXRAD data is not real-time. The lapsed time between collection, processing, and dissemination of NEXRAD images can be significant and may not reflect the current radar synopsis. Due to the inherent delays and the relative age of the data, it should be used for long-range planning purposes only. Never use NEXRAD data or any radar data to penetrate hazardous weather. Rather, use it in an early-warning capacity of pre-departure and enroute evaluation.

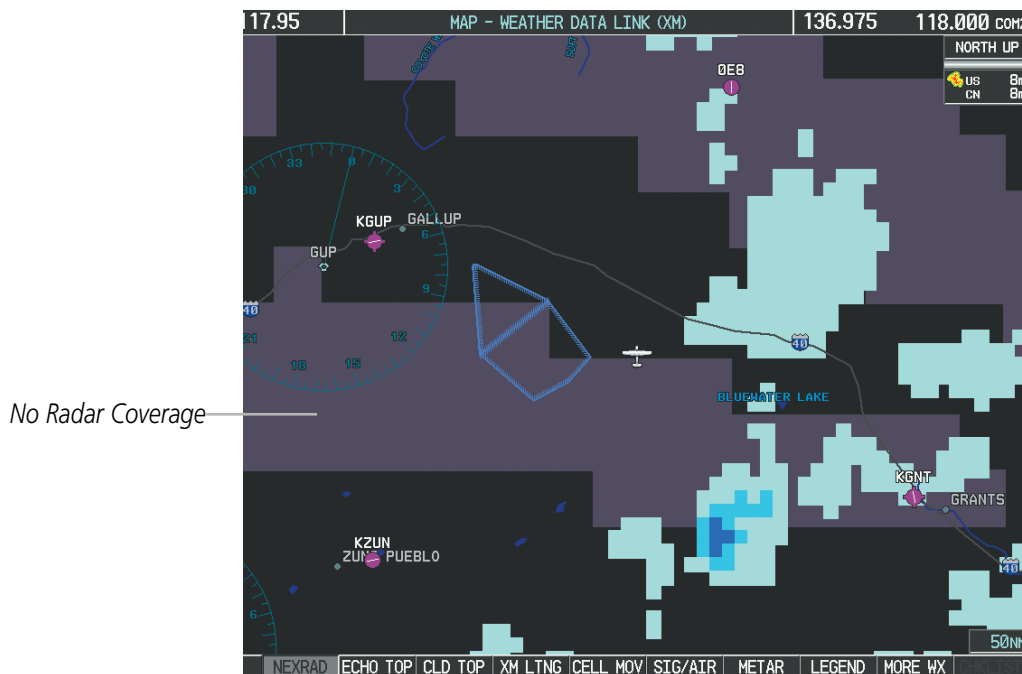

Figure 6-10 NEXRAD Data on the Weather Data Link Page

NEXRAD data can be displayed on the following maps:

- PFD Inset Map
- Navigation Map Page
- Weather Data Link Page
- Airport Information Page
- Trip Planning Page
- Nearest Pages
- Flight Plan Pages

Displaying NEXRAD weather information:

- 1) Press the **MAP** Softkey (for the PFD Inset Map, press the **INSET** Softkey). This step is not necessary on the Weather Data Link (XM) Page.
- 2) Press the **NEXRAD** Softkey.

Composite data from all the NEXRAD radar sites in the United States is shown. This data is composed of the maximum reflectivity from the individual radar sweeps. The display of the information is color-coded to indicate the weather severity level. All weather product legends can be viewed on the Weather Data Link (XM) Page. For the NEXRAD legend (Figure 6-11), press the **LEGEND** Softkey when NEXRAD is selected for display.

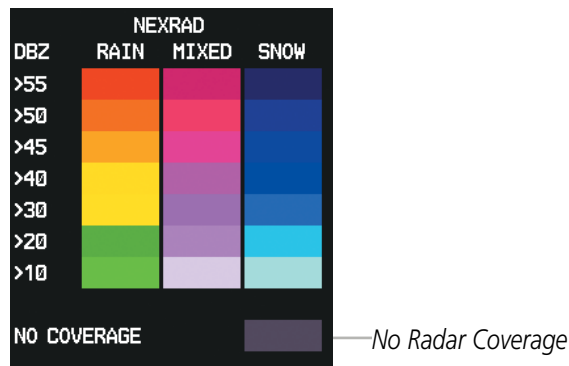

Figure 6-11 NEXRAD Data with Legend

The display of no radar coverage is always active when either NEXRAD or Echo Coverage is selected. Areas where NEXRAD radar coverage and Echo Tops information is not currently available or is not being collected are indicated in a gray shade of purple (Figure 6-11).

REFLECTIVITY

Reflectivity is the amount of transmitted power returned to the radar receiver. Colors on the NEXRAD display are directly correlative to the level of detected reflectivity. Reflectivity as it relates to hazardous weather can be very complex.

The role of radar is essentially to detect moisture in the atmosphere. Simply put, certain types of weather reflect radar better than others. The intensity of a radar reflection is not necessarily an indication of the weather hazard level. For instance, wet hail returns a strong radar reflection, while dry hail does not. Both wet and dry hail can be extremely hazardous.

The different NEXRAD echo intensities are measured in decibels (dB) relative to reflectivity (Z). NEXRAD measures the radar reflectivity ratio, or the energy reflected *back to* the radar receiver (designated by the letter Z). The value of Z increases as the returned signal strength increases.

SYSTEM OVERVIEW

FLIGHT INSTRUMENTS

EIS

AUDIO PANEL & CNS

FLIGHT MANAGEMENT

HAZARD AVOIDANCE

AFCS

ADDITIONAL FEATURES

APPENDICES

INDEX

NEXRAD LIMITATIONS

NEXRAD radar images may have certain limitations:

- NEXRAD base reflectivity does not provide sufficient information to determine cloud layers or precipitation characteristics (wet hail vs. rain). For example, it is not possible to distinguish between wet snow, wet hail, and rain.
- NEXRAD base reflectivity is sampled at the minimum antenna elevation angle. An individual NEXRAD site cannot depict high altitude storms at close ranges. It has no information about storms directly over the site.
- When zoomed in to a range of 30 nm, each square block on the display represents an area of four square kilometers. The intensity level reflected by each square represents the *highest* level of NEXRAD data sampled within the area (Figure 6-12).
- Unknown precipitation occurring below 52°N is displayed as rain.

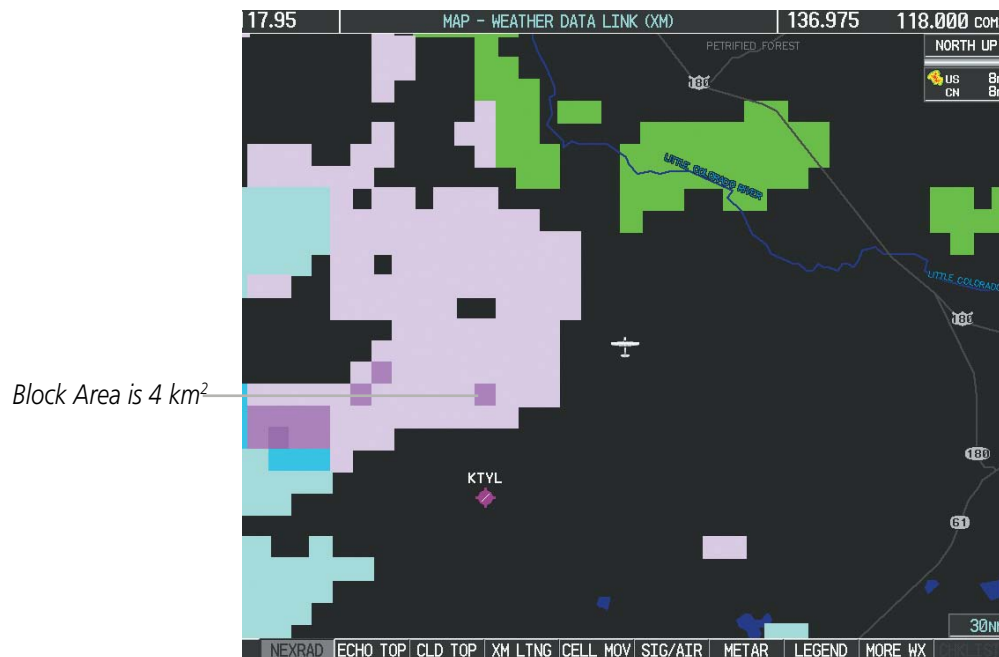

Figure 6-12 NEXRAD Data - Zoomed

The following may cause abnormalities in displayed NEXRAD radar images:

- Ground clutter
- Strokes and spurious radar data
- Sun strobes (when the radar antenna points directly at the sun)
- Interference from buildings or mountains, which may cause shadows
- Metallic dust from military aircraft, which can cause alterations in radar scans

NEXRAD LIMITATIONS (CANADA)

- Radar coverage extends to 55°N.
- Any precipitation displayed between 52°N and 55°N is shown as mixed precipitation, regardless of precipitation type.

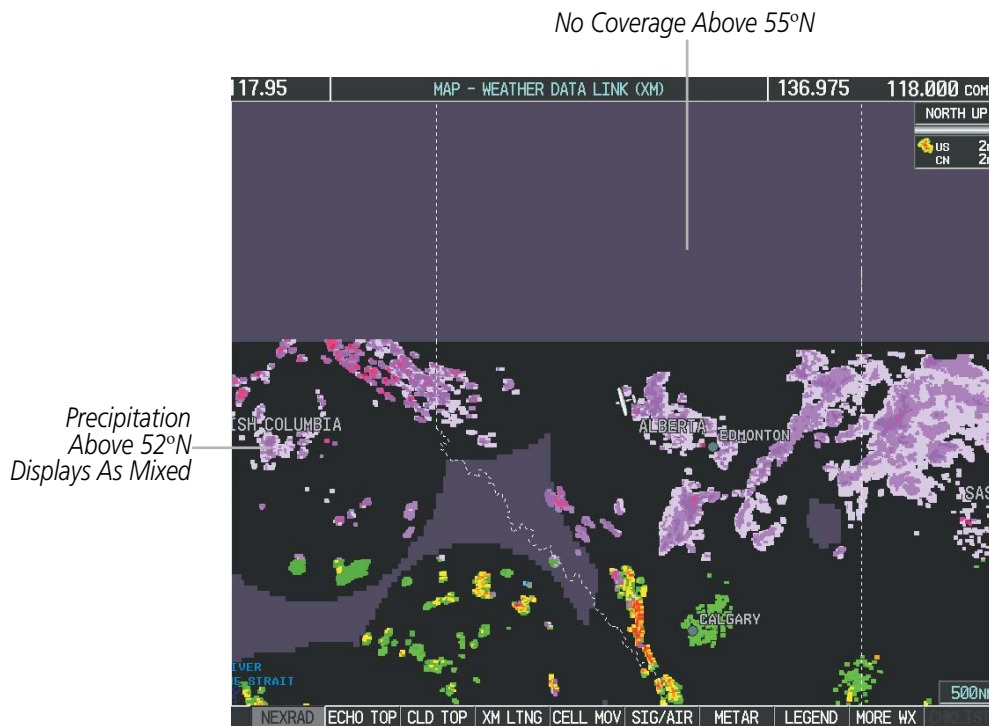

Figure 6-13 NEXRAD Data - Canada

ECHO TOPS



NOTE: Echo Tops cannot be displayed with Cloud Tops or NEXRAD data.

Echo Tops data (Figure 6-14) shows the location, elevation, and direction of the highest radar echo. The highest radar echo does not indicate the top of a storm or clouds; rather it indicates the highest altitude at which precipitation is detected. Information is derived from NEXRAD data.

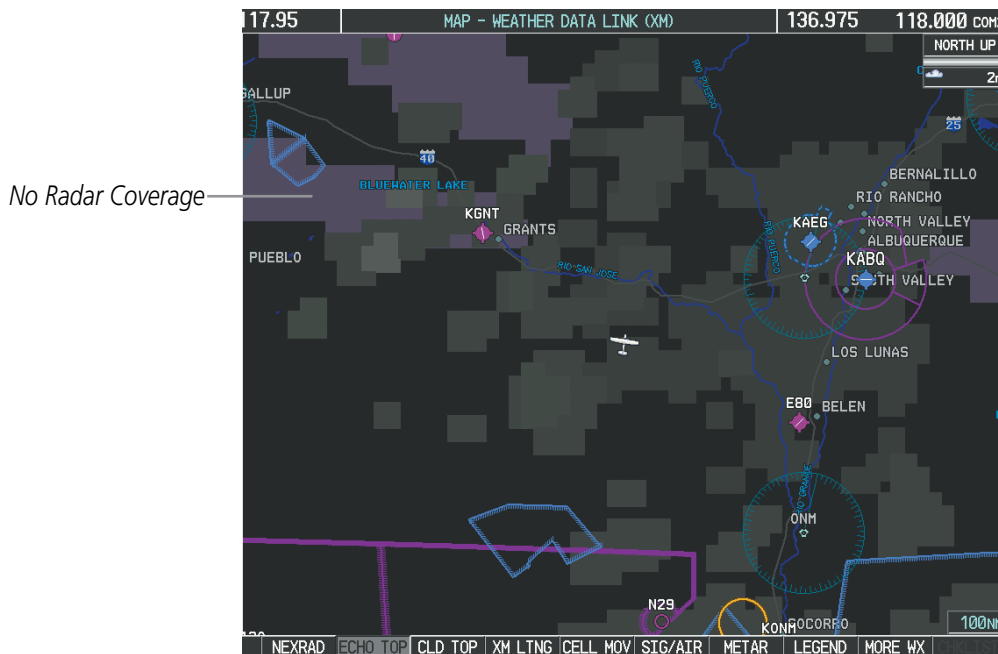

Figure 6-14 Echo Tops Data

Displaying Echo Tops information:

- 1) Select the Weather Data Link (XM) Page.
- 2) Press the **ECHO TOP** Softkey.

To display the Echo Tops legend (Figure 6-15), press the **LEGEND** Softkey when Echo Tops is selected for display. Since Echo Tops and Cloud Tops use the same color scaling to represent altitude, display of these weather products is mutually exclusive. When Echo Tops is activated, NEXRAD and Cloud Tops data are removed.

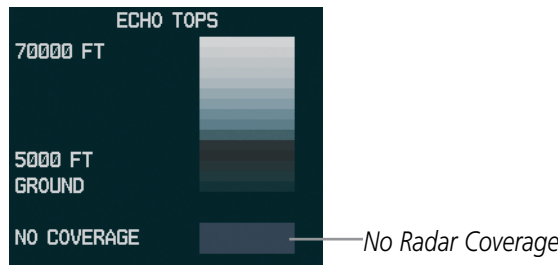

Figure 6-15 Echo Tops Legend

The display of radar coverage is always active when either NEXRAD or Echo Tops is selected. Areas where NEXRAD radar coverage and Echo Tops information is not currently available or is not being collected are indicated in gray shade of purple (Figure 6-15).

CLOUD TOPS



NOTE: *Cloud Tops and Echo Tops cannot be displayed at the same time.*

Cloud Tops data (Figure 6-16) depicts cloud top altitudes as determined from satellite imagery.

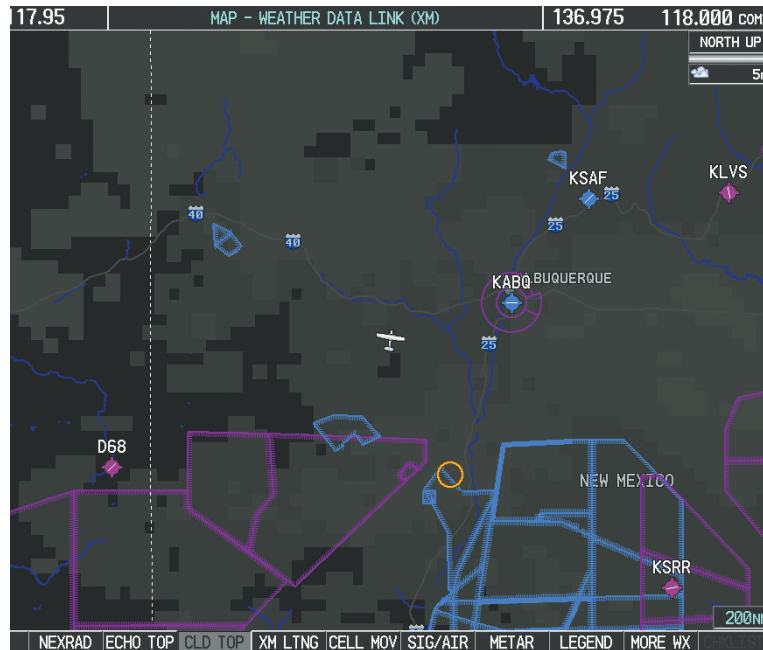

Figure 6-16 Cloud Tops Data

Displaying Cloud Tops information:

- 1) Select the Weather Data Link (XM) Page.
- 2) Press the **CLD TOP** Softkey.

To display the Cloud Tops legend (Figure 6-17), press the **LEGEND** Softkey when Cloud Tops is selected for display. Since Cloud Tops and Echo Tops use the same color scaling to represent altitude, display of these weather products is mutually exclusive. When Cloud Tops is activated, Echo Tops data is removed.

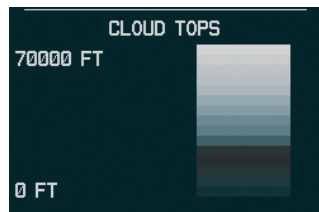

Figure 6-17 Cloud Tops Legend

XM LIGHTNING



NOTE: XM Lightning cannot be displayed at the same time as optional Stormscope® lightning data.

Lightning data (Figure 6-18) shows the approximate location of cloud-to-ground lightning strikes. A strike icon represents a strike that has occurred within a two-kilometer region. The exact location of the lightning strike is not displayed.

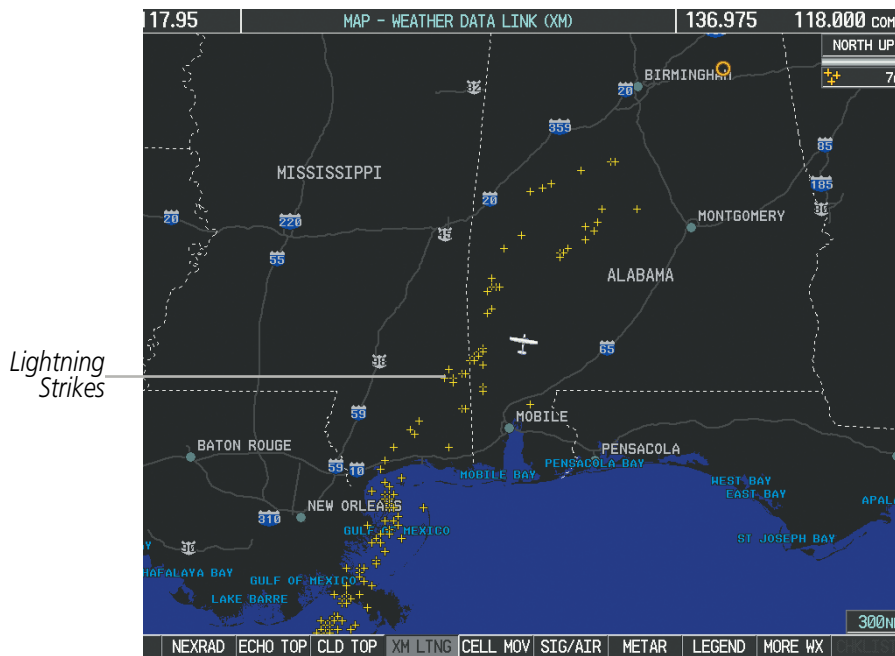

Figure 6-18 Lightning Data

XM Lightning data displays on the following maps:

- PFD Inset Map
- Navigation Map Page
- Weather Data Link Page
- Trip Planning Page
- Nearest Pages
- Flight Plan Pages

Displaying XM Lightning information:

- 1) Press the **MAP** Softkey (for the PFD Inset Map, press the **INSET** Softkey). This step is not necessary on the Weather Data Link (XM) Page.
- 2) Press the **XM LTNG** Softkey (**LTNG** Softkey on the Weather Data Link (XM) Page).

To display the XM Lightning legend on the Weather Data Link (XM) Page (Figure 6-19), press the **LEGEND** Softkey when XM Lightning is selected for display.

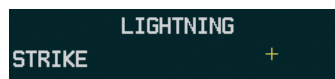

Figure 6-19 Lightning Legend

CELL MOVEMENT

Cell Movement data (Figure 6-20) shows the location and movement of storm cells as identified by the ground-based system. Cells are represented by yellow squares, with direction of movement indicated with short, orange arrows.



Figure 6-20 Cell Movement Data

On most applicable maps, Cell Movement data is selected for display along with NEXRAD. On the Weather Data Link (XM) Page, Cell Movement data can be selected independently. Cell Movement data can be displayed on the following maps:

- PFD Inset Map
- Navigation Map
- AUX - Trip Planning Page
- Nearest Pages

Displaying Cell Movement information:

- 1) Press the **MAP** Softkey (for the PFD Inset Map, press the **INSET** Softkey). This step is not necessary on the Weather Data Link (XM) Page.
- 2) Press the **NEXRAD** Softkey (**CEL MOV** Softkey on the Weather Data Link (XM) Page). For Cell Movement to be displayed on maps other than the Weather Data Link (XM) Page, Cell Movement must be turned on in the Navigation Map Setup Menu (see "Setting Up XM Satellite Weather").

To display the Cell Movement legend on the Weather Data Link (XM) Page, (Figure 6-21), press the **LEGEND** Softkey when Cell Movement is selected for display.

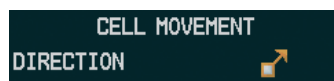

Figure 6-21 Cell Movement Legend

SIGMETS AND AIRMETS

SIGMETs (SIGnificant METeorological Information) and AIRMETs (AIRmen’s METeorological Information) are broadcast for potentially hazardous weather. A Convective SIGMET is issued for hazardous convective weather. A localized SIGMET is a significant weather condition occurring at a localized geographical position.

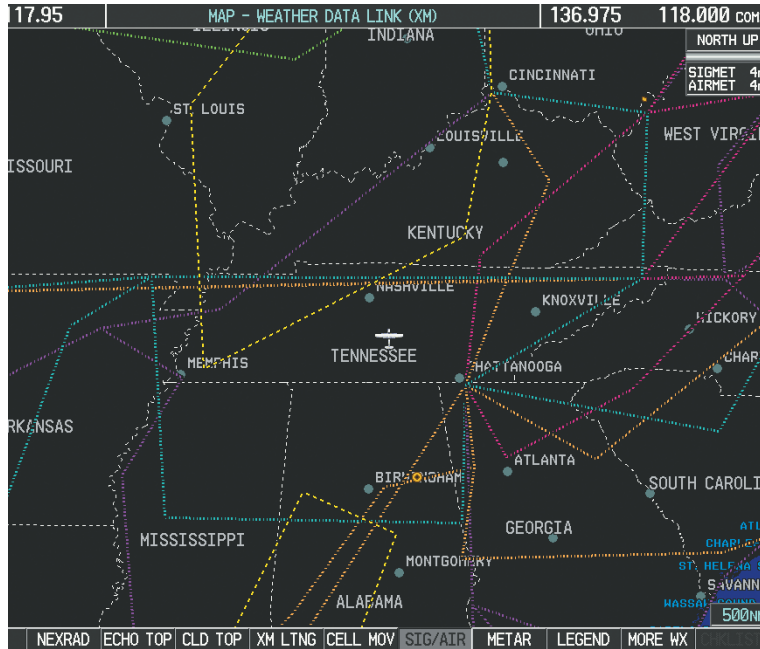

Figure 6-22 SIGMET/AIRMET Data

Displaying SIGMETs and AIRMETs:

- 1) Select the Weather Data Link (XM) Page.
- 2) Press the **SIG/AIR** Softkey.
- 3) To view the text of the SIGMET or AIRMET, press the **RANGE** Knob and move the Map Pointer over the icon.
- 4) Press the **ENT** key. Figure 6-23 shows sample SIGMET text.

To display the SIGMET and AIRMET legend (Figure 6-24), press the **LEGEND** Softkey when SIGMETs and AIRMETs are selected for display.

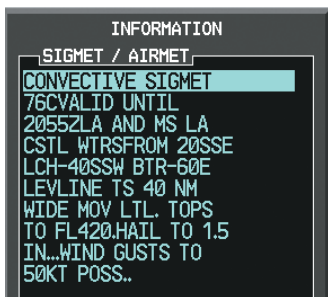

Figure 6-23 Sample SIGMET Text



Figure 6-24 SIGMET/AIRMET Legend

METARS AND TAFS

NOTE: Atmospheric pressure as reported for METARs is given in hectopascals (hPa), except for in the United States, where it is reported in inches of mercury (in Hg). Temperatures are reported in Celsius.

NOTE: METAR information is only displayed within the installed navigation database service area.

METARs (METEorological Aerodrome Reports) typically contain information about the temperature, dewpoint, wind, precipitation, cloud cover, cloud heights, visibility, and barometric pressure at an airport or observation station. They can also contain information on precipitation amounts, lightning, and other critical data. METARs reflect hourly observations; non-routine updates include the code “SPECI” in the report. METARs are shown as colored flags at airports that provide them.



Figure 6-25 METAR Flags on the Weather Data Link Page

TAFs (Terminal Aerodrome Forecasts) are weather predictions for specific airports within a 24- hour period, and may span up to 36 hours. TAFs typically include forecast wind, visibility, weather phenomena, and sky conditions using METAR codes.

METAR and TAF text are displayed on the Weather Information Page. METAR data is displayed first in a decoded fashion, then as raw text. TAF information is displayed only in its raw form when it is available

Displaying METAR and TAF text:

- 1) On the Weather Data Link (XM) Page, press the **METAR** Softkey.
- 2) Press the **RANGE** Knob and pan to the desired airport.
- 3) Press the **ENT** Key. The Weather Information Page is shown with METAR and TAF text.
- 4) Use the **FMS** Knob or the **ENT** Key to scroll through the METAR and TAF text. METAR text must be completely scrolled through before scrolling through the TAF text.

- 5) Press the **FMS** Knob or the **CLR** Key to return to the Weather Data Link (XM) Page.
Or:
 - 1) Select the Weather Information Page.
 - a) Turn the large **FMS** Knob to select the Waypoint Page Group.
 - b) Press the **WX** Softkey to select the Weather Information Page.
 - 2) Press the **FMS** Knob to display the cursor.
 - 3) Use the **FMS** Knob to enter the desired airport and press the **ENT** Key.
 - 4) Use the **FMS** Knob or the **ENT** Key to scroll through the METAR and TAF text. Note that the METAR text must be completely scrolled through before scrolling through the TAF text.

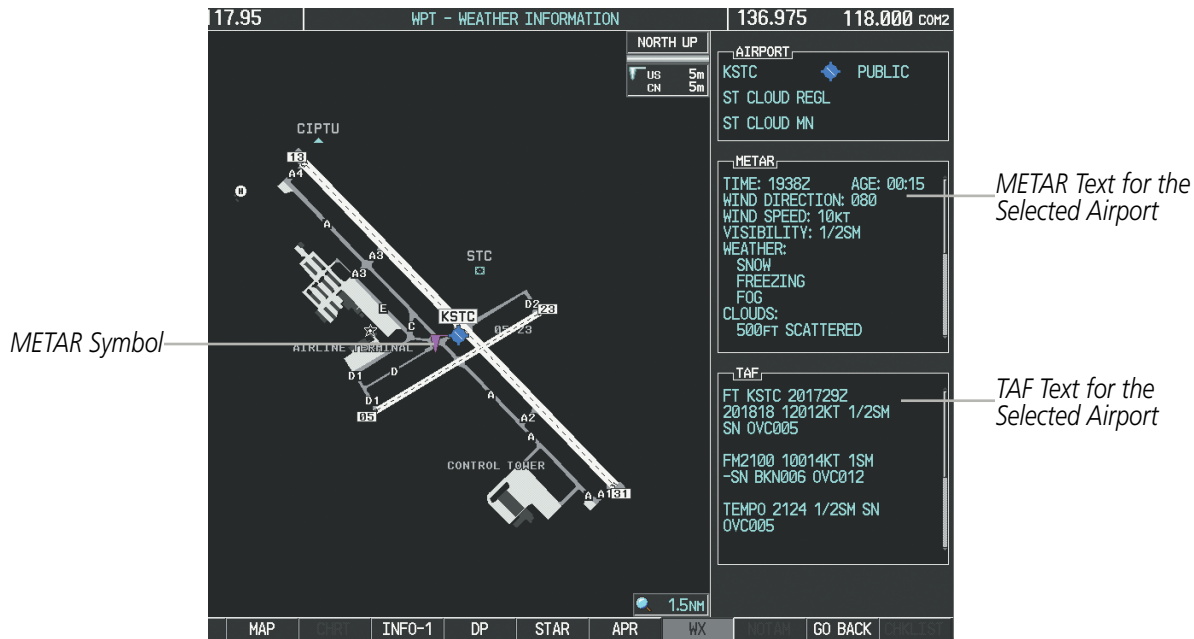

Figure 6-26 METAR and TAF Text on the Weather Information Page

To display the METAR legend on the Weather Data Link (XM) Page (Figure 6-27), press the **LEGEND** Softkey when METARs are selected for display.

The METAR flag color is determined by the information in the METAR text. A gray METAR flag is displayed when the METAR text does not contain adequate information.



Figure 6-27 METAR Legend

SURFACE ANALYSIS AND CITY FORECAST



NOTE: Surface Analysis and City Forecast data are displayed only within the installed Aviation Database service area.

Surface Analysis and City Forecast information is available for current and forecast weather conditions. Forecasts are available for intervals of 12, 24, 36, and 48 hours.

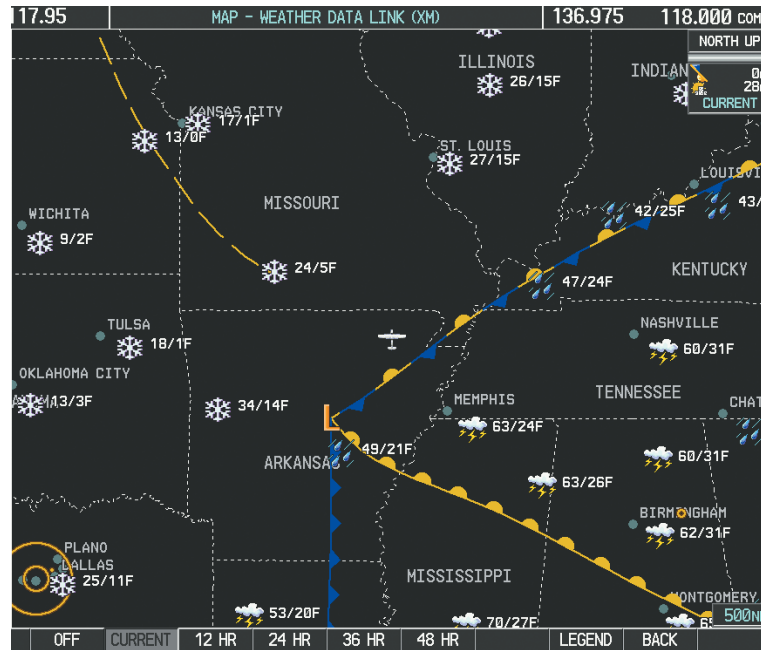

Figure 6-28 Current Surface Analysis Data

Displaying Surface Analysis and City Forecast information:

- 1) Select the Weather Data Link (XM) Page.
- 2) Press the **MORE WX** Softkey.
- 3) Press the **SFC** Softkey.
- 4) Select the desired forecast time: **CURRENT**, **12 HR**, **24 HR**, **36 HR**, or **48 HR**. The **SFC** Softkey label changes to reflect the forecast time selected.

To display the Surface Analysis and City Forecast legend (Figure 6-29), press the **LEGEND** Softkey when Surface Analysis and City Forecast are selected to be displayed.

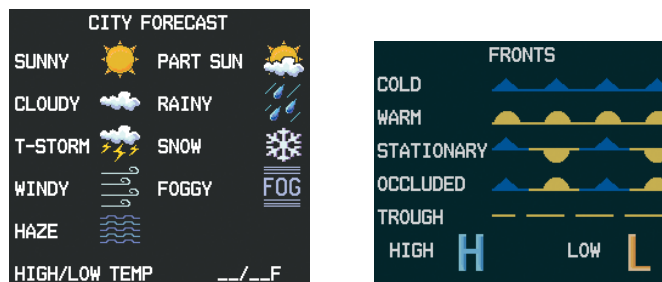

Figure 6-29 Surface Analysis Legend

FREEZING LEVELS

Freezing Level data shows the color-coded contour lines for the altitude and location at which the first isotherm is found (Figure 6-30). When no data is displayed for a given altitude, the data for that altitude has not been received, or is out of date and has been removed from the display. New data appears at the next update.

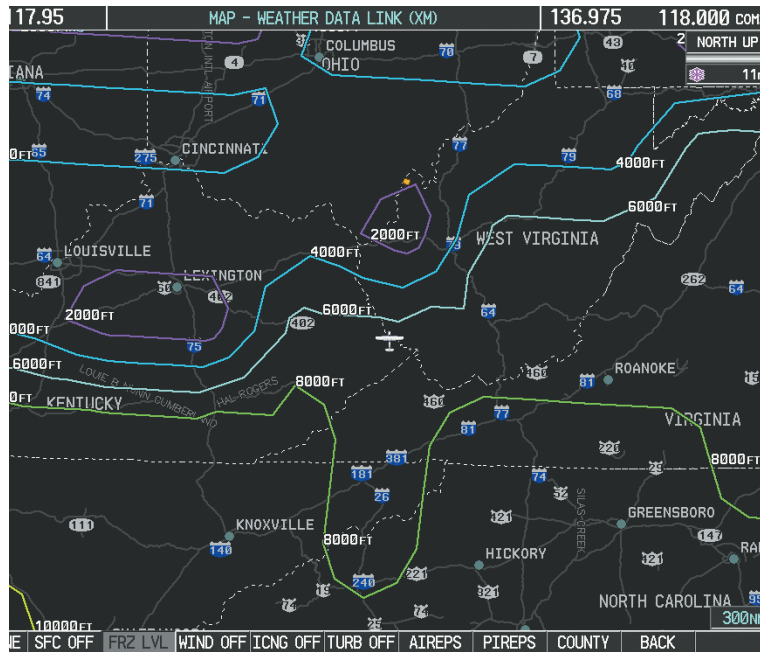

Figure 6-30 Freezing Level Data

Displaying Freezing Level information:

- 1) Select the Weather Data Link (XM) Page.
- 2) Press the **MORE WX** Softkey.
- 3) Press the **FRZ LVL** Softkey.

To display the Freezing Level legend (Figure 6-31), press the **LEGEND** Softkey when Freezing Level data is selected to be displayed.



Figure 6-31 Freezing Level Legend

WINDS ALOFT

Winds Aloft data (Figure 6-32) shows the forecasted wind speed and direction at the surface and at selected altitudes. Altitude can be displayed in 3,000-foot increments from the surface up to 42,000 feet MSL.

Displaying Winds Aloft data:

- 1) Select the Weather Data Link (XM) Page.
- 2) Press the **MORE WX** Softkey.
- 3) Press the **WIND** Softkey.
- 4) Select the desired altitude level: SFC (surface) up to 42,000 feet. Press the **NEXT** or **PREV** Softkey to cycle through the altitude softkeys. The **WIND** Softkey label changes to reflect the altitude selected.



Figure 6-32 Winds Aloft Data at 9,000 Feet

To display the Winds Aloft legend (Figure 6-33), press the **LEGEND** Softkey when Winds Aloft is selected for display.

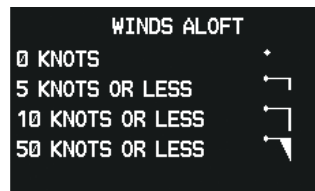

Figure 6-33 Winds Aloft Data with Legend

Headwind and tailwind components aloft are available inside the Profile View on the Navigation Map Page (Figure 6-34). The displayed components are relative to current aircraft altitude and track, but not to aircraft speed.



Figure 6-34 Navigation Map Page with Winds Aloft Data on Profile View

Arrows pointing to the left indicate headwind components; tailwind component arrows point to the right, as shown in Table 6-4.

Headwind Symbol	Tailwind Symbol	Headwind/Tailwind Component
None	None	Less than 5 knots
		5 knots
		10 knots
		50 knots

Table 6-4 Profile View Headwind/Tailwind Component Symbols

Showing/Hiding Profile View (containing winds aloft data)

- 1) Select the Navigation Map Page.
- 2) Press the **MAP** Softkey.
- 3) Press the **PROFILE** Softkey.

Or:

- 1) Press the **MENU** Key.
- 2) Turn the large FMS Knob to highlight 'Show Profile View' or 'Hide Profile View' (choice dependent on current state) and press the **ENT** Key.

Winds Aloft data inside the Profile View is enabled by default when the Profile View is displayed on the Navigation Map Page. This behavior can be changed on the Navigation Map Page.

Enabling/disabling winds aloft data display in Profile View:

- 1) Select the Navigation Map Page.
- 2) Press the **MENU** Key.
- 3) With Map Setup highlighted, press the **ENT** Key (Figure 6-35).
- 4) Turn the small **FMS** Knob to select the Profile Group and press the **ENT** Key (Figure 6-36).
- 5) Turn the large **FMS** Knob to select 'Profile Winds' (Figure 6-37).
- 6) Turn the small **FMS** Knob to select 'On' or 'Off'.
- 7) Press the **FMS** Knob or **CLR** Key to return to the Navigation Map Page with the changed settings.



Figure 6-35 Navigation Map Page Menu

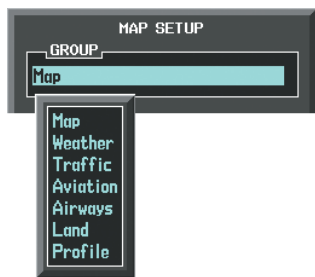

Figure 6-36 Navigation Map Page Setup Menu



Figure 6-37 Navigation Map Page Setup Menu, Weather Group

COUNTY WARNINGS

County data (Figure 6-38) provides specific public awareness and protection weather warnings from the National Weather Service (NWS). This can include information on tornadoes, severe thunderstorms, and flood conditions.

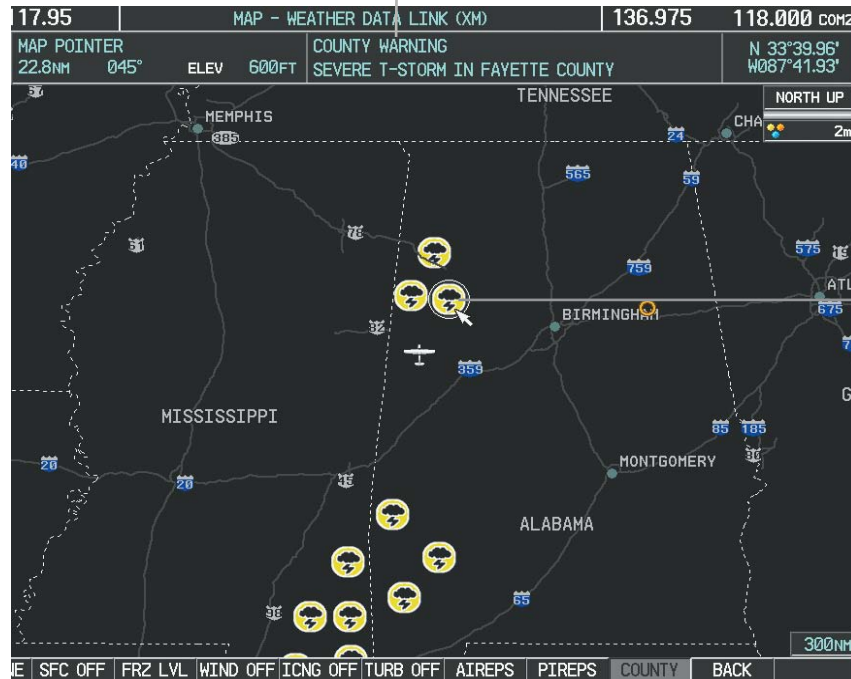

Additional Information on Thunderstorm Warning Selected with Map Pointer

Severe Thunderstorm Warning Selected

Figure 6-38 County Severe Thunderstorm Warning

Displaying County Warning information:

- 1) Select the Weather Data Link (XM) Page.
- 2) Press the **MORE WX** Softkey.
- 3) Press the **COUNTY** Softkey.

To display the County Warnings legend (Figure 6-39), press the **LEGEND** Softkey when County Warnings are selected to be displayed.

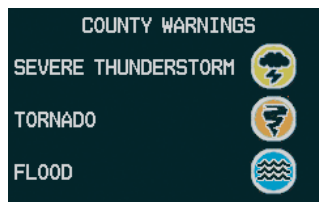

Figure 6-39 County Warnings Legend

CYCLONE

The Cyclone weather product shows the current location of cyclones (hurricanes), tropical storms, and their projected tracks.



Figure 6-40 Cyclone Data Selected for Display

Displaying cyclone (hurricane) track information:

- 1) Select the Weather Data Link (XM) Page.
- 2) Press the **MORE WX** Softkey.
- 3) Press the **CYCLONE** Softkey.

To display the Cyclone legend (Figure 6-41), press the **LEGEND** Softkey when Cyclones are selected to be displayed.

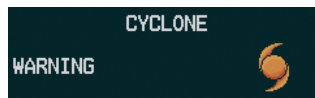

Figure 6-41 Cyclone Legend

ICING (CIP & SLD)



NOTE: Icing data cannot be displayed at the same time as NEXRAD

Current Icing Product (CIP) data (Figure 6-42) shows a graphical view of the current icing environment. Icing severity is displayed in four categories: light, moderate, severe, and extreme (not specific to aircraft type). The CIP product is not a forecast, but a presentation of the current conditions at the time of the analysis.

Supercooled Large Droplet (SLD) icing conditions are characterized by the presence of relatively large, super cooled water droplets indicative of freezing drizzle and freezing rain aloft. SLD threat areas are depicted as magenta dots over the CIP colors.

Displaying Icing data:

- 1) Select the Weather Data Link (XM) Page.
- 2) Press the **MORE WX** Softkey.
- 3) Press the **ICNG** Softkey.
- 4) Select the desired altitude level: 1,000 feet up to 30,000 feet. Press the **NEXT** or **PREV** Softkey to cycle through the altitude softkeys. The **ICNG** Softkey label changes to reflect the altitude selected.

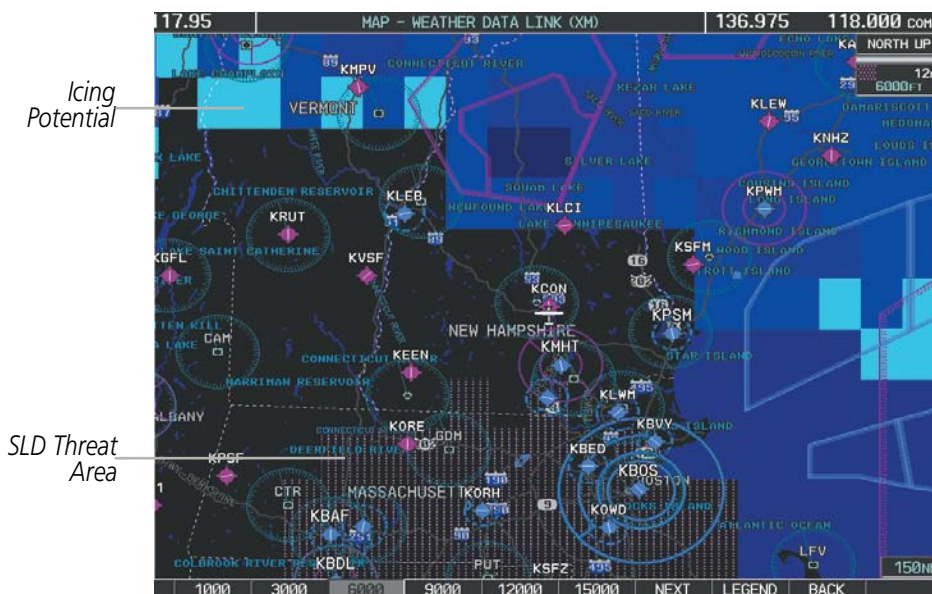

Figure 6-42 Icing Data at 6,000 Feet

To display the Icing Potential legend (Figure 6-43), press the **LEGEND** Softkey when Icing is selected for display.

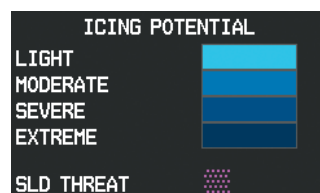

Figure 6-43 Icing Potential Legend

TURBULENCE



NOTE: Turbulence data cannot be displayed with NEXRAD data.

Turbulence data (Figure 6-44) identifies the potential for erratic movement of high-altitude air mass associated winds. Turbulence is classified as light, moderate, severe or extreme, at altitudes between 21,000 and 45,000 feet. Turbulence data is intended to supplement AIRMETs and SIGMETs.

Displaying Turbulence data:

- 1) Select the Weather Data Link (XM) Page.
- 2) Press the **MORE WX** Softkey.
- 3) Press the **TURB** Softkey.
- 4) Select the desired altitude level: 21,000 feet up to 45,000 feet. Press the **NEXT** or **PREV** Softkey to cycle through the altitude softkeys. The **TURB** Softkey label changes to reflect the altitude selected.



Figure 6-44 Turbulence Data at 21,000 Feet

To display the Turbulence legend (Figure 6-45), press the **LEGEND** Softkey when Turbulence is selected for display.

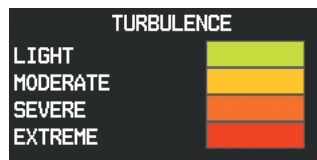

Figure 6-45 Turbulence Legend

PIREPS AND AIREPS

Pilot Weather Reports (PIREPs) (Figure 6-46) provide timely weather information for a particular route of flight. When significant weather conditions are reported or forecast, Air Traffic Control (ATC) facilities are required to solicit PIREPs. A PIREP may contain adverse weather conditions, such as low in-flight visibility, icing conditions, wind shear, and turbulence. PIREPs are issued as either Routine (UA) or Urgent (UUA).

Another type of PIREP is an Air Report (AIREP). AIREPs are used almost exclusively by commercial airlines.

Instructions for
Viewing PIREP
and AIREP Text

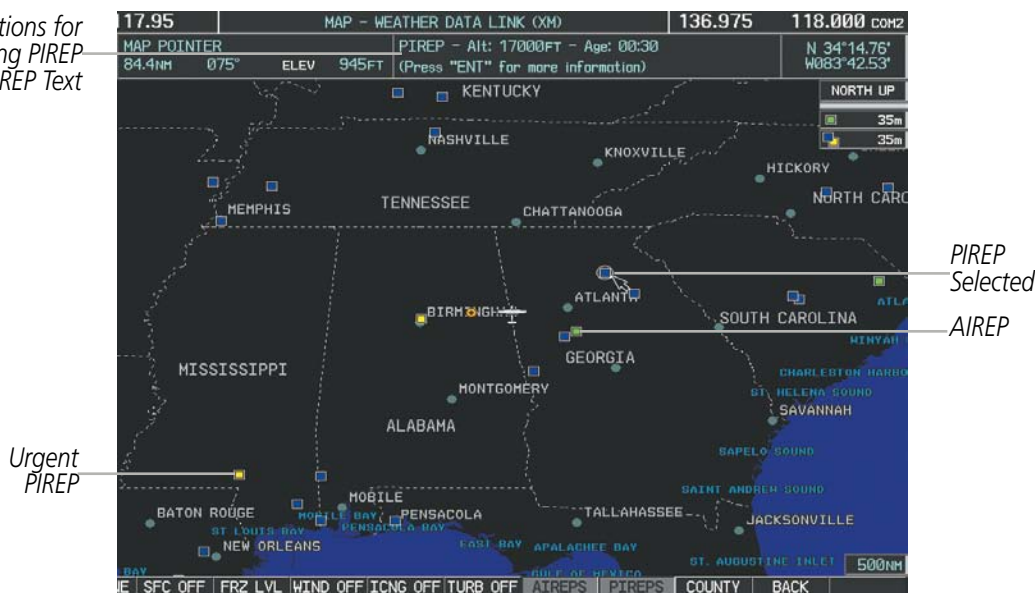

Figure 6-46 AIREPs and PIREPs on the Weather Data Link Page

Displaying PIREP and AIREP text:

- 1) Select the Weather Data Link (XM) Page.
- 2) Press the **MORE WX** Softkey.
- 3) Press the **AIREPS** or **PIREPS** Softkey.
- 4) Press the **RANGE** Knob and pan to the desired weather report. A gray circle will appear around the weather report when it is selected.
- 5) Press the **ENT** Key. The Weather Information Page is shown with PIREP or AIREP text. The data is first displayed in a decoded fashion, then as raw text.
- 6) Use the **FMS** Knob or the **ENT** Key to scroll through the PIREP or AIREP text.
- 7) Press the **FMS** Knob or the **CLR** Key to return to the Weather Data Link (XM) Page.

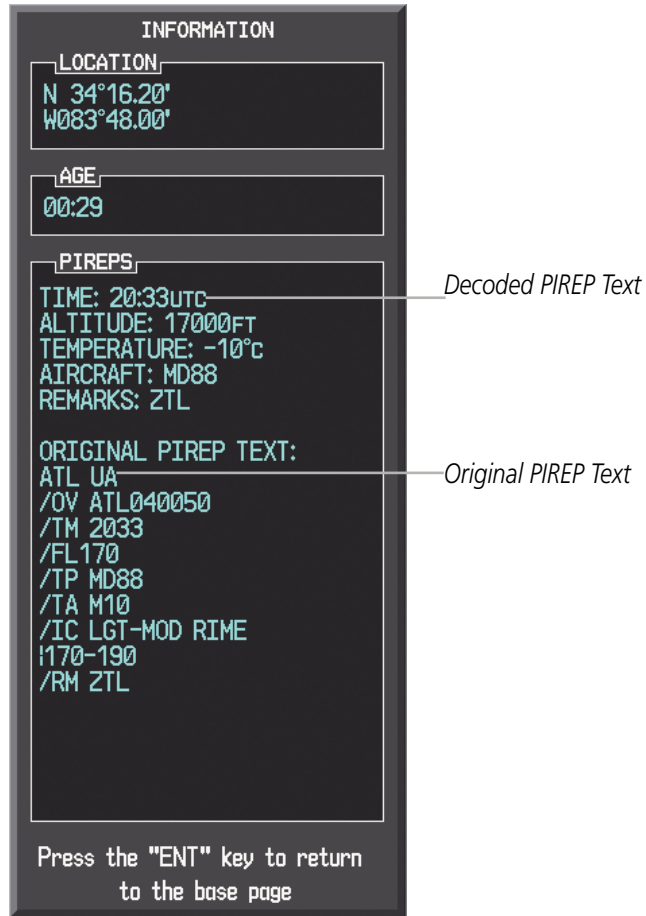

Figure 6-47 PIREP Text on the Weather Data Link (XM) Page

To display the PIREP or AIREP legend (Figure 6-48), press the **LEGEND** Softkey when PIREPs or AIREPs are selected for display.

The PIREP color is determined by the type (routine or urgent).



Figure 6-48 AIREPs & PIREPs Legend

TFRS

The Federal Aviation Administration (FAA) issues Temporary Flight Restrictions (TFRs) to designate areas where flight is restricted. TFRs are issued to restrict flight for a variety of reasons including national security, law enforcement, firefighting, natural disasters, airshows, and large sporting events. TFRs may be issued at any time, and TFR data displayed on the G1000 is only intended to supplement official TFR information obtained from official sources including Flight Service Stations (FSS), and air traffic control.

The age of TFR data is not shown; however, if TFR data is not available or has expired, the system displays 'TFR N/A' in the upper-left corner of maps on which TFRs can be displayed.

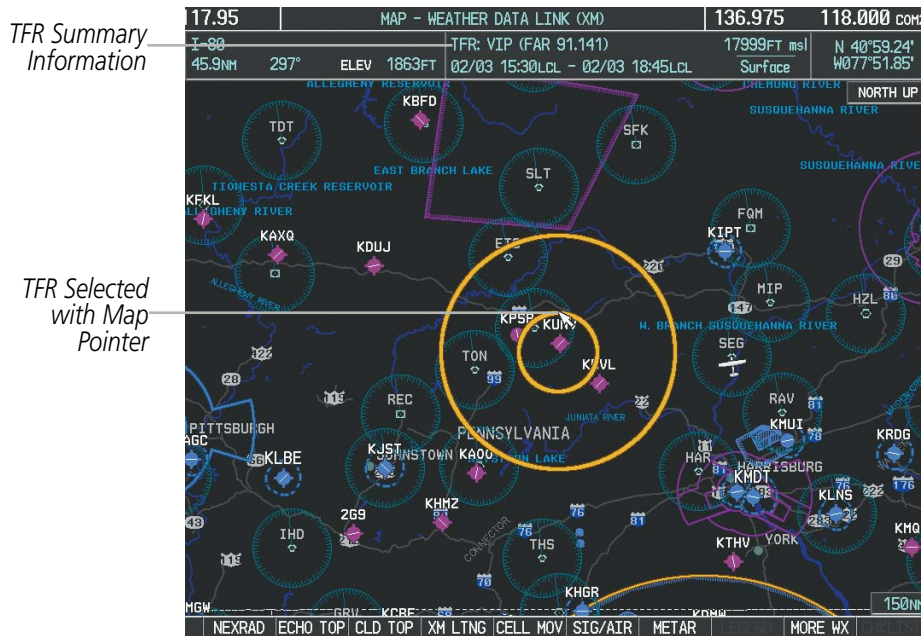

Figure 6-49 TFR Data on the Weather Data Link (XM) Page

Displaying TFR Data:

- 1) Select the Weather Data Link (XM) Page or Navigation Map Page.
- 2) Press the **RANGE** Knob and pan the map pointer over a TFR to highlight it. The system displays TFR summary information above the map.
- 3) Press the **ENT** Key. The system displays a pop-up menu.
- 4) If necessary, turn the **FMS** Knob to select 'Review Airspaces' and press the **ENT** Key. The system displays the TFR Information window.
- 5) Press the **FMS** Knob or the **CLR** Key to remove the TFR Information window.

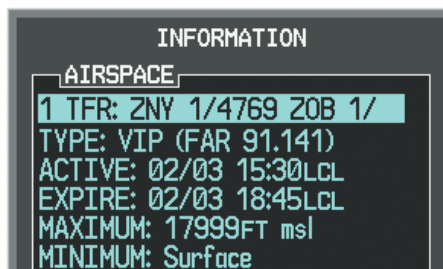

Figure 6-50 Full Text for Selected TFR

The setup menus for the Navigation Map Page control the map range settings above which TFR data is decluttered from the display. If a map range larger than the TFR product map range setting is selected, the TFR product data is removed from the map.

Maps other than the Navigation Map Page use settings based on those selected for the Navigation Map Page.

Setting up and customizing TFR data for maps on which TFR data can be displayed:

- 1) Select the Navigation Map Page.
- 2) Press the **MENU** Key.
- 3) With Map Setup highlighted, press the **ENT** Key (Figure 6-51).
- 4) Turn the small **FMS** Knob to select the Aviation Group and press the **ENT** Key (Figure 6-52).
- 5) Turn the large **FMS** Knob to scroll to the TFR product range setting (Figure 6-53).
- 6) Turn the small **FMS** Knob to scroll through options (Off, range settings).
- 7) Press the **ENT** Key to select an option.
- 8) Press the **FMS** Knob or **CLR** Key to return to the Navigation Map Page with the changed settings.

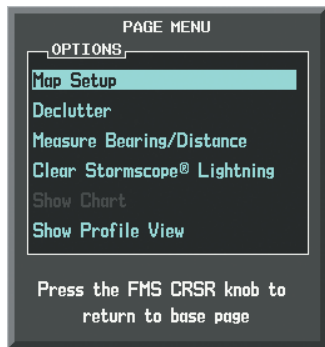

Figure 6-51 Navigation Map Page Menu



Figure 6-52 Navigation Map Page Setup Menu

MAP SETUP		
GROUP		
Aviation		
	TEXT	RNG
ACTIVE FPL		2000NM
ACTIVE FPL WPT	Med	2000NM
LARGE APT	Lrg	200NM
MEDIUM APT	Med	150NM
SMALL APT	Med	50NM
SAFETAXI		3NM
RWY EXTENSION		Off
INT WAYPOINT	Med	15NM
NDB WAYPOINT	Med	15NM
VOR WAYPOINT	Med	150NM
CLASS B/TMA		200NM
CLASS C/TCA		200NM
CLASS D		150NM
RESTRICTED		200NM
MOA (MILITARY)		200NM
OTHER/ADIZ		200NM
TFR		Off

Figure 6-53 Navigation Map Page Setup Menu, Aviation Group

REGISTERING THE SYSTEM FOR GARMIN FLIGHT DATA SERVICES

When an account is established, Garmin Flight Data services provides an Access Code which must be entered on the G1000 in order to complete the registration process.

Registering the system to receive GFDS Weather:

- 1) With the aircraft outside and having a clear view of the sky, turn the large **FMS** Knob on the MFD to select the MAP page group.
- 2) Turn the small **FMS** Knob to select the MAP-WEATHER DATA LINK (GFDS or XM or FIS-B) Page. If 'XM' or 'FIS-B' is displayed in the page title, it will be necessary to change the datalink source to GFDS before continuing. Refer to 'Viewing the Weather Data Link Page' procedure to change the datalink source to GFDS prior to registration.
- 3) If the system displays the 'Garmin Flight Data Service Registration' window, proceed to step 7. Otherwise, press the **MENU** Key. The Page Menu window is now displayed as seen in Figure 6-55.



Figure 6-55 Select Register With GFDS

- 5) Turn the large **FMS** Knob to select 'Register With GFDS' in the menu list.
- 6) Press the **ENT** Key. The Garmin Flight Data Service Registration window is displayed as shown in Figure 6-56.



Figure 6-56 Enter Access Code

- 7) Enter the access code provided by Garmin Flight Data Services in the ACCESS CODE field.
- 8) Press the **ENT** Key. 'REGISTER' will now be highlighted as in Figure 6-56.
- 9) Press the **ENT** Key. The system will contact Garmin Flight Data Services. System registration is complete when 'REGISTERED' is displayed in the STATUS field.

ACCESSING GFDS WORLDWIDE WEATHER PRODUCTS

The principal map for viewing GFDS Weather data is the Weather Data Link (GFDS) Page in the Map Page Group (Figure 6-57). This is the only map display capable of showing information for all available GFDS Worldwide Weather products. No weather data is displayed until an initial GFDS Weather Data Request has been completed.

Viewing the Weather Data Link (GFDS) Page:

- 1) Turn the large **FMS** Knob to select the Map Page Group.
- 2) Turn the small **FMS** Knob to select the Weather Data Link (GFDS) Page.

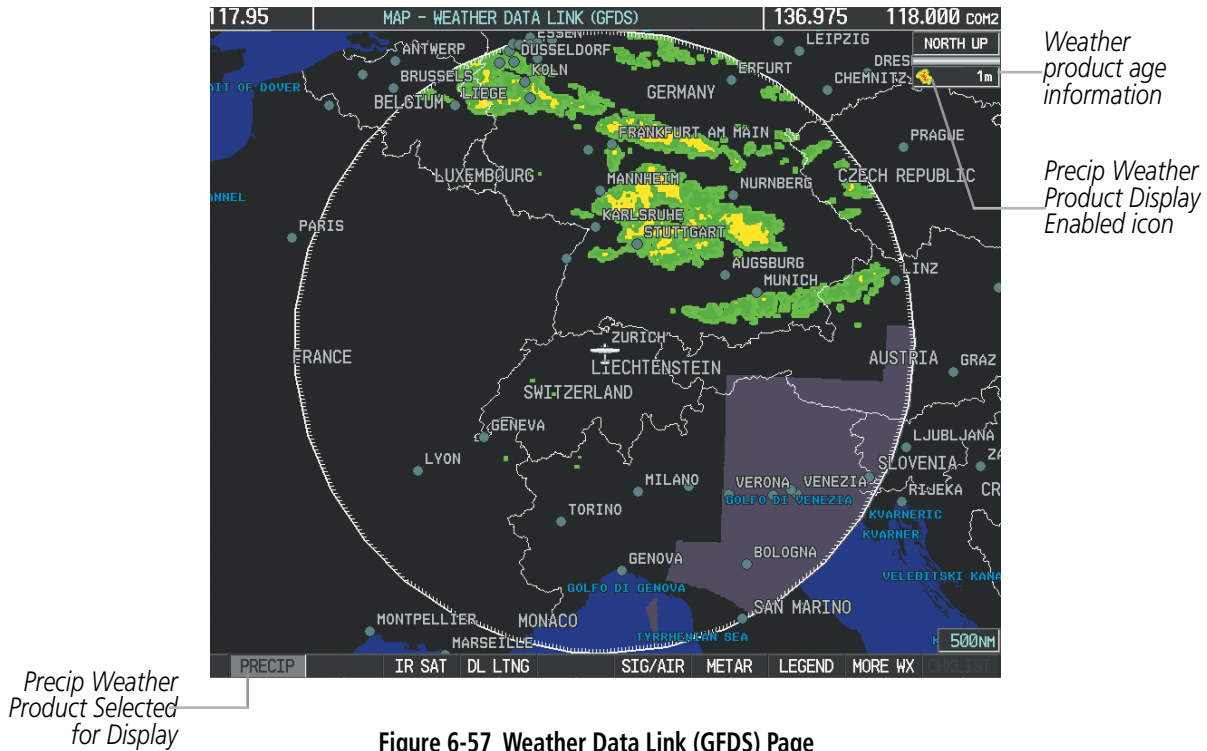

Figure 6-57 Weather Data Link (GFDS) Page (After GFDS Weather Request)







When a weather product is selected for display on the Weather Data Link (GFDS) Page, a box containing a symbol for the product and its age (in minutes) are shown in the upper right (Figure 6-57). If weather data has not been requested yet or is not available, 'N/A' is shown next to the product symbol instead of age. The age of the weather product is based on the time difference between when the data was assembled on the ground and the current GPS time. Weather products are updated continuously or refreshed at specific intervals (defined in the **Refresh Rate** column in Table 6-5).

If for any reason, a weather product is not refreshed within the defined **Expiration Time** intervals (see Table 6-5), the data is considered expired and is removed from the display. The age of the expired product is replaced by dashes. If more than half of the expiration time has elapsed, the color of the product age changes to yellow.

Table 6-5 shows the GFDS weather product symbols, the expiration time and the refresh rates. The refresh rate represents the interval at which the GFDS servers make available the most current known weather data. It does not necessarily represent the rate at which new content is received from weather sources.



NOTE: The availability of specific GFDS weather products varies by region. For GFDS product coverage information, refer to fly.garmin.com/fly-garmin/gfds-weather.

Weather Product	Symbol	Expiration Time (Minutes)	Refresh Rate (Minutes)
Radar Precipitation (PRECIP)		30	U.S.: 3* Canada: 3*† Europe: 15 Australia: 15^
Infrared Satellite (IR SAT)		60	30
Datalink Lightning (DL LTNG)		30	Continuous
SIGMETs/AIRMETs (SIG/AIR)		60	Continuous
Meteorological Aerodrome Report (METARs)		90	Continuous
Winds Aloft (WIND)		60	Continuous
Pilot Weather Report (PIREPs)		90	Continuous
Temporary Flight Restrictions (TFRs)	no product image	60	Continuous
Terminal Aerodrome Reports (TAFs)	no product image	60	Continuous

* The composite precipitation image is updated every 3 minutes, but individual radar sites may take between 3 and 10 minutes to provide new data.

† Canadian radar precipitation data provided by Environment Canada.

^ Australian radar precipitation data provided by the Australia Bureau of Meteorology

Table 6-5 GFDS Weather Product Symbols and Data Timing

Table 6-6 shows which GFDS Weather products can be displayed (indicated with a '+' symbol) on specific G1000 maps.

GFDS Weather Product	PFD Inset Map	Navigation Map Page	Weather Data Link (GFDS) Page	Weather Information Page	AUX - Trip Planning Page	Nearest Page Group	Flight Plan Pages
Precipitation (PRECIP)	+	+	+		+	+	+
Infrared Satellite (IR SAT)			+				
Datalink Lightning (LTNG)	+	+	+		+	+	+
SIGMETs/AIRMETs (SIG/AIR)			+				
METARs	+	+	+	+	+	+	+
Winds Aloft (WIND)			+				
PIREPs			+	+			
Radar Coverage	+	+	+				
TFRs	+	+	+	+	+	+	+
TAFs			+	+			

Table 6-6 GFDS Weather Product Display Maps

Softkeys control the display of weather information on most MFD pages and the PFD Inset Map (Figure 6-58 shows the weather product softkeys for the Weather Data Link (GFDS) Page). When a weather product is selected for display, the corresponding softkey label changes to gray to indicate the product display is enabled.

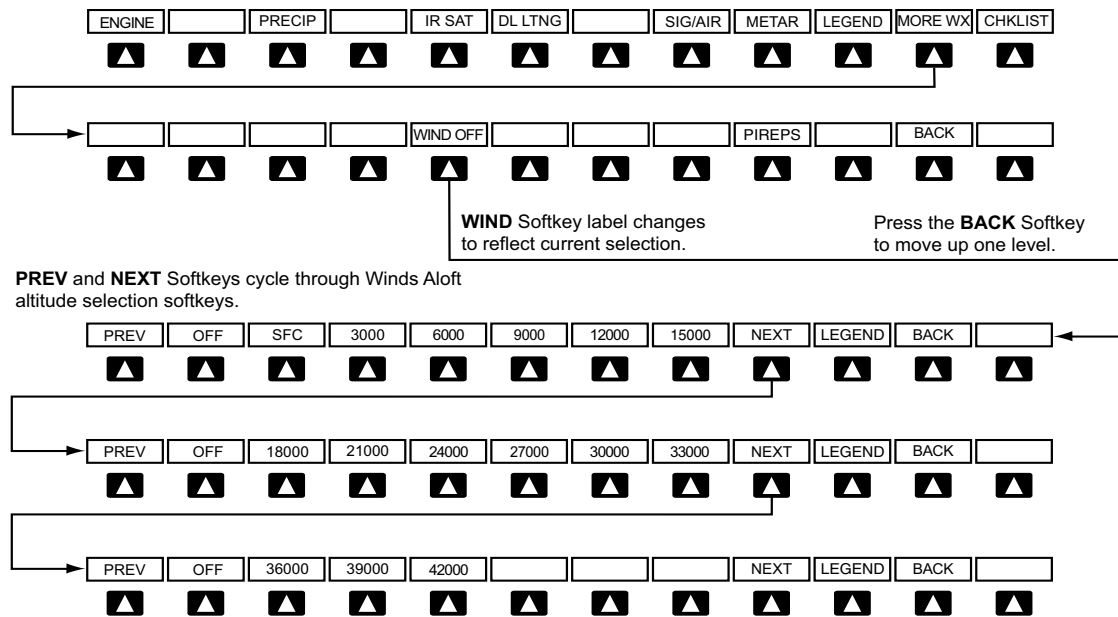

Figure 6-58 GFDS Weather Product Softkeys (MFD)

The setup menus for the Navigation Map Page and the Weather Data Link (GFDS) Page control the map range settings above which weather products data are decluttered from the display. If a map range larger than the weather product map range setting is selected, the weather product data is removed from the map. The menus also provide a means in addition to the softkeys for enabling/disabling display of weather products.

Setting up and customizing the Weather Data Link (GFDS) Page:

- 1) Select the Weather Data Link (GFDS) Page.
- 2) Press the **MENU** Key.
- 3) With 'Weather Setup' highlighted, press the **ENT** Key (Figure 6-59).
- 4) Turn the small **FMS** Knob to select 'Product Group 1' or 'Product Group 2', and press the **ENT** Key (Figure 6-60).
- 5) Turn the large **FMS** Knob or press the **ENT** Key to scroll through product selections.
- 6) Turn the small **FMS** Knob to scroll through options for each product (ON/OFF, range settings, etc.).
- 7) Press the **ENT** Key to select an option.
- 8) Press the **FMS** Knob or **CLR** Key to return to the Weather Data Link (GFDS) Page with the changed settings.



Figure 6-59 Weather Data Link (GFDS) Page Menu

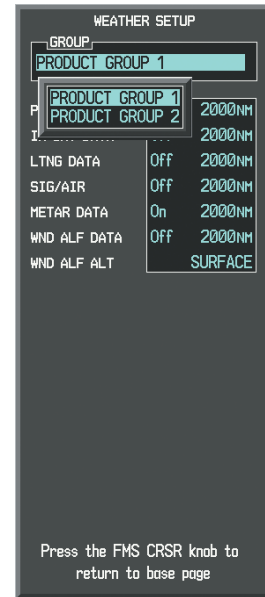

Figure 6-60 Weather Data Link (GFDS) Page Setup Menu

Restoring default Weather Data Link (GFDS) Page settings:

- 1) Select the Weather Data Link (GFDS) Page.
- 2) Press the **MENU** Key.
- 3) With 'Weather Setup' highlighted, press the **ENT** Key.
- 4) Press the **MENU** Key.
- 5) Highlight the desired default(s) to restore (all or for selection) and press **ENT** Key.

The system supports three datalink weather installation options. Only one set of datalink weather products (GFDS, XM WX, or FIS-B) can be displayed at a time.

Selecting a datalink weather source (GFDS, XM WX, or FIS-B)

- 1) Turn the large **FMS** Knob on the MFD to select the MAP page group.
- 2) Turn the small **FMS** Knob to select the Weather Data Link Page. The currently selected weather datalink provider appears in the page title (GFDS, XM, or FIS-B). To select a different weather source, proceed to the next step.
- 3) Press the **MENU** Key.
- 4) Turn the large **FMS** Knob to select 'Display GFDS Weather' or 'Display XM Weather' or 'Display FIS-B Weather' (choice dependent on current weather source) and press the **ENT** Key.

If multiple datalink weather services are installed, customizing the display settings for the corresponding weather products shown in Table 6-7 will result in identical settings for a comparable weather product from another service provider.

XM WX Product	GFDS Worldwide Weather Product	FIS-B Weather Product
Next-generation Radar (NEXRAD)	Precipitation (PRECIP)	Regional Radar Precipitation (PRECIP)
Cloud Top (CLD TOP)	Infrared Satellite (IR SAT)	Not applicable
XM Lightning (XM LTNG)	GFDS Lightning (DL LTNG)	Not applicable
SIGMETs/AIRMETs (SIG/AIR)	SIGMETs/AIRMETs (SIG/AIR)	Not applicable
Meteorological Aerodrome Report (METARs)	Meteorological Aerodrome Report (METARs)	Meteorological Aerodrome Report (METARs)
Winds Aloft (WIND)	Winds Aloft (WIND)	Not applicable
Pilot Weather Report (PIREPs)	Pilot Weather Report (PIREPs)	Not applicable

Table 6-7 Corresponding Weather Datalink Product Settings

Maps besides the Weather Data Link (GFDS) Page use settings based on those selected for the Navigation Map Page.

Setting up and customizing weather data for the Navigation Map Page:

- 1) Select the Navigation Map Page.
- 2) Press the **MENU** Key.
- 3) With 'Map Setup' highlighted, press the **ENT** Key (Figure 6-61).
- 4) Turn the small **FMS** Knob to select the 'Weather' Group and press the **ENT** Key (Figure 6-62).
- 5) Turn the large **FMS** Knob or press the **ENT** Key to scroll through product selections (Figure 6-63).
- 6) Turn the small **FMS** Knob to scroll through options for each product (ON/OFF, range settings).
- 7) Press the **ENT** Key to select an option.
- 8) Press the **FMS** Knob or **CLR** Key to return to the Navigation Map Page with the changed settings.



Figure 6-61 Navigation Map Page Menu

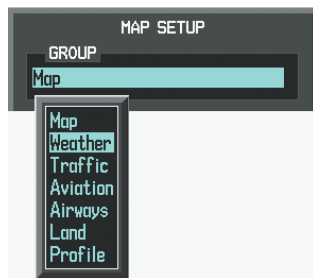

Figure 6-62 Navigation Map Page Setup Menu

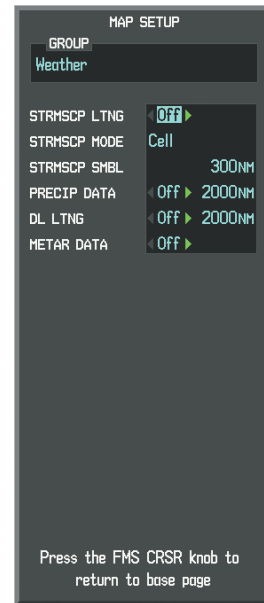

Figure 6-63 Navigation Map Page Setup Menu, Weather Group

Each active weather product has an associated legend which can be displayed on the Weather Data Link (GFDS) Page. If no weather product softkeys are selected, the **LEGEND** Softkey will be unavailable.

Viewing legends for displayed weather products

- 1) Select the Weather Data Link (GFDS) Page.
- 2) Press the **LEGEND** Softkey to display the legends for the displayed weather products.
 - Or:
 - a) Press the **MENU** Key.
 - b) Select 'Weather Legend' and press the **ENT** Key.
- 3) Turn the **FMS** Knob to scroll through the legends if more are available than fit in the window.
- 4) To remove the Legend Window, select the **LEGEND** Softkey, the **ENT** or the **CLR** Key, or press the **FMS** Knob.

Additional information about the following can be displayed by panning over the display on the map:

- Infrared Satellite (IR SAT)
- SIGMETs
- AIRMETs
- METARs
- TFRs
- PIREPs

The map panning feature is enabled by pressing the **RANGE** Knob. The map range is adjusted by turning the **RANGE** Knob. If the map range is adjusted while panning is enabled, the map is re-centered on the Map Pointer.

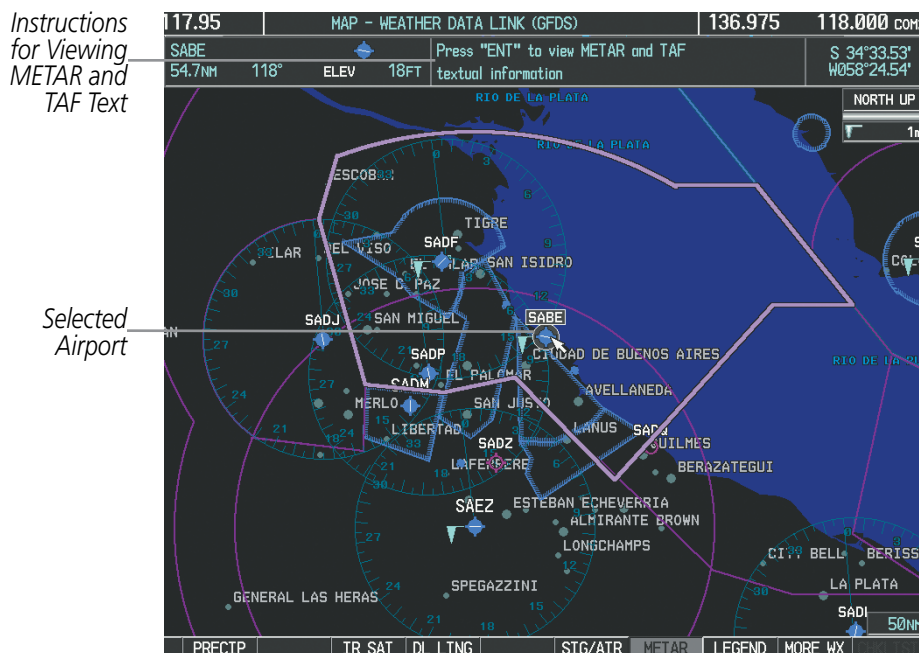

Figure 6-64 Panning on the Weather Data Link (GFDS) Page

GFDS WEATHER DATA REQUESTS

The GFDS Data Request window provides the flight crew with the options to enable or disable the requested weather coverage area(s), choose automatic weather update intervals (if desired), and the ability to send or cancel weather data requests. The status of the GFDS data request process is also displayed.

Before a GFDS data request can occur, a valid request coverage area must be defined from which all currently available GFDS weather products will be retrieved. At a minimum, either the aircraft's present position or a waypoint (as part of a flight plan or entered directly in the 'WAYPOINT' coverage field) must be part of the request coverage area, otherwise the request status window will indicate 'INVALID COVERAGE AREA' and the system will not allow a request to occur.

It is not necessary for a destination (based on an active flight plan), a flight plan, or waypoint to be specified prior to enabling these coverage areas; however no weather data will be retrieved for these option(s) until a flight plan or waypoint is provided, respectively.

Requesting GFDS weather data manually:

- 1) Select the Weather Data Link (GFDS) Page.
- 2) Press the **MENU** Key.
- 3) With 'GFDS Data Request' highlighted, press the **ENT** Key (Figure 6-65).
- 4) Turn the large **FMS** Knob to highlight the desired coverage option(s) and press the **ENT** Key to check or uncheck one or more of the following coverage selections (Figures 6-66, 6-67):
 - PRESENT POSITION – Requests data based on current location.
 - DESTINATION – Requests data based on the active flight plan destination (Direct-To destinations excluded). See the Flight Management section for more information about entering and activating flight plans.

- FPL – Requests data along an active flight plan, if one exists. Turn the small **FMS** Knob to select the desired flight plan look-ahead distance option (or choose 'REMAINING FPL' to request the remainder of the flight plan), then press the **ENT** Key.
 - WAYPOINT – Requests data based on a waypoint (which may be off-route). Turn the large and small **FMS** Knobs to enter a waypoint, then press the **ENT** Key.
- 5) Turn the large **FMS** Knob highlight to the 'DIAMETER / RTE WIDTH' (diameter/route width) distance field and turn the small **FMS** Knob to select the desired diameter and route width of the request, then press the **ENT** Key.
 - 6) Turn the large **FMS** Knob until the 'SEND REQ' button is highlighted. Press the **ENT** Key to initiate the request immediately or press the **FMS** Knob to return to the Weather Data Link (GFDS) Page without requesting weather data.



Figure 6-65 Weather Data Link (GFDS) Page Menu

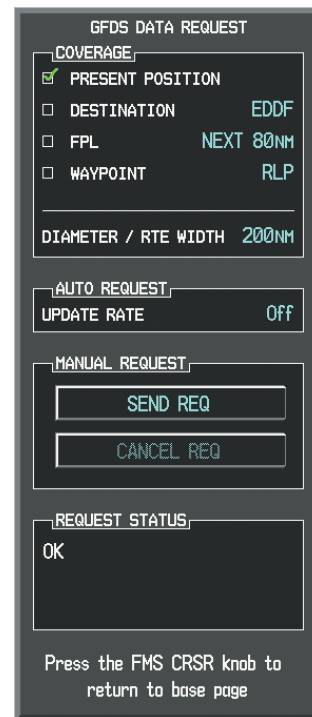

Figure 6-66 GFDS Data Request Window

- SYSTEM OVERVIEW
- FLIGHT INSTRUMENTS
- EIS
- AUDIO PANEL & CNS
- FLIGHT MANAGEMENT
- HAZARD AVOIDANCE
- AFCS
- ADDITIONAL FEATURES
- APPENDICES
- INDEX

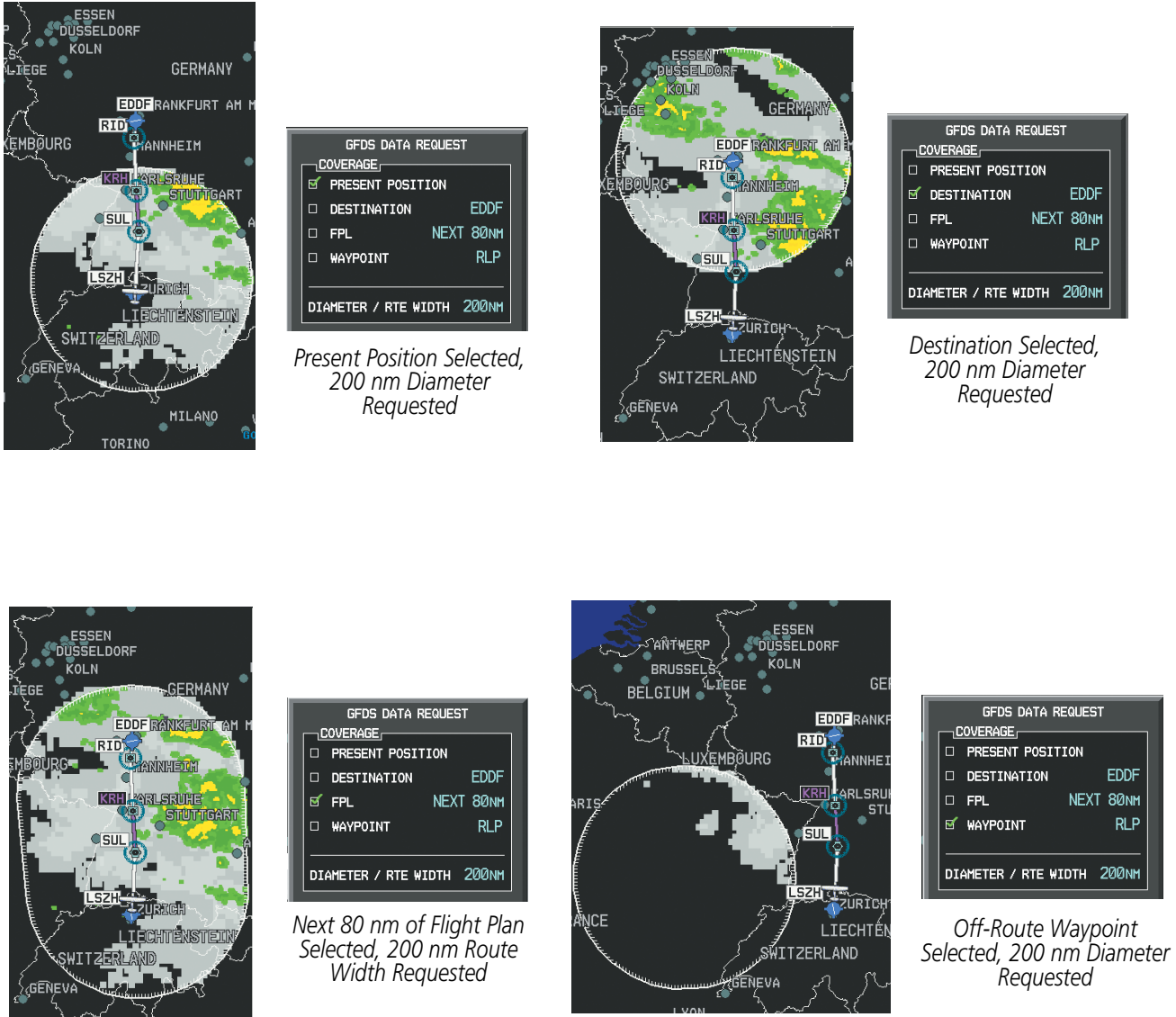

Figure 6-67 GFDS Weather Data Request Results with Precipitation and Infrared Satellite Displayed

During a GFDS Data Request, the Request Status box initially displays “Contacting GFDS...”. Once a connection is established, the Request Status Box displays “Receiving Wx Data... Time Remaining:” with an estimated data transfer time (either minutes or seconds). If desired, the GFDS Data Request window may be closed while the data request is processing by pressing the **FMS** Knob; the data request will continue to process in the background. GFDS Data Requests typically take between 1 to 4 minutes to complete depending on the size of the selected weather coverage area and Iridium signal strength.

The system retrieves all available Worldwide Weather products within the selected coverage area during an initial GFDS Data Request, regardless of which products (if any) are currently enabled for display. On subsequent requests, previously retrieved textual data (such as METARs and TAFs) is retained if it has not expired, while new textual weather data matching the current coverage area and all graphical weather data is downloaded during every data request.

At the completion of a successful weather data request, the request status window (if still open) will indicate 'OK'.

Canceling a GFDS Weather Data Request in Progress:

- 1) Select the Weather Data Link (GFDS) Page.
- 2) Press the **MENU** Key.
- 3) With 'GFDS Data Request' highlighted, press the **ENT** Key.
- 4) Turn the large **FMS** Knob to select 'CANCEL REQ' and press the **ENT** Key. The request status box indicates 'Request Cancelled'.
- 5) Press the **FMS** Knob to return to the Weather Data Link (GFDS) Page.

The pilot can schedule GFDS data requests to recur automatically. Auto requests remain enabled until the pilot disables them, or the system power is cycled. The Request Status window will indicate a countdown timer until the next automatic data request occurs.



NOTE: *If automatic GFDS data requests were enabled prior to the system entering Reversionary Mode, the automatic weather data requests will continue in Reversionary Mode, however the GFDS Data Request window and its associated options will not be available.*

Enabling/disabling automatic GFDS Data Requests:

- 1) Select the Weather Data Link (GFDS) Page.
- 2) Press the **MENU** Key.
- 3) With 'GFDS Weather Request' highlighted, press the **ENT** Key.
- 4) Choose the desired weather coverage options.
- 5) Turn the large **FMS** Knob to select the 'UPDATE RATE' setting. Then turn the small **FMS** Knob to highlight the desired automatic update frequency (OFF, 5 Min, 10 Min, 15 Min, 20 Min, 25 Min, 30 Min, 45 Min, or 60 Min), then press the **ENT** Key.
- 6) The 'SEND REQ' button is highlighted and a countdown timer is displayed in the 'REQUEST STATUS' based on the currently selected update rate. Press the **ENT** Key to immediately send an immediate GFDS Data Request.

Or:

Press the **FMS** Knob to return to the Weather Data Link (GFDS) Page.

WORLDWIDE WEATHER PRODUCTS

PRECIPITATION

Precipitation (PRECIP) data is not real-time. The lapsed time between collection, processing, and dissemination of radar images can be significant and may not reflect the current radar synopsis. Due to the inherent delays and the relative age of the data, it should be used for long-range planning purposes only.

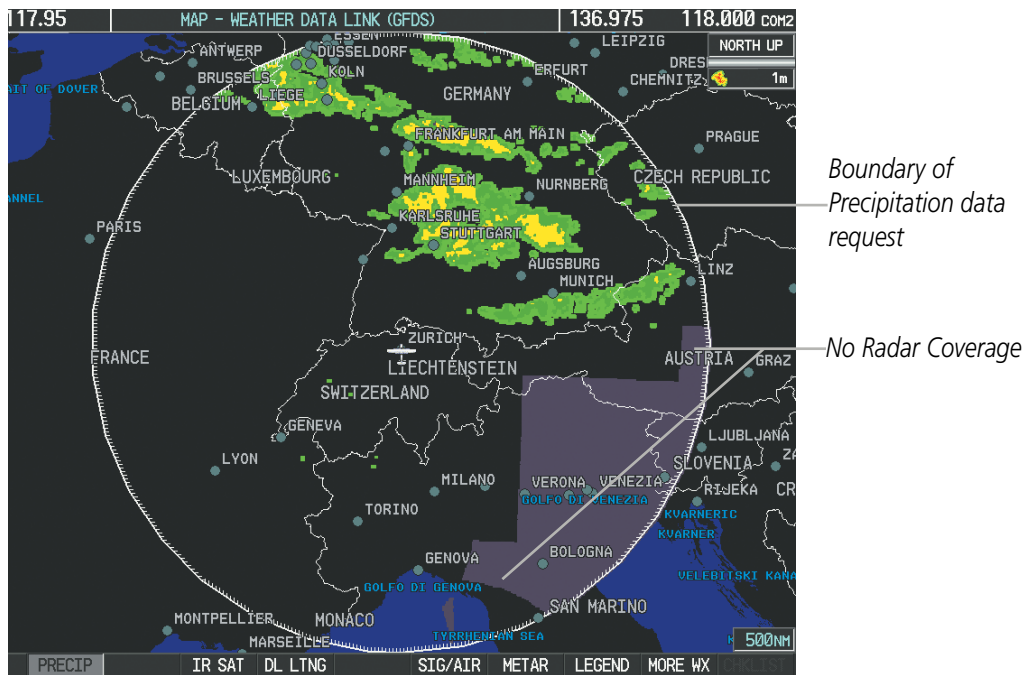

Figure 6-68 Precipitation Data on the Weather Data Link (GFDS) Page

Precipitation data can be displayed on the following maps:

- PFD Inset Map
- Navigation Map Page
- Weather Data Link (GFDS) Page
- Airport Information Page
- Trip Planning Page
- Nearest Pages
- Flight Plan Pages
- AUX - Video Page

Displaying Precipitation weather information:

- 1) Select the **MAP** Softkey (for the PFD Inset Map, select the **INSET** Softkey). This step is not necessary on the Weather Data Link (GFDS) Page.
- 2) Press the **PRECIP** Softkey.

Radar data shown represents lowest level, base reflectivity, of radar returns. The display of the information is color-coded to indicate the weather severity level. All weather product legends can be viewed on the Weather Data Link (GFDS) Page. For the Precipitation legend (Figure 6-69), press the **LEGEND** Softkey when Precipitation is selected for display.

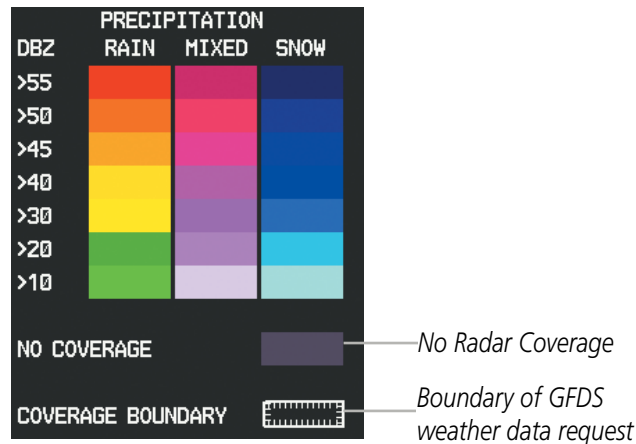

Figure 6-69 Precipitation Data Legend

The display of radar coverage is enabled when Precipitation is selected for display. Areas where precipitation radar coverage is not currently available or is not being collected are indicated in gray shade of purple. A white boundary line with white tick marks depicts the selected coverage area of the GFDS weather data request. This boundary encloses the precipitation data when this weather product is displayed.

REFLECTIVITY

Reflectivity is the amount of transmitted power returned to the radar receiver. Colors on the Precipitation display directly correlate to the level of detected reflectivity. Reflectivity as it relates to hazardous weather can be very complex.

The role of radar is essentially to detect moisture in the atmosphere. Simply put, certain types of weather reflect radar better than others. The intensity of a radar reflection is not necessarily an indication of the weather hazard level. For instance, wet hail returns a strong radar reflection, while dry hail does not. Both wet and dry hail can be extremely hazardous.

The different radar echo intensities are measured in decibels (dB) relative to reflectivity (Z). Weather radars measure the reflectivity ratio, or the energy reflected *back to* the radar receiver (designated by the letter Z). The value of Z increases as the returned signal strength increases.

PRECIPITATION LIMITATIONS

Radar images may have certain limitations:

- Radar base reflectivity does not provide sufficient information to determine cloud layers or precipitation characteristics (wet hail vs. rain). For example, it is not possible to distinguish between wet snow, wet hail, and rain.
- Radar base reflectivity is sampled at the minimum antenna elevation angle. An individual radar site cannot depict high altitude storms at close ranges. It has no information about storms directly over the site.
- When zoomed in to a range of 30 nm, each square block on the display represents an area of four square kilometers.

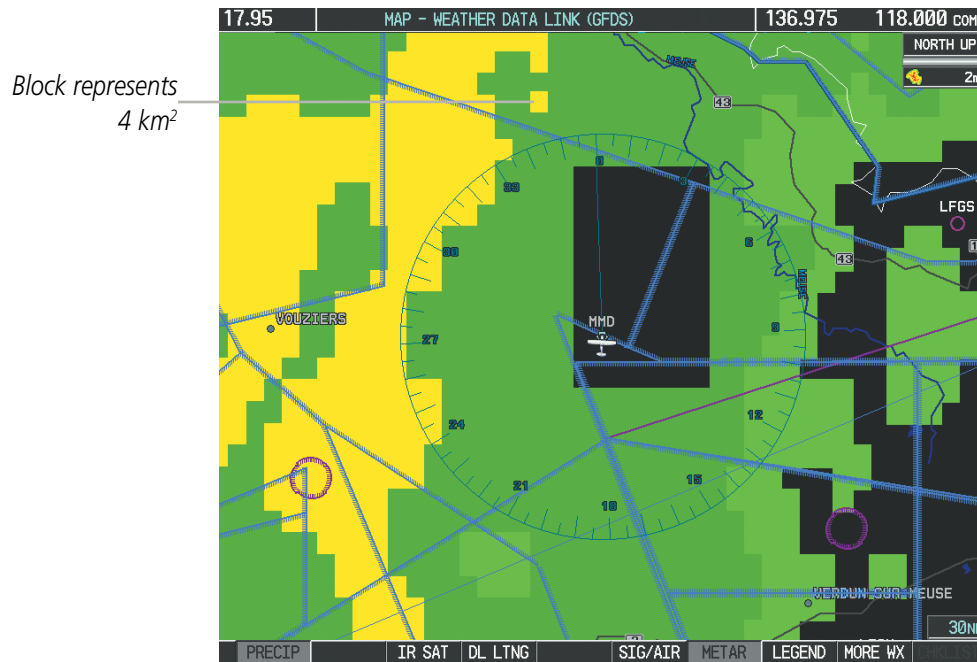

Figure 6-70 Precipitation Data - Zoomed

The following may cause abnormalities in displayed radar images:

- Ground clutter
- Strokes and spurious radar data
- Sun strokes (when the radar antenna points directly at the sun)
- Interference from buildings or mountains, which may cause shadows
- Metallic dust from military aircraft, which can cause alterations in radar scans

INFRARED SATELLITE

Infrared Satellite (IR SAT) data (Figure 6-71) depicts cloud top temperatures from satellite imagery. Brighter cloud top colors indicate cooler temperatures occurring at higher altitudes.

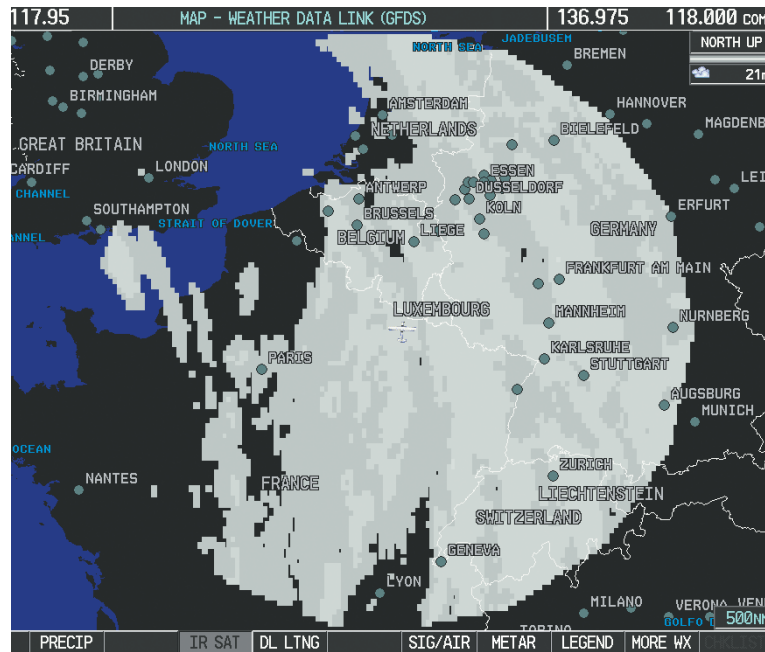

Figure 6-71 Infrared Satellite Data on the Weather Data Link (GFDS) Page

Displaying Cloud Tops information:

- 1) Select the Weather Data Link (GFDS) Page.
- 2) Press the **IR SAT** Softkey.

To display the Infrared Satellite legend (Figure 6-72), select the **LEGEND** Softkey when Infrared Satellite data is selected for display.



Figure 6-72 Infrared Satellite Legend

DATALINK LIGHTNING

Datalink Lightning (DL LTNG) data (Figure 6-73) shows the approximate location of cloud-to-ground lightning strikes. A strike icon represents a strike that has occurred within a two-kilometer region. Neither cloud-to-cloud nor the exact location of the lightning strike is displayed.

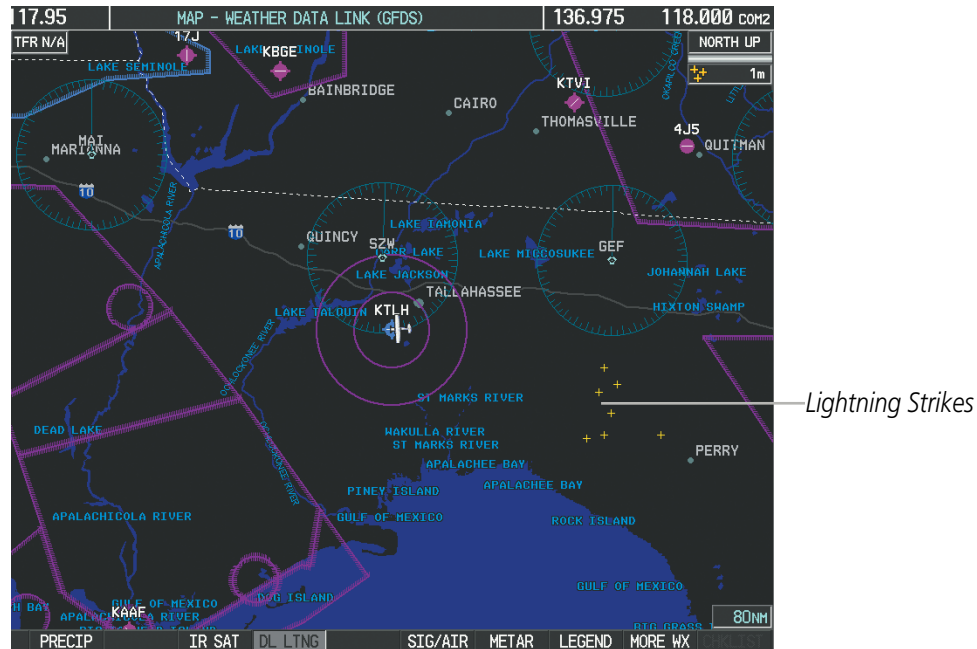

Figure 6-73 Datalink Lightning

Datalink Lightning data displayed on the following maps:

- PFD Inset Map
- Navigation Map Page
- Weather Data Link Page
- AUX - Video Page
- Trip Planning Page
- Nearest Pages
- Flight Plan Pages

Displaying Datalink Lightning information:

- 1) Press the **MAP** Softkey (for the PFD Inset Map, select the **INSET** Softkey). This step is not necessary on the Weather Data Link (GFDS) Page.
- 2) Press the **DL LTNG** Softkey.

To display the Datalink Lightning legend on the Weather Data Link (GFDS) Page (Figure 6-74), select the **LEGEND** Softkey when Datalink Lightning is selected for display.

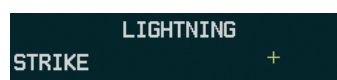

Figure 6-74 Datalink Lightning Legend

SIGMETs AND AIRMETs

SIGMETs (SIGnificant METeorological Information) and AIRMETs (AIRmen's METeorological Information) are issued for potentially hazardous weather. A Convective SIGMET is issued for hazardous convective weather such as severe or widespread thunderstorms. A localized SIGMET can be displayed when significant weather conditions are not widespread.

The entire SIGMET or AIRMET is displayed as long as any portion of it is issued within the coverage area of the GFDS data request.

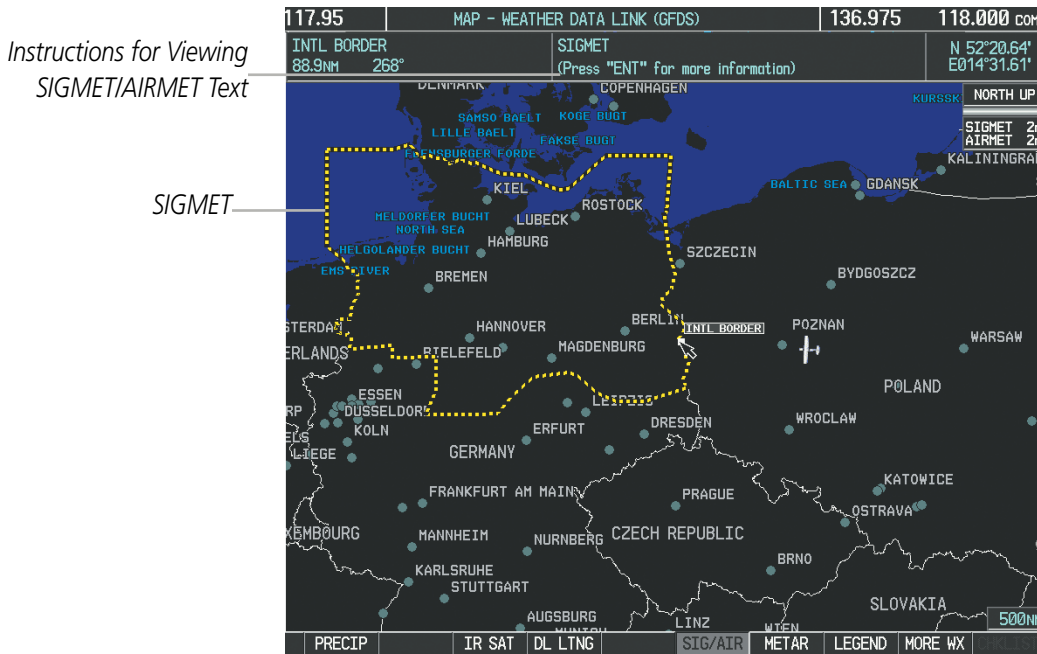

Figure 6-75 SIGMET/AIRMET Data

Displaying SIGMETs and AIRMETs:

- 1) Select the Weather Data Link (GFDS) Page.
- 2) Press the **SIG/AIR** Softkey.
- 3) To view the text of the SIGMET or AIRMET, press the **RANGE** Knob and move the Map Pointer over the icon.
- 4) Press the **ENT** key. Figure 6-76 shows sample SIGMET text.

To display the SIGMET and AIRMET legend (Figure 6-77), select the **LEGEND** Softkey when SIGMETs and AIRMETs are selected for display.



Figure 6-76 Sample SIGMET Text



Figure 6-77 SIGMET/AIRMET Legend

METARS AND TAFS



NOTE: Atmospheric pressure as reported for METARs is given in hectopascals (hPa), except for in the United States, where it is reported in inches of mercury (in Hg). Temperatures are reported in Celsius.



NOTE: METAR information is only displayed within the installed navigation database service area.

METARs (METeorological Aerodrome Reports) typically contain information about the temperature, dewpoint, wind, precipitation, cloud cover, cloud heights, visibility, and barometric pressure at an airport or observation station. They can also contain information on precipitation amounts, lightning, and other critical data. METARs reflect hourly observations; non-routine updates include the code “SPECI” in the report. METARs are shown as colored flags at airports that provide them.



Figure 6-78 METAR Flags on the Weather Data Link Page

TAFs (Terminal Aerodrome Forecasts) are weather predictions for specific airports within a 24- hour period, and may span up to 36 hours. TAFs typically include forecast wind, visibility, weather phenomena, and sky conditions using METAR codes.

METAR and TAF text are displayed on the Weather Information Page. METAR data is displayed first in a decoded fashion, then as raw text. TAF information is displayed only in its raw form when it is available

Displaying METAR and TAF text:

- 1) On the Weather Data Link (XM) Page, press the **METAR** Softkey.
- 2) Press the **RANGE** Knob and pan to the desired airport.
- 3) Press the **ENT** Key. The Weather Information Page is shown with METAR and TAF text.
- 4) Use the **FMS** Knob or the **ENT** Key to scroll through the METAR and TAF text. METAR text must be completely scrolled through before scrolling through the TAF text.

- 5) Press the **FMS** Knob or the **CLR** Key to return to the Weather Data Link (XM) Page.
 - Or:
 - 1) Select the Weather Information Page.
 - a) Turn the large **FMS** Knob to select the Waypoint Page Group.
 - b) Press the **WX** Softkey to select the Weather Information Page.
 - 2) Press the **FMS** Knob to display the cursor.
 - 3) Use the **FMS** Knob to enter the desired airport and press the **ENT** Key.
 - 4) Use the **FMS** Knob or the **ENT** Key to scroll through the METAR and TAF text. Note that the METAR text must be completely scrolled through before scrolling through the TAF text.

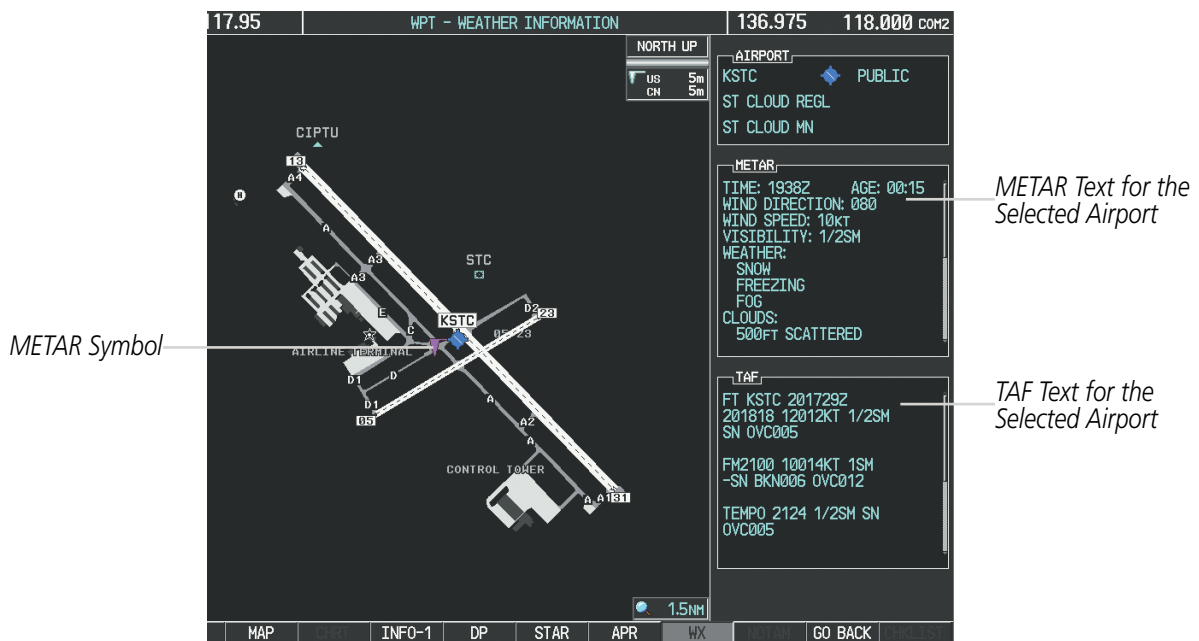

Figure 6-79 METAR and TAF Text on the Weather Information Page

Raw METAR text is also accessible while panning the map cursor over a METAR flag on any map page on which a METAR is displayed. The METAR text is shown in a box near the METAR flag.

In addition, METAR flags and their associated text are displayed on the Active Flight Plan Page on the MFD. METAR flags appear next to waypoints in the flight plan with an associated METAR. A solid light blue METAR flag indicates the METAR observations are available for a specific waypoint; a hollow light blue METAR flag indicates an off-route METAR near the waypoint is available. When off-route METAR text is displayed, the system provides additional information as to the origin, distance, and direction of the report in relation to the selected flight plan waypoint.

Displaying raw METAR text on the Active Flight Plan Page:

- 1) Select the Active Flight Plan Page on the MFD.
- 2) Press the **FMS** Knob to activate the cursor.
- 3) Turn the large **FMS** Knob to highlight the desired waypoint. The METAR text will appear in the 'SELECTED WAYPOINT WEATHER' window below.
- 4) When finished, press the **FMS** Knob to remove the cursor or press the **FPL** Key to exit the Active Flight Plan Page.

To display the METAR legend on the Weather Data Link (XM) Page (Figure 6-80), press the **LEGEND** Softkey when METARs are selected for display.

The METAR flag color is determined by the information in the METAR text. A gray METAR flag is displayed when the METAR text does not contain adequate information.



Figure 6-80 METAR Legend

WINDS ALOFT

Winds Aloft data (Figure 6-81) shows the forecasted wind speed and direction at the surface and at selected altitudes. Altitude can be displayed in 3,000-foot increments up to 42,000 feet MSL.

Displaying Winds Aloft data:

- 1) Select the Weather Data Link (GFDS) Page.
- 2) Press the **MORE WX** Softkey.
- 3) Press the **WIND** Softkey.
- 4) Select the desired altitude level: SFC (surface) up to 42,000 feet. Select the **NEXT** or **PREV** Softkey to cycle through the altitude softkeys. The **WIND** Softkey label changes to reflect the altitude selected.



Figure 6-81 Winds Aloft at 3,000 Feet

To display the Winds Aloft legend (Figure 6-82), press the **LEGEND** Softkey when Winds Aloft is selected for display.

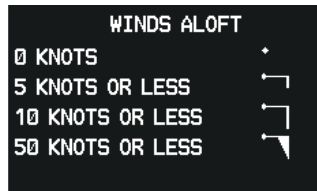

Figure 6-82 Winds Aloft Data with Legend

Headwind and tailwind components aloft are available inside the Profile View on the Navigation Map Page (Figure 6-83). The displayed components are relative to current aircraft altitude and track, but not to aircraft speed.

- SYSTEM OVERVIEW
- FLIGHT INSTRUMENTS
- EIS
- AUDIO PANEL & CNS
- FLIGHT MANAGEMENT
- HAZARD AVOIDANCE
- AFCS
- ADDITIONAL FEATURES
- APPENDICES
- INDEX



Figure 6-83 Navigation Map Page with Winds Aloft Data on Profile View

Arrows pointing to the left indicate headwind components; tailwind component arrows point to the right, as shown in Table 6-8.

Headwind Symbol	Tailwind Symbol	Headwind/Tailwind Component
None	None	Less than 5 knots
		5 knots
		10 knots
		50 knots

Table 6-8 Profile View Headwind/Tailwind Component Symbols

Showing/Hiding Profile View (containing winds aloft data)

- 1) Select the Navigation Map Page.
 - 2) Press the **MAP** Softkey.
 - 2) Press the **PROFILE** Softkey.
- Or:**
- 1) Press the **MENU** Key.

- 2) Turn the large FMS Knob to highlight 'Show Profile View' or 'Hide Profile View' (choice dependent on current state) and press the **ENT** Key.

Winds Aloft data inside the Profile View is enabled by default when the Profile View is displayed on the Navigation Map Page. This behavior can be changed on the Navigation Map Page.

Enabling/disabling winds aloft data display in Profile View:

- 1) Select the Navigation Map Page.
- 2) Press the **MENU** Key.
- 3) With Map Setup highlighted, press the **ENT** Key (Figure 6-84).
- 4) Turn the small **FMS** Knob to select the Profile Group and press the **ENT** Key (Figure 6-85).
- 5) Turn the large **FMS** Knob to select 'Profile Winds' (Figure 6-86).
- 6) Turn the small **FMS** Knob to select 'On' or 'Off'.
- 7) Press the **FMS** Knob or **CLR** Key to return to the Navigation Map Page with the changed settings.

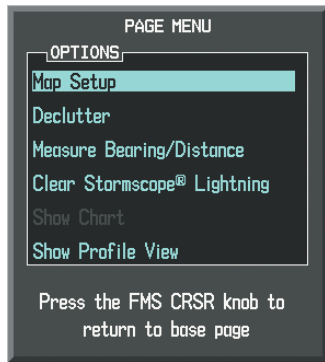

Figure 6-84 Navigation Map Page Menu



Figure 6-85 Navigation Map Page Setup Menu



Figure 6-86 Navigation Map Page Setup Menu, Weather Group

PIREPS

Pilot Weather Reports (PIREPs) describe in-flight weather encountered by pilots. A PIREP may contain unforecast adverse weather conditions, such as low in-flight visibility, icing conditions, wind shear, turbulence, and type of aircraft flown. PIREPs are issued as either Routine (UA) or Urgent (UUA).

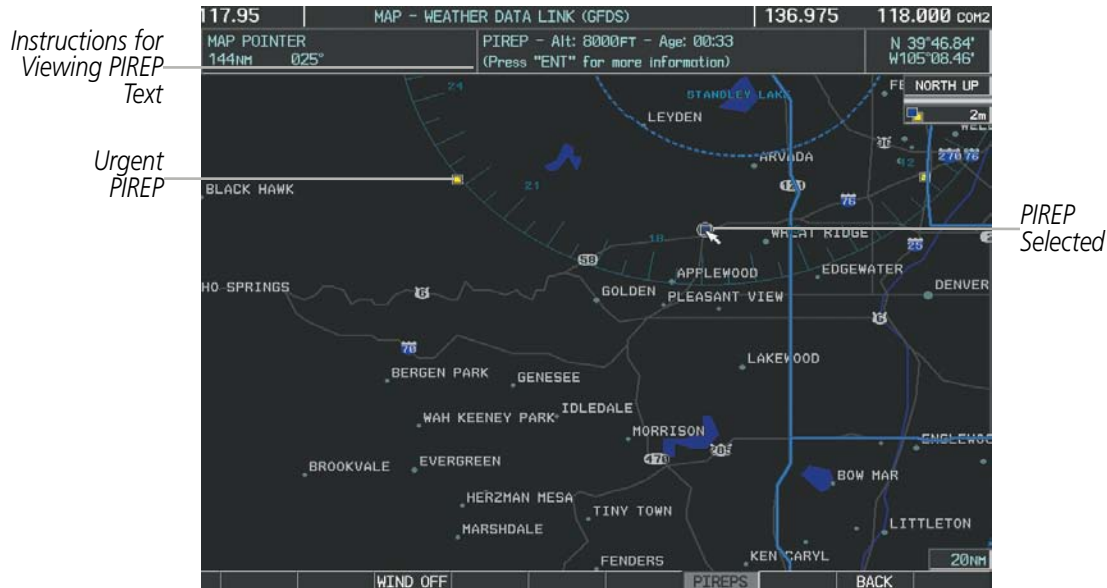

Figure 6-87 PIREPs on the Weather Data Link (GFDS) Page

Displaying PIREP text:

- 1) Select the Weather Data Link (GFDS) Page.
- 2) Press the **MORE WX** Softkey.
- 3) Press the **PIREPS** Softkey.
- 4) Press the **RANGE** Knob and pan to the desired weather report. A gray circle will appear around the weather report when it is selected.
- 5) Press the **ENT** Key. The PIREP text is first displayed in a decoded fashion, then as raw text.
- 6) Use the **FMS** Knob or the **ENT** Key to scroll through the PIREP text.
- 7) Press the **FMS** Knob or the **CLR** Key to close the PIREP text window and return to the Weather Data Link (GFDS) Page.

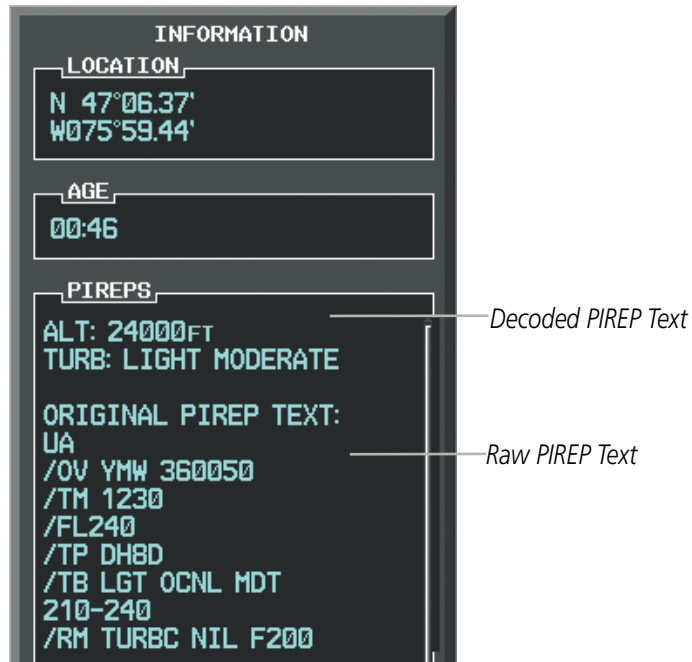

Figure 6-88 PIREP Text on the Weather Data Link (GFDS) Page

To display the PIREP legend (Figure 6-89), press the **LEGEND** Softkey when PIREPs are selected for display. The PIREP color is determined by the type (routine or urgent).



Figure 6-89 AIREPs & PIREPs Legend

TFRS



NOTE: Temporary Flight Restriction (TFR) data from GFDS is only available in the United States (not including any U.S. territories.) Refer to fly.garmin.com/fly-garmin/gfds-weather for GFDS product coverage information.

In the United States, the Federal Aviation Administration (FAA) issues Temporary Flight Restrictions (TFRs) to designate areas where flight is restricted. TFRs are issued to restrict flight for a variety of reasons including national security, law enforcement, firefighting, natural disasters, airshows, and large sporting events. TFRs may be issued at any time, and TFR data displayed on the G1000 is only intended to supplement official TFR information obtained from Flight Service Stations (FSS), and air traffic control.

The age of TFR data is not shown; however, if TFR data is not available or has expired, the system displays 'TFR N/A' in the upper-left corner of maps on which TFRs can be displayed.

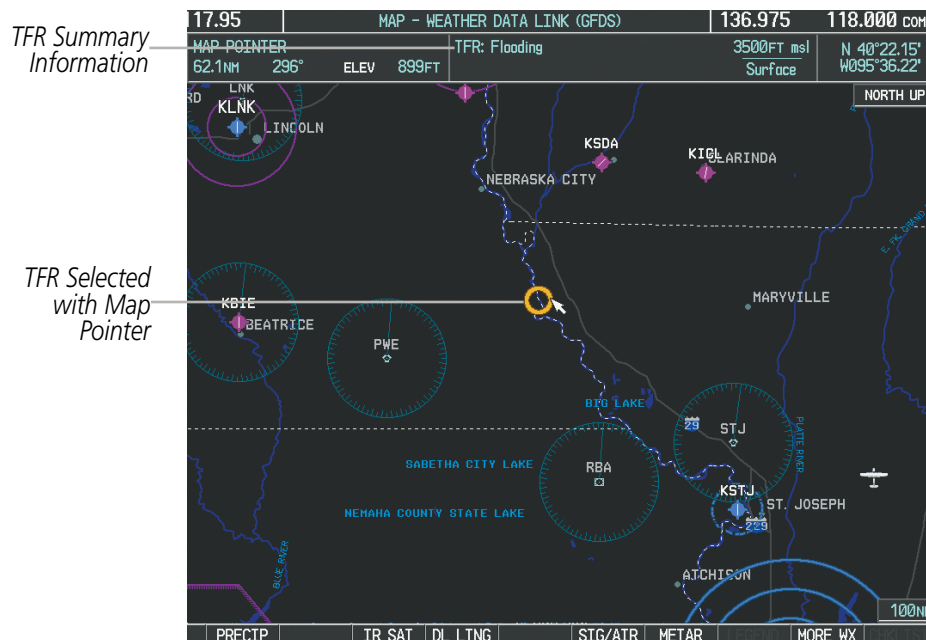

Figure 6-90 TFR Data on the Weather Data Link (XM) Page

Displaying TFR Data:

- 1) Select the Weather Data Link (GFDS) Page or Navigation Map Page.
- 2) Press the **RANGE** Knob and pan the map pointer over a TFR to highlight it. The system displays TFR summary information above the map.
- 3) Press the **ENT** Key. The system displays a pop-up menu.
- 4) If necessary, turn the **FMS** Knob to select 'Review Airspaces' and press the **ENT** Key. The system displays the TFR Information window (Figure 6-91).
- 5) Press the **FMS** Knob or the **CLR** Key to remove the TFR Information window.

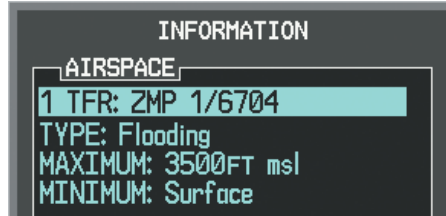

Figure 6-91 Full Text for Selected TFR

The setup menus for the Navigation Map Page control the map range settings above which TFR data is decluttered from the display. If a map range larger than the TFR product map range setting is selected, the TFR product data is removed from the map.

Maps other than the Navigation Map Page use settings based on those selected for the Navigation Map Page.

Setting up and customizing TFR data for maps on which TFR data can be displayed:

- 1) Select the Navigation Map Page.
- 2) Press the **MENU** Key.
- 3) With Map Setup highlighted, press the **ENT** Key (Figure 6-92).
- 4) Turn the small **FMS** Knob to select the Aviation Group and press the **ENT** Key (Figure 6-93).
- 5) Turn the large **FMS** Knob to scroll to the TFR product range setting (Figure 6-94).
- 6) Turn the small **FMS** Knob to scroll through options (Off, range settings).
- 7) Press the **ENT** Key to select an option.
- 8) Press the **FMS** Knob or **CLR** Key to return to the Navigation Map Page with the changed settings.



Figure 6-92 Navigation Map Page Menu



Figure 6-93 Navigation Map Page Setup Menu

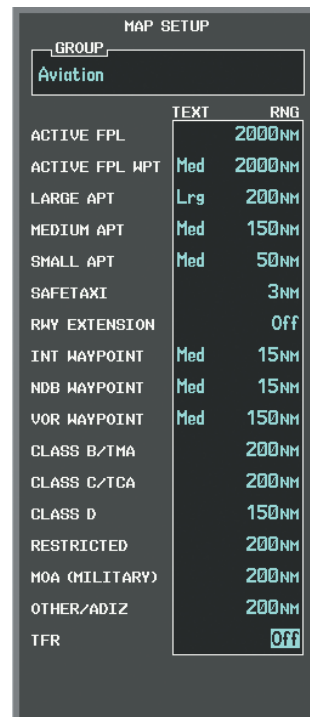

Figure 6-94 Navigation Map Page Setup Menu, Weather Group

ABNORMAL OPERATIONS

If the system cannot complete a GFDS weather data request, one or more messages will appear in the request status window.

Weather Request Status Message	Description
Auto requests inhibited Send manual request to reset.	The system has disabled automatic weather data requests due to excessive errors. Automatic weather data requests have stopped. Send a manual weather data request to resume automatic updates.
Auto update retry: ## Seconds	The system will attempt another automatic weather data request after an error occurred during the previous request. Timer counts down until the next automatic request occurs.
GFDS Comm Error [2]	A communications error has occurred with the GIA. The G1000 should be serviced.
GFDS Comm Error [4]	This occurs if multiple automatic weather data requests have recently failed, or a GIA is off-line.
GFDS Comm Error [5]	The Iridium or GFDS networks are not accessible. Check Iridium signal strength. If this error persists, the G1000 should be serviced.
GFDS Comm Error [6]	A communications error has occurred. If this error persists, the G1000 should be serviced.
GFDS Comm Error [7]	A weather data transfer has timed out. Check Iridium signal strength and re-send the data request.
GFDS Comm Error [8]	A server error has occurred or invalid data received.
GFDS Login Invalid	There is a problem with the GFDS registration. Contact Garmin Flight Data Services at 1-866-739-5687 in the United States or 913-397-8200, ext. 1135 for assistance.
GFDS Server Temporarily Inop	The GFDS weather data server is temporarily out of service, but is expected to return to service in less than 30 minutes.
GFDS Server Inop	The GFDS weather data server will be out of service for at least 30 minutes.
Invalid Coverage Area	The weather data request coverage area does not contain at least one of the following: a waypoint, a flight plan, or a flight plan destination. Verify at least one of the coverage options is enabled (checked) and contains required criteria, then re-send the data request.
NO GFDS Subscription	The system is not currently subscribed to GFDS, or the access code is incorrect. Verify the access code. Contact Garmin Flight Data Services at 1-866-739-5687 in the United States or 913-397-8200, ext. 1135 for assistance.
Reduce Request Area	The GFDS weather data request area exceeds size limits. Reduce weather coverage area and re-send data request.
Request Cancelled	The user has cancelled a GFDS weather data request.
Requested area too large. Reduce coverage area.	The size of the GFDS weather data request has exceeded limits. Reduce the size of the coverage area and try the weather data request again.
Request Failed - Try Again	The weather data request timed-out. Re-send data request.

Table 6-9 Abnormal GFDS Request Status Messages

WORLDWIDE WEATHER IN REVERSIONARY MODE

When the system is operating in Reversionary Mode, only those weather products which can be displayed on the PFD Inset map will be available for display (see Table 6-6 for a list of weather products and their associated map availability).

If manual weather data requests were enabled prior to entering Reversionary Mode, no new GFDS weather data can be retrieved while operating in Reversionary Mode. If automatic weather data requests were enabled prior to Reversionary Mode operation, the system will continue the automatic data requests in Reversionary Mode (provided automatic requests have not been inhibited due to a system error).

6.3 FIS-B WEATHER



NOTE: The Flight Information Service - Broadcast (FIS-B) weather data provides information for avoiding hazardous weather. Do not use FIS-B information to penetrate hazardous weather.

The optional GDL 90 receives Flight Information Services - Broadcast (FIS-B) weather data from a network of UAT (Universal Access Transceiver) ground-based transmitters. The system displays FIS-B graphical weather information and associated text on the Multi Function Display (MFD) and the Primary Flight Display (PFD) Inset Map.

FIS-B weather data reception requires the aircraft being within range and line-of-sight of an operating ground-based transceivers (GBT) broadcasting FIS-B weather data. Reception may be affected by factors including altitude or terrain.

Reception of FIS-B weather data occurs automatically without any pilot action. FIS-B broadcasts provide weather data in a repeating cycle which may take approximately ten minutes to transmit all available weather data. Therefore, not all available weather data may be available immediately upon initial FIS-B signal acquisition.

USING FIS-B WEATHER PRODUCTS

The primary map for viewing FIS-B Weather data is the Weather Data Link (FIS-B) Page in the Map Page Group.

Viewing the Weather Data Link (FIS-B) Page:

- 1) Turn the large **FMS** Knob to select the Map Page Group.
- 2) Turn the small **FMS** Knob to select the Weather Data Link (FIS-B, XM, or GFDS) Page.
- 3) If the page title displays a weather datalink source other than 'FIS-B', such as 'XM' or 'GFDS', proceed to the following steps to change the weather datalink source.
- 4) Press the **MENU** Key.
- 5) Turn the small **FMS** Knob to select 'Display FIS-B Weather' and press the **ENT** Key. The page title will display 'MAP - WEATHER DATA LINK (FIS-B)' to indicate FIS-B is now the selected weather datalink source.

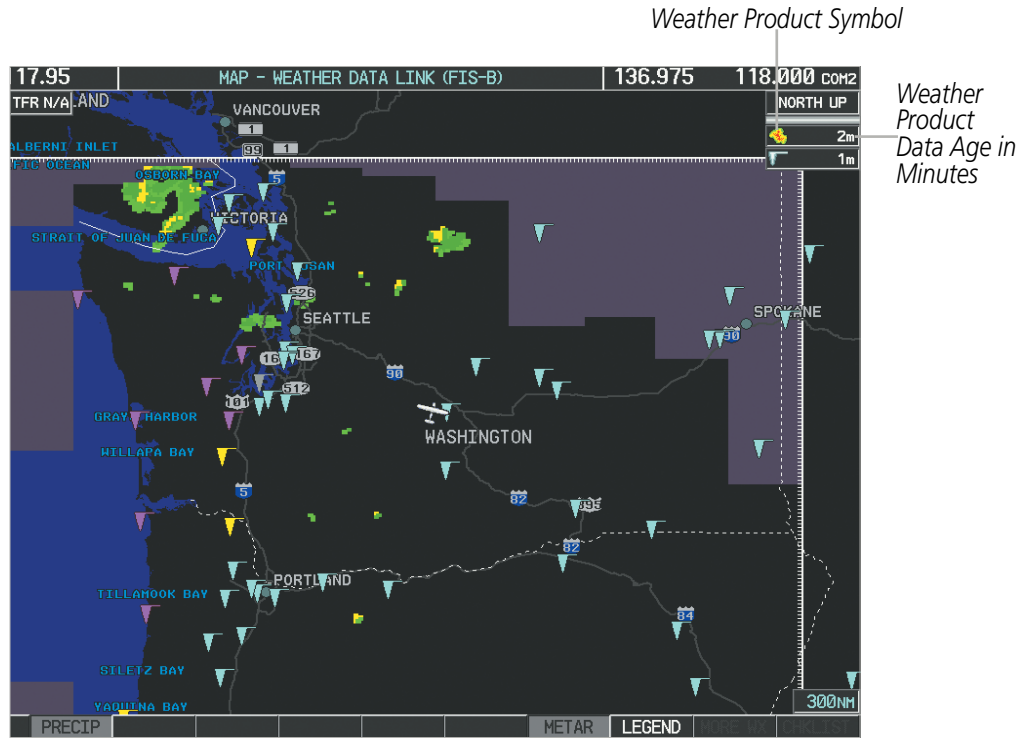

Figure 6-95 Weather Data Link (FIS-B) Page

When a FIS-B weather product is active on a map, the age of the data is displayed on the screen to the right of the product symbol (Figure 6-95). The age of the product is based on the time difference between when the data was assembled on the ground and the current GPS time. Weather products are refreshed at specific intervals (defined in the **Refresh Rate** column in Table 6-10).

If for any reason, a weather product is not refreshed within the **Expiration Time** intervals (see Table 6-10), the data is considered expired and is removed from the display. This ensures that the displayed data is consistent with FIS-B broadcast data. If more than half of the expiration time has elapsed, the color of the product age displayed changes to yellow. The system displays dashes instead of a product age when a product has expired. If a weather product is not available or has not been received, the system displays 'N/A' instead of a product age.

Table 6-10 shows the FIS-B weather product symbols, the expiration time and the refresh rate. The refresh rate represents the interval at which FIS-B GBTs broadcast new signals that may or may not contain new weather data. It does not represent the rate at which weather data is updated or new content is received by the GDL 90.

- SYSTEM OVERVIEW
- FLIGHT INSTRUMENTS
- EIS
- AUDIO PANEL & CNS
- FLIGHT MANAGEMENT
- HAZARD AVOIDANCE
- AFCS
- ADDITIONAL FEATURES
- APPENDICES
- INDEX

FIS-B Weather Product	Symbol	Expiration Time (Minutes)	Refresh Rate (Minutes)
Regional Radar Precipitation (PRECIP)		30	2.5
Meteorological Aerodrome Report (METARs)		90	5
Radar Coverage (RADAR CVRG)	no product image	30	2.5
Terminal Aerodrome Reports (TAFs)	no product image	60	10

Table 6-10 Weather Product Symbols and Data Timing

Table 6-11 shows which FIS-B weather products can be displayed (indicated with a '+' symbol) on specific maps.

FIS-B Weather Product	PFD Inset Map	Navigation Map Page	Weather Data Link (XM) Page	Weather Information Page	AUX - Trip Planning Page	AUX - Video Page	Nearest Page Group	Flight Plan Pages
PRECIP	+	+	+		+	+	+	+
METARs	+	+	+	+	+	+	+	+
TAFs			+	+				

Table 6-11 FIS-B Weather Product Display Maps

Softkeys control the display of weather information on most MFD pages and the PFD Inset Map (Figure 6-96) shows the weather product softkeys for the Weather Data Link (FIS-B) Page). When a weather product is selected for display, the corresponding softkey label changes to gray.

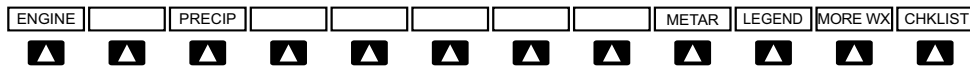

Figure 6-96 Weather Data Link Weather Product Softkeys (FIS-B)

The system can display weather data from multiple providers, however data for only one provider may be enabled for display at a time.

Selecting a weather datalink source for display:

- 1) Turn the large **FMS** Knob on the MFD to select the MAP page group.
- 2) Turn the small **FMS** Knob to select the Weather Data Link Page. The system displays the name of the currently selected weather source after the page title (FIS-B, GFDS, or XM). To change the weather data source, proceed to the next step.
- 3) Press the MENU Key.
- 4) Turn the large **FMS** Knob to highlight the selected weather service (FIS-B, GFDS, or XM) and press the **ENT** Key.

Maps besides the Weather Data Link (FIS-B) Page use settings based on those selected for the Navigation Map Page.

Setting up and customizing FIS-B weather data for the Navigation Map Page:

- 1) Select the Navigation Map Page.
- 2) Press the **MENU** Key.
- 3) With 'Map Setup' highlighted, press the **ENT** Key (Figure 6-97).
- 4) Turn the small **FMS** Knob to select the 'Weather' Group and press the **ENT** Key (Figure 6-98).
- 5) Turn the large **FMS** Knob or press the **ENT** Key to scroll through product selections (Figure 6-99).
- 6) Turn the small **FMS** Knob to scroll through options for each product (ON/OFF, range settings).
- 7) Press the **ENT** Key to select an option.
- 8) Press the **FMS** Knob or **CLR** Key to return to the Navigation Map Page with the changed settings.



Figure 6-97 Navigation Map Page Menu

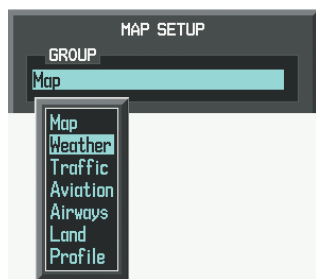

Figure 6-98 Navigation Map Page Setup Menu



Figure 6-99 Navigation Map Page Setup Menu, Weather Group

The setup menus for the Navigation Map Page and the Weather Data Link (FIS-B) Page control the map range settings above which weather products data are decluttered from the display. If a map range larger than the weather product map range setting is selected, the weather product data is removed from the map. The menus also provide a means in addition to the softkeys for enabling/disabling display of weather products.

Setting up and customizing the Weather Data Link (FIS-B) Page:

- 1) Select the Weather Data Link (FIS-B) Page.
- 2) Press the **MENU** Key.
- 3) With 'Weather Setup' highlighted, press the **ENT** Key (Figure 6-100).
- 4) Turn the small **FMS** Knob to select 'Product Group 1', and press the **ENT** Key (Figure 6-101).
- 5) Turn the large **FMS** Knob or press the **ENT** Key to scroll through product selections.
- 6) Turn the small **FMS** Knob to scroll through options for each product (ON/OFF, range settings, etc.).
- 7) Press the **ENT** Key to select an option.
- 8) Press the **FMS** Knob or **CLR** Key to return to the Weather Data Link (FIS-B) Page with the changed settings.



Figure 6-100 Weather Data Link Page (FIS-B) Menu



Figure 6-101 Weather Data Link Page Setup Menu

Restoring default Weather Data Link (FIS-B) Page settings:

- 1) Select the Weather Data Link (FIS-B) Page.
- 2) Press the **MENU** Key.
- 3) With 'Weather Setup' highlighted, press the **ENT** Key.
- 4) Press the **MENU** Key.
- 5) Highlight the desired default(s) to restore (all or for selection) and press **ENT** Key.

When a FIS-B weather product is enabled for display on the PFD Inset Map, the weather product information box (with the product icon and age) can be displayed inside the PFD Inset Map.

Displaying/removing the weather product information box on the PFD Inset Map:

- 1) On the PFD, press the **INSET** Softkey.
- 2) Press the **WX LGND** Softkey.
- 3) To remove the weather product information box, press the **WX LGND** Softkey again.

Each active weather product has an associated legend which can be displayed on the Weather Data Link (FIS-B) Page. A weather product legend can also be displayed on the Navigation Map Page for active FIS-B weather products displayed on that page.

Viewing legends for displayed weather products on the Weather Data Link (FIS-B) Page:

- 1) Select the Weather Data Link (FIS-B) Page.
- 2) Press the **LEGEND** Softkey to display the legends for the displayed weather products.
Or:
 - a) Press the **MENU** Key.
 - b) Select 'Weather Legend' and press the **ENT** Key.
- 3) To remove the Legend Window, press the **LEGEND** Softkey, the **ENT** or the **CLR** Key, or press the **FMS** Knob.

Viewing legends for displayed weather products (on the Navigation Map Page):

- 1) Select the Navigation Map Page.
- 2) Press the **MAP** Softkey.
- 3) Press the **LEGEND** Softkey (available if one or more FIS-B weather products are enabled for display).
- 4) To remove the Legend Window, press the **LEGEND** Softkey, the **ENT** or the **CLR** Key, or press the **FMS** Knob.

Additional information about METARs can be displayed by panning over a METAR flag on the map:

The map panning feature is enabled by pressing the **RANGE** Knob. The map range is adjusted by turning the **RANGE** Knob. If the map range is adjusted while panning is enabled, the map is re-centered on the Map Pointer.

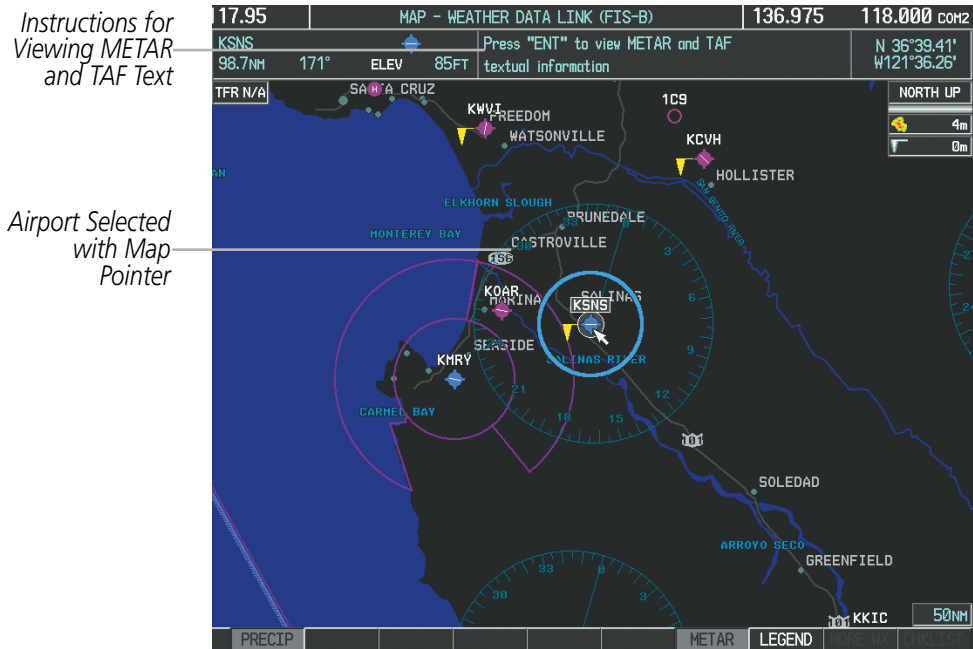

Figure 6-102 Panning on the Weather Data Link (FIS-B) Page

REGIONAL RADAR PRECIPITATION



NOTE: Regional Radar Precipitation data cannot be displayed at the same time as terrain.

FIS-B regional radar precipitation is based on WSR-88D, or NEXRAD (NEXt-generation RADar), a network of high-resolution Doppler radar systems that are operated by the National Weather Service (NWS). The maximum range of a single NEXRAD radar site is 250 nm. In addition to a wide array of services, the NEXRAD network provides important information about severe weather and air traffic safety.

Radar precipitation data is not real-time. The lapsed time between collection, processing, and dissemination of composite radar images can be significant and may not reflect the current radar synopsis. Due to the inherent delays and the relative age of the data, it should be used for long-range planning purposes only. Never use NEXRAD data or any radar data to penetrate hazardous weather. Rather, use it in an early-warning capacity of pre-departure and enroute evaluation.

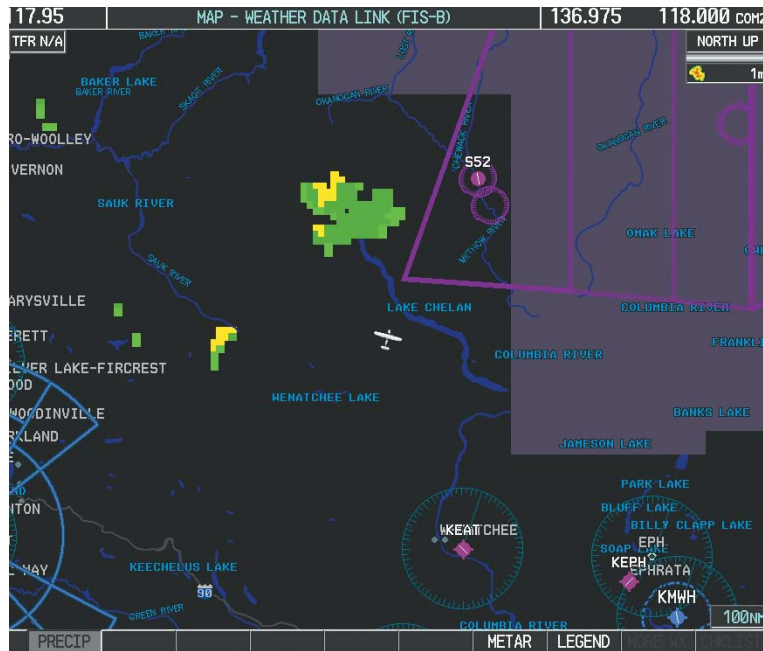

Figure 6-103 Regional Radar Precipitation Data on the Weather Data Link (FIS-B) Page

Regional Radar Precipitation data can be displayed on the following maps:

- PFD Inset Map
- Navigation Map Page
- Weather Data Link (FIS-B) Page
- Airport Information Page
- Trip Planning Page
- Nearest Pages
- Flight Plan Pages
- AUX - Video Page

Displaying Regional Radar Precipitation information:

- 1) Press the **MAP** Softkey (for the PFD Inset Map, press the **INSET** Softkey). This step is not necessary on the Weather Data Link (FIS-B) Page.
- 2) Press the **PRECIP** Softkey.

The Regional Radar Precipitation product coverage area varies, as it is determined by the data received from ground-based sources. When the Regional Radar Precipitation product is enabled, a white hashed boundary rectangle encloses this area to indicate the geographic limits of the regional radar coverage being displayed. The system shows composite radar data from all available NEXRAD sites inside of this boundary area.

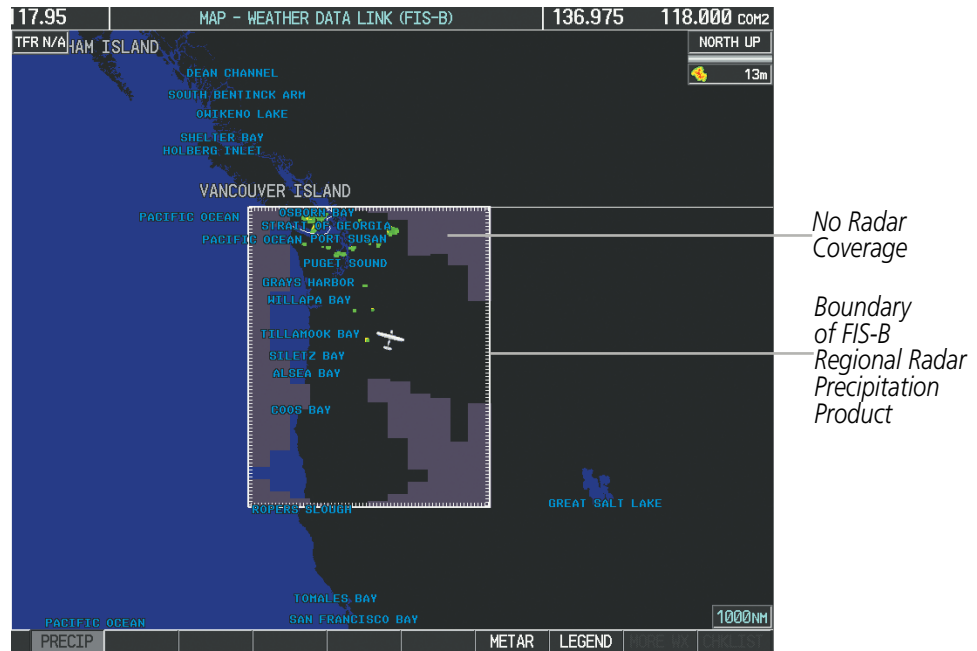

Figure 6-104 Regional Radar Precipitation Data on the Weather Data Link (FIS-B) Page

This data is composed of the maximum reflectivity from the individual radar sweeps. The display of the information is color-coded to indicate the weather severity level. All weather product legends can be viewed on the Weather Data Link (FIS-B) Page. For the Precipitation legend (Figure 6-105), press the **LEGEND** Softkey when Regional Radar Precipitation data is selected for display.

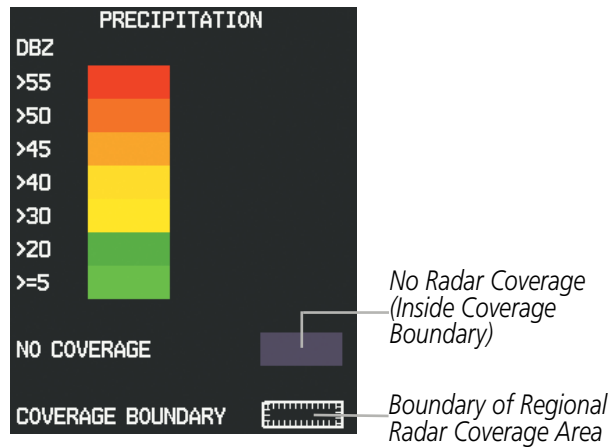

Figure 6-105 Regional Radar Precipitation Data Legend

The display of radar coverage is enabled when PRECIP is selected for display. Areas within the coverage boundary where radar precipitation data is not currently available, has not yet been received, or is not being collected are indicated in gray shade of purple.



NOTE: If the system has not received all available Regional Radar Precipitation data (such as during initial FIS-B signal acquisition), the system may temporarily display areas of no radar coverage which are subsequently removed as radar data is received. It may take up to approximately ten minutes to receive all FIS-B data.

REFLECTIVITY

Reflectivity is the amount of transmitted power returned to the radar receiver. Colors on the NEXRAD display are directly correlative to the level of detected reflectivity. Reflectivity as it relates to hazardous weather can be very complex.

The role of radar is essentially to detect moisture in the atmosphere. Simply put, certain types of weather reflect radar better than others. The intensity of a radar reflection is not necessarily an indication of the weather hazard level. For instance, wet hail returns a strong radar reflection, while dry hail does not. Both wet and dry hail can be extremely hazardous.

The different NEXRAD echo intensities are measured in decibels (dB) relative to reflectivity (Z). NEXRAD measures the radar reflectivity ratio, or the energy reflected *back to* the radar receiver (designated by the letter Z). The value of Z increases as the returned signal strength increases.

NEXRAD LIMITATIONS

NEXRAD radar images may have certain limitations:

- NEXRAD base reflectivity does not provide sufficient information to determine cloud layers or precipitation characteristics (wet hail vs. rain). For example, it is not possible to distinguish between wet snow, wet hail, and rain.
- NEXRAD base reflectivity is sampled at the minimum antenna elevation angle. An individual NEXRAD site cannot depict high altitude storms at close ranges. It has no information about storms directly over the radar site.
- When zoomed in to a range of 30 nm, each square block on the display represents an area of four square kilometers. The intensity level reflected by each square represents the *highest* level of NEXRAD data sampled within the area (Figure 6-106).

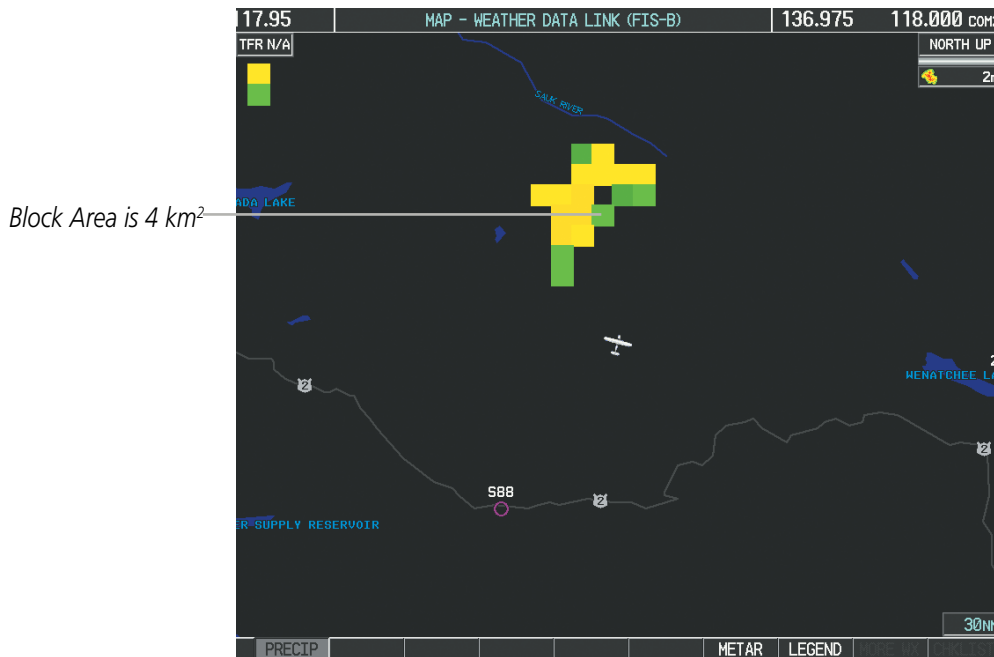

Figure 6-106 Regional Radar Data - Zoomed

The following may cause abnormalities in displayed NEXRAD radar images:

- Ground clutter
- Strokes and spurious radar data
- Sun strobes (when the radar antenna points directly at the sun)
- Interference from buildings or mountains, which may cause shadows
- Metallic dust from military aircraft, which can cause alterations in radar scans

METARS AND TAFS

NOTE: Atmospheric pressure is reported in inches of mercury (in Hg). Temperatures are reported in Celsius.

NOTE: The system will begin to display METAR flags as it receives reports; however it may take approximately ten minutes for all available METAR and TAF data to be received over a FIS-B broadcast.

Aviation Routine Weather Reports or METARs typically contain current information about the temperature, dewpoint, wind, precipitation, cloud cover, cloud heights, visibility, and barometric pressure at an airport or observation station. They can also contain information on precipitation amounts, lightning, and other critical data. METARs reflect routine hourly observations. An Aviation Selected Special Report or SPECI includes the code “SPECI” in the report, and may be issued if critical information has changed after the issuance of a METAR. The system displays colored flags at airports with report(s) available.

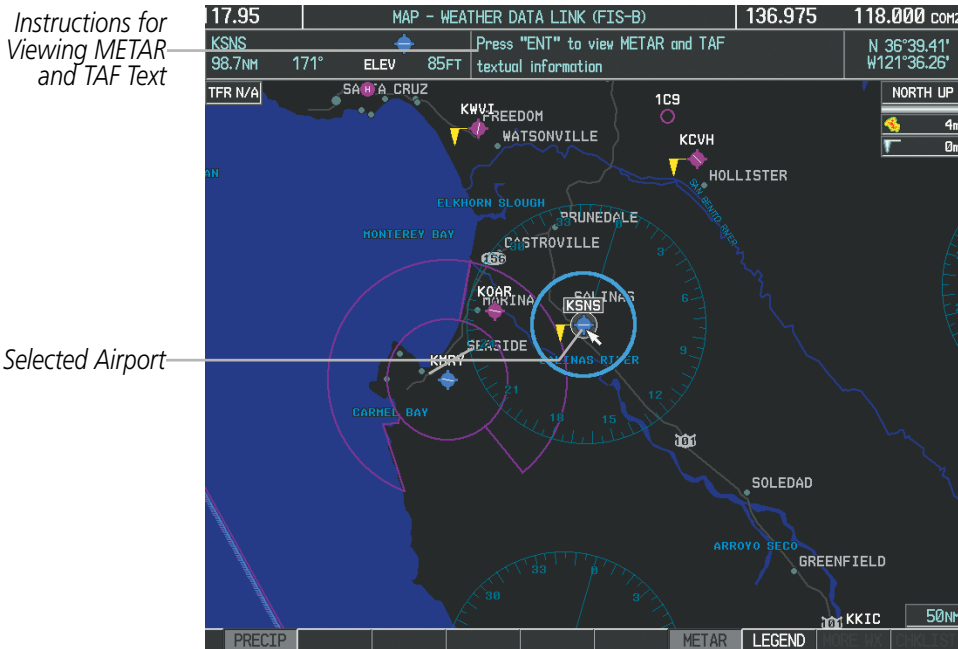

Figure 6-107 METAR Flags on the Weather Data Link Page

TAFs (Terminal Aerodrome Forecasts) are predications of expected weather conditions for an area within five statute miles of the center of an airport’s runway complex. The National Weather Service issues scheduled TAFs four times each day, and additional amended TAFs if conditions warrant. TAFs typically span a forecast period of 24 hours, but may be scheduled for a longer period. TAFs may include forecast wind, visibility, significant weather phenomena, and sky conditions using METAR codes.

METAR and TAF text are available on the Weather Information Page. METAR data is displayed first in a decoded fashion, then as raw text. TAF information, when available, appears only as raw text.

Displaying METAR and TAF text:

- 1) On the Weather Data Link (FIS-B) Page, press the **METAR** Softkey.
- 2) Press the **RANGE** Knob and pan to the desired airport.
- 3) Press the **ENT** Key. The Weather Information Page is shown with METAR and TAF text.
- 4) Use the **FMS** Knob or the **ENT** Key to scroll through the METAR and TAF text. METAR text must be completely scrolled through before scrolling through the TAF text.
- 5) Press the **FMS** Knob or the **CLR** Key to return to the Weather Data Link (FIS-B) Page.

Or:

- 1) Select the Weather Information Page.
 - a) Turn the large **FMS** Knob to select the Waypoint Page Group.
 - b) Press the **WX** Softkey to select the Weather Information Page.
- 2) Press the **FMS** Knob to display the cursor.
- 3) Use the **FMS** Knob to enter the desired airport and press the **ENT** Key.
- 4) Use the **FMS** Knob or the **ENT** Key to scroll through the METAR and TAF text. Note that the METAR text must be completely scrolled through before scrolling through the TAF text.

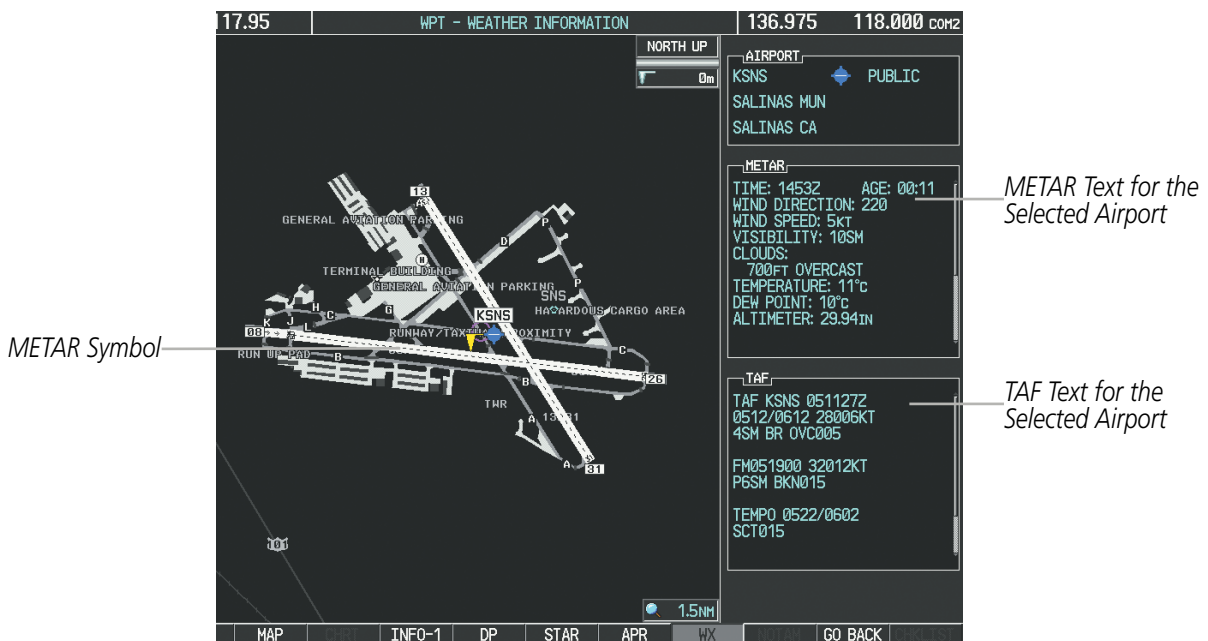

Figure 6-108 METAR and TAF Text on the Weather Information Page

Raw METAR text is also accessible while panning the map cursor over a METAR flag on any map page on which a METAR is displayed. The METAR text is shown in a box near the METAR flag.

In addition, METAR flags and their associated text are displayed on the Active Flight Plan Page on the MFD. METAR flags appears next to waypoints in the flight plan with an associated METAR. A solid light blue

METAR flag indicates the METAR observations are available for specific waypoint; a hollow light blue METAR flag indicates an off-route METAR is available near the waypoint.

Displaying raw METAR text on the Active Flight Plan Page:

- 1) Select the Active Flight Plan Page on the MFD.
- 2) Press the **FMS** Knob to activate the cursor.
- 3) Turn the large **FMS** Knob to highlight the desired waypoint. The METAR text will appear in the 'SELECTED WAYPOINT WEATHER' window below.
- 4) When finished, press the **FMS** Knob to remove the cursor or press the **FPL** Key to exit the Active Flight Plan Page.

To display the METAR legend on the Weather Data Link (FIS-B) Page (Figure 6-109), press the **LEGEND** Softkey when METARs are selected for display.

The METAR flag color is determined by the information in the METAR text. The system displays a gray METAR flag when the METAR text does not contain adequate classification information.



Figure 6-109 METAR Legend

6.4 WX-500 STORMSCOPE

NOTE: The L-3 WX-500 Stormscope® system is not intended for hazardous thunderstorm penetration. Weather information on the G1000 MFD is approved for weather avoidance only. Refer to the WX-500 Pilot's Guide for a detailed description of Stormscope operation.

NOTE: Stormscope lightning data cannot be displayed at the same time as lightning data from XM WX or GFDS datalink weather sources.

The following pages can display Stormscope data:

- Stormscope Page
- Navigation Map
- AUX - Trip Planning Page
- Nearest Pages

To display Stormscope data on the Navigation Map, AUX - Trip Planning Page, or any of the Nearest Pages, press the **MAP** Softkey, then press the **STRMSCP** Softkey. These pages can also display cell or strike data using the yellow lightning strike symbology shown in Table 6-12.





Lightning Age	Symbol
Strike is less than 6 seconds old	
Strike is between 6 and 60 seconds old	
Strike is between 1 and 2 minutes old	
Strike is between 2 and 3 minutes old	

Table 6-12 Lightning Age and Symbols

SETTING UP STORMSCOPE ON THE NAVIGATION MAP

Setting up Stormscope options on the Navigation Map:

- 1) On the Navigation Map Page, press the **MENU** Key.
- 2) With 'Map Setup' selected (Figure 6-110), press the **ENT** Key.
- 3) Turn the small **FMS** Knob to display the group selection window. Turn the small **FMS** Knob to select 'Weather', and press the **ENT** Key.
- 4) Turn the large **FMS** Knob to highlight and move between the product selections (Figure 6-111).
- 5) When an item is highlighted, turn the small **FMS** Knob to select the option.
- 6) Press the **ENT** Key.
- 7) Press the **FMS** Knob to return to the Navigation Map Page (Figure 6-112).

The following options are available (Figure 6-111):

- **STRMSCP LTNG** – Turns the display of Stormscope data on or off.
- **STRMSCP MODE** – Selects the CELL or STRIKE mode of lightning activity. Cell mode identifies clusters or cells of electrical activity. Strike mode indicates the approximate location of lightning strikes.
- **STRMSCP SMBL** – Selects the range at which Stormscope data displays. Stormscope data is removed when a map range greater than the STRMSCP SMBL value is selected.



Figure 6-110 Page Menu

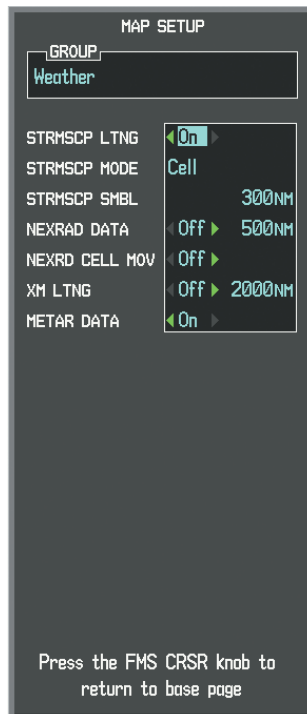

Figure 6-111 Map Setup Menu

SYSTEM OVERVIEW

FLIGHT INSTRUMENTS

EIS

AUDIO PANEL & CNS

FLIGHT MANAGEMENT

HAZARD AVOIDANCE

AFCS

ADDITIONAL FEATURES

APPENDICES

INDEX

CELL AND STRIKE MODE ON THE NAVIGATION MAP

On the Navigation Map, cell mode identifies cells of lightning activity (Figure 6-112). Stormscope identifies clusters of electrical activity that indicate cells. Strike mode indicates the approximate location of lightning strikes.

Selecting the 'cell' or 'strike' mode on the Navigation Map:

- 1) Press the **MENU** Key.
- 2) With 'Map Setup' selected, press the **ENT** Key.
- 3) Select the 'Weather' group.
- 4) Press the **ENT** Key. The cursor flashes on 'STRMSCP LTNG'.
- 5) Turn the **large FMS** Knob to select 'STRMSCP MODE'.
- 6) Turn the **small FMS** Knob to change between 'CELL' and 'STRIKE' options. When an item is selected, press the **ENT** Key.
- 7) Press the **FMS** knob to return to the Navigation Map Page.

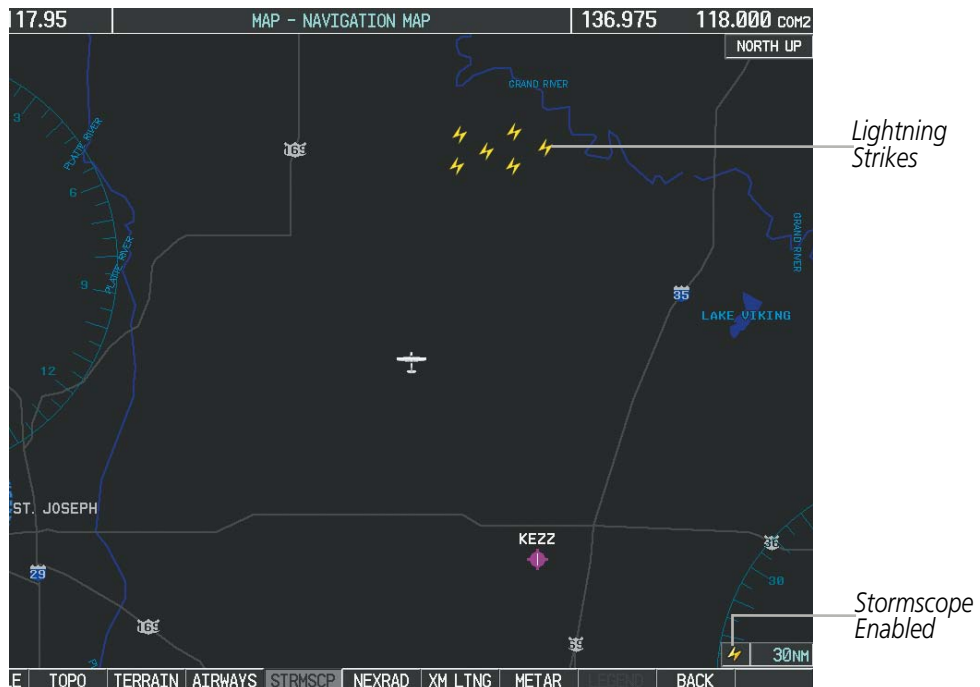

Figure 6-112 Navigation Map Page with Stormscope Lightning Data

If heading input is lost, strikes and/or cells must be cleared manually after the execution of each turn (Figure 6-113). This is to ensure that the strike and/or cell positions are depicted accurately in relation to the nose of the aircraft.

Manually clearing Stormscope data on the Navigation Map:

- 1) Press the **MENU** Key.
- 2) Select 'Clear Stormscope® Lightning'.
- 3) Press the **ENT** Key.



Figure 6-113 Navigation Map Page Options Menu

ZOOM RANGE ON THE NAVIGATION MAP

Stormscope lightning data can be displayed up to 800 nm zoom range (in North up mode) on the Navigation Map Page. **However, in the track up mode at the 500 nm range, a portion of Stormscope lightning data can be behind the aircraft and therefore not visible on the Navigation Map.** Since the range for Stormscope data is 400 nm diameter total (200 nm in front and 200 nm behind), the 500 nm range in North up mode shows all the data.

At a map range of less than 25 nm, Stormscope lightning data is not displayed, but can still be present.

The maximum zoom range can also be set on the Navigation Map. Note that Stormscope data above the selected maximum zoom range is decluttered.

Selecting a Stormscope range on the Navigation Map:

- 1) Press the **MENU** Key.
- 2) Select 'MAP SETUP'.
- 3) Select the 'Weather' group.
- 4) Press the **ENT** Key.
- 5) Turn the **large FMS** Knob to select 'STRMSCP SMBL'.
- 6) Turn the **small FMS** Knob to select the maximum display range.
- 7) Press the **ENT** Key.
- 8) Press the **FMS** Knob to return to the Navigation Map Page.

To change the display range on the Navigation Map Page, turn the **RANGE** Knob clockwise to zoom out or counter-clockwise to zoom in.

SELECTING THE STORMSCOPE PAGE

Stormscope lightning data can be displayed at the ranges of 25 nm, 50 nm, 100 nm, and 200 nm.

Adjusting the Stormscope Map Range:

- 1) Turn the large **FMS** Knob to select the Map Page Group.
- 2) Turn the small **FMS** Knob to select the Stormscope Page.
- 3) To change the map range, turn the **RANGE** Knob clockwise to zoom out or counter-clockwise to zoom in.

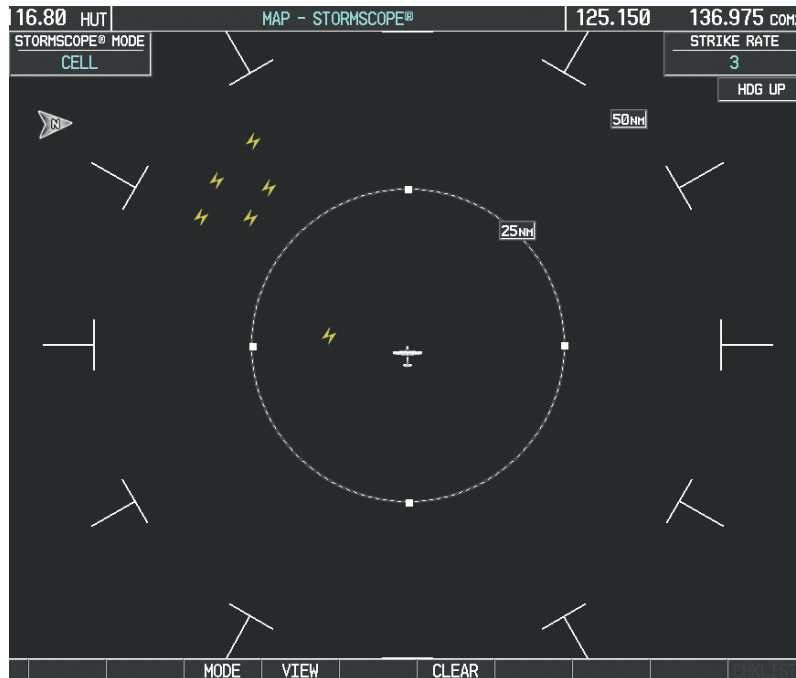

Figure 6-114 Stormscope Page

Changing between 'cell' and 'strike' mode on the Stormscope Page:

- 1) Select the Stormscope Page.
- 2) Press the **MODE** Softkey. The **CELL** and **STRIKE** softkeys are displayed.
- 3) Press the **CELL** Softkey to display 'CELL' data or press the **STRIKE** Softkey to display 'STRIKE' data. 'CELL' or 'STRIKE' is displayed in the mode box in the upper left corner of the Stormscope Page.
- 4) Press the **BACK** Softkey to return to the main Stormscope page.

Changing the viewing mode between 360° and 120° on the Stormscope Page:

- 1) Select the Stormscope Page.
- 2) Press the **VIEW** Softkey. The **360** and **ARC** softkeys are displayed. Press the **360** Softkey to display a 360° viewing area or press the **ARC** Softkey to display a 120° viewing area.
- 3) Press the **BACK** Softkey to return to the main Stormscope page.

6.5 TERRAIN PROXIMITY



WARNING: Do not use Terrain Proximity information for primary terrain avoidance. Terrain Proximity is intended only to enhance situational awareness.



NOTE: Terrain data is not displayed if the aircraft is outside of the installed terrain database coverage area.

G1000 Terrain Proximity is a terrain awareness system that does not comply with TSO-C151b certification standards. It increases situational awareness and aids in reducing controlled flight into terrain (CFIT). Do not confuse Terrain Proximity with the optional Terrain Awareness and Warning System - Class B (TAWS-B). TAWS-B is more sophisticated and robust, and it is TSO-C151b certified. Terrain Proximity does not provide warning annunciations or voice alerts. It only provides color indications on map displays when terrain and obstacles are within a certain altitude threshold from the aircraft. Although the terrain and obstacle color map displays are the same, TAWS-B uses more sophisticated algorithms to assess aircraft distance from terrain and obstacles.

Terrain Proximity requires the following components to operate properly:

- Valid 3-D GPS position
- Valid terrain/obstacle database

Terrain Proximity displays altitudes of terrain and obstructions relative to the aircraft position and altitude with reference to a database that may contain inaccuracies. Terrain and obstructions are shown only if they are in the database. Terrain and obstacle information should be used as an aid to situational awareness. They should never be used to navigate or maneuver around terrain.

Note that all obstructions may not be available in the terrain and obstacle database. No terrain and obstacle information is shown without a valid 3-D GPS position.

The G1000 GPS receiver provides the horizontal position and altitude. GPS altitude is derived from satellite position. GPS altitude is then converted to the height above geodetic sea level (GSL), which is the height above mean sea level calculated geometrically. GSL altitude is used to determine terrain and obstacle proximity. GSL altitude accuracy is affected by satellite geometry, but is not subject to variations in pressure and temperature that normally affect pressure altitude sensors. GSL altitude does not require local altimeter settings to determine MSL altitude. It is a widely-used MSL altitude source.

Terrain and obstacle databases are referenced to MSL. Using the GPS position and altitude, the Terrain Proximity feature portrays a 2-D picture of the surrounding terrain and obstacles relative to the position and altitude of the aircraft. GPS position and GSL altitude are used to calculate and predict the aircraft's flight path in relation to the surrounding terrain and obstacles. In this way, the pilot can view predicted dangerous terrain and obstacle conditions.

DISPLAYING TERRAIN PROXIMITY DATA

The symbols and colors in Figure 6-115 and Table 6-13 are used to represent obstacles and aircraft altitude when the Terrain Proximity Page is selected for display. Terrain Proximity uses black, yellow, and red to represent terrain information relative to aircraft altitude. The color of each obstacle is associated with the altitude of the aircraft.

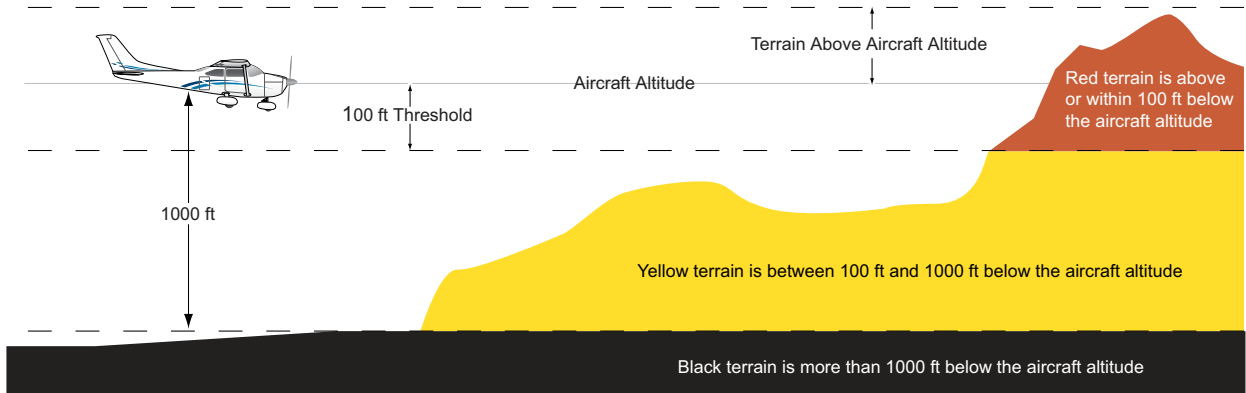

Figure 6-115 Terrain Altitude/Color Correlation for Terrain Proximity

Unlighted Obstacle		Lighted Obstacle		Obstacle Location
< 1000' AGL	> 1000' AGL	< 1000' AGL	> 1000' AGL	
				Red obstacle is above or within 100 ft below the aircraft altitude
				Yellow obstacle is between 100 ft and 1000 ft below the aircraft altitude

Table 6-13 Terrain Proximity Terrain/Obstacle Colors and Symbology

Terrain and obstacle information can be displayed on the following pages:

- PFD Inset Map
- Navigation Map Page
- Terrain Proximity Page
- Trip Planning Page
- Active Flight Plan Page
- Video Page

Displaying terrain and obstacle information (maps other than the Terrain Proximity Page):

- 1) Press the **MAP** Softkey (for the PFD Inset Map, press the **INSET** Softkey).
- 2) Press the **TERRAIN** Softkey to display terrain and obstacle data.

When Terrain Proximity is selected on maps other than the Terrain Proximity Page, an icon to indicate the feature is enabled for display and a legend for Terrain Proximity colors are shown (Figure 6-119).

The Navigation Map Page Setup Menu provides a means in addition to the softkey for enabling/disabling display of terrain and obstacles. The setup menu also controls the map range settings above which terrain and obstacle data are decluttered from the display. If a map range larger than the map range setting is selected, the data is removed from the map.

Terrain data can be selected for display independently of obstacle data; however, obstacles recognized by Terrain Proximity as yellow or red are shown when terrain is selected for display and the map range is within the setting limit.

Maps besides the Terrain Proximity Page use settings based on those selected for the Navigation Map Page. The maximum display ranges for obstacles on each map are dependent on the range setting made for the

Navigation Map. If the maximum range for obstacle display on the Navigation Map is adjusted to below 20 nm, the highest obstacle display range settings on the other applicable maps are also adjusted proportionally.



CAUTION: Terrain and obstacle data will not be displayed when the Navigation Map range is larger than the MAP SETUP range setting for TERRAIN DATA and OBSTACLE DATA.

Customizing terrain and obstacle display on the Navigation Map Page:

- 1) Select the Navigation Map Page.
- 2) Press the **MENU** Key.
- 3) With 'Map Setup' highlighted, press the **ENT** Key (Figure 6-116).
- 4) Turn the small **FMS** Knob to select the 'Map' Group and press the **ENT** Key (Figure 6-117).
- 5) Turn the large **FMS** Knob or press the **ENT** Key to scroll through product selections (Figure 6-118).
 - TERRAIN DATA – Turns the display of terrain data on or off and sets maximum range at which terrain is shown
 - OBSTACLE DATA – Turns the display of obstacle data on or off and sets maximum range at which obstacles are shown
- 6) Turn the small **FMS** Knob to scroll through options for each product (ON/OFF, range settings).
- 7) Press the **ENT** Key to select an option.
- 8) Press the **FMS** Knob or **CLR** Key to return to the Navigation Map Page with the changed settings.

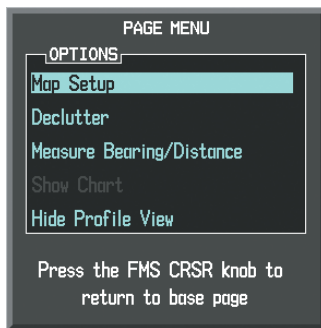

Figure 6-116 Navigation Map Page Menu



Figure 6-117 Navigation Map Page Setup Menu

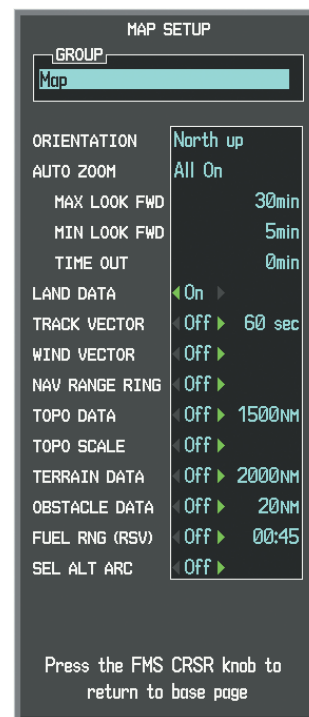

Figure 6-118 Navigation Map Page Setup Menu, Map Group

Additional information about obstacles can be displayed by panning over the display on the map. The map panning feature is enabled by pressing the **RANGE** Knob. The map range is adjusted by turning the **RANGE** Knob. If the map range is adjusted while panning is enabled, the map is re-centered on the Map Pointer.

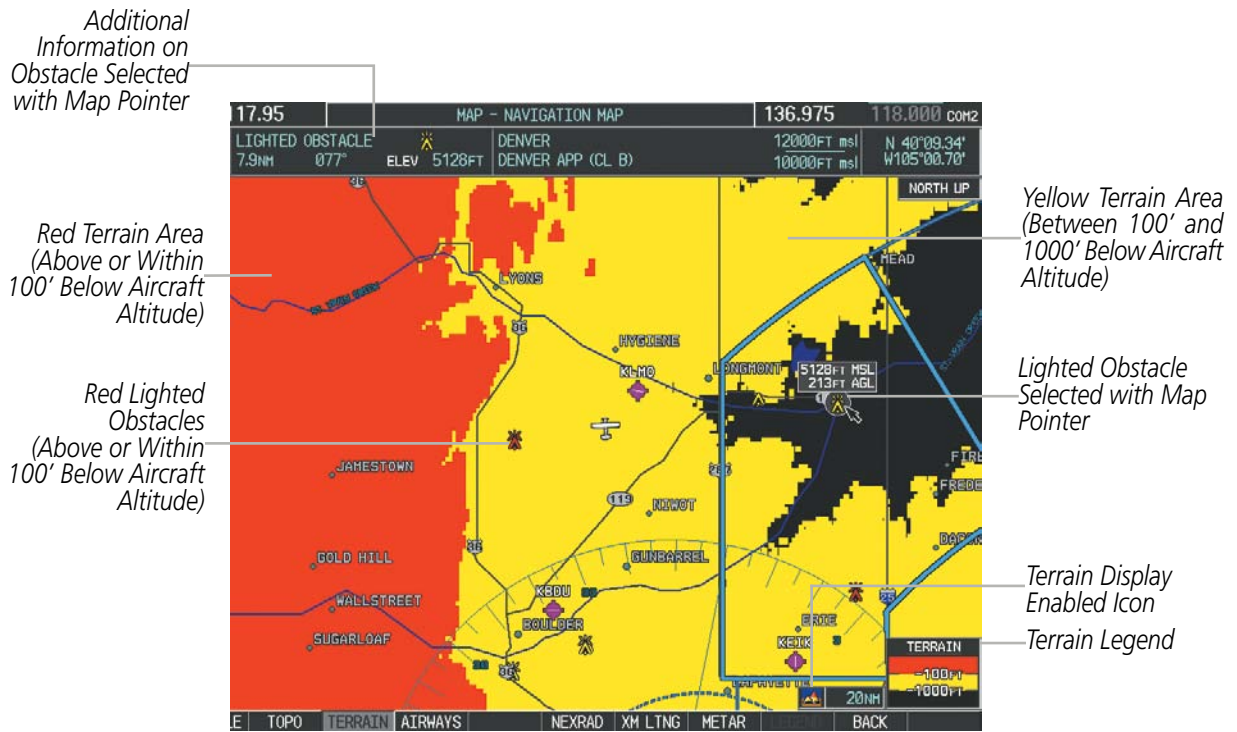

Figure 6-119 Terrain Information on the Navigation Map Page

TERRAIN PROXIMITY PAGE

The Terrain Proximity Page is specialized to show terrain and obstacle data in relation to the aircraft's current altitude, without clutter from the basemap. Aviation data (airports, VORs, and other NAVAIDs) can be displayed for reference.

Aircraft orientation on this map is always heading up unless there is no valid heading. Two views are available relative to the position of the aircraft: the 360° default display and the radar-like ARC (120°) display. Map range is adjustable with the **RANGE** Knob from 1 to 200 nm, as indicated by the map range rings (or arcs).

Displaying the Terrain Proximity Page:

- 1) Turn the large **FMS** Knob to select the Map Page Group.
- 2) Turn the small **FMS** Knob to select the Terrain Proximity Page.
- 3) To change the view,
 - a) Press the **VIEW** Softkey.
 - b) Press the **360** or **ARC** Softkey to select the desired view.

Or:

 - a) Press the **MENU** Key.
 - b) Select 'View Arc' or 'View 360°' (choice dependent on current state) and press the **ENT** Key to change the view.

Showing/hiding aviation information on the Terrain Proximity Page:

- 1) Press the **MENU** Key.
- 2) Select 'Show Aviation Data' or 'Hide Aviation Data' (choice dependent on current state) and press the **ENT** Key.

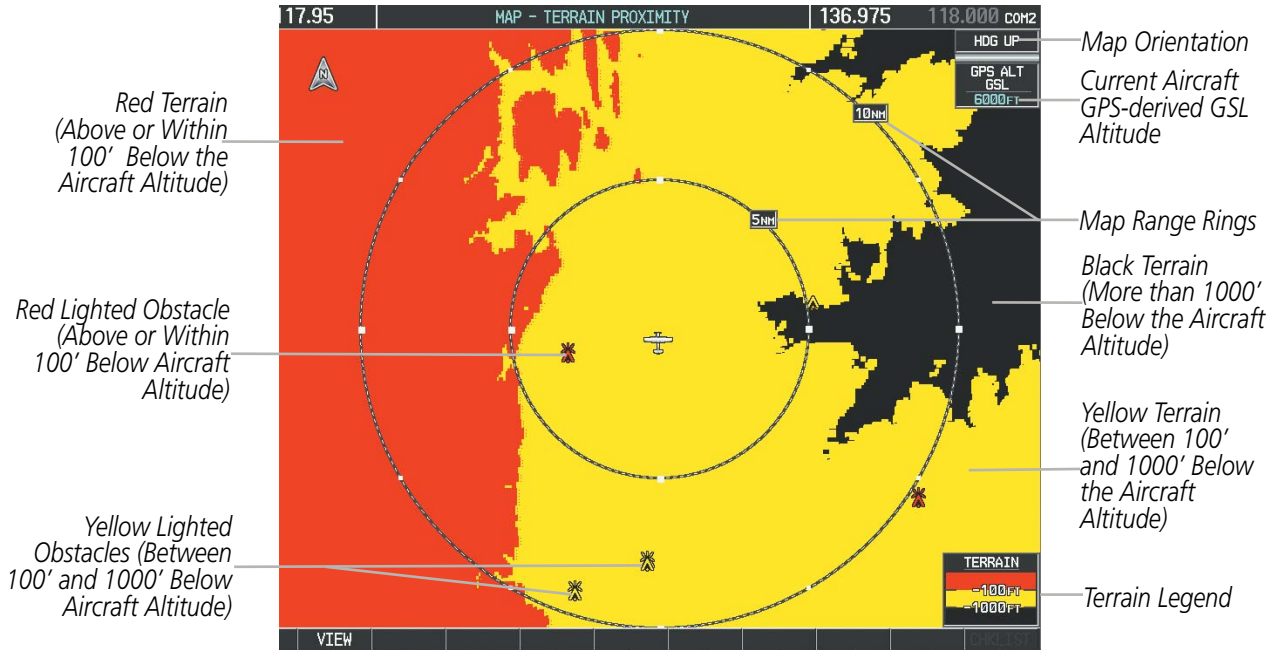

Figure 6-120 Terrain Proximity Page

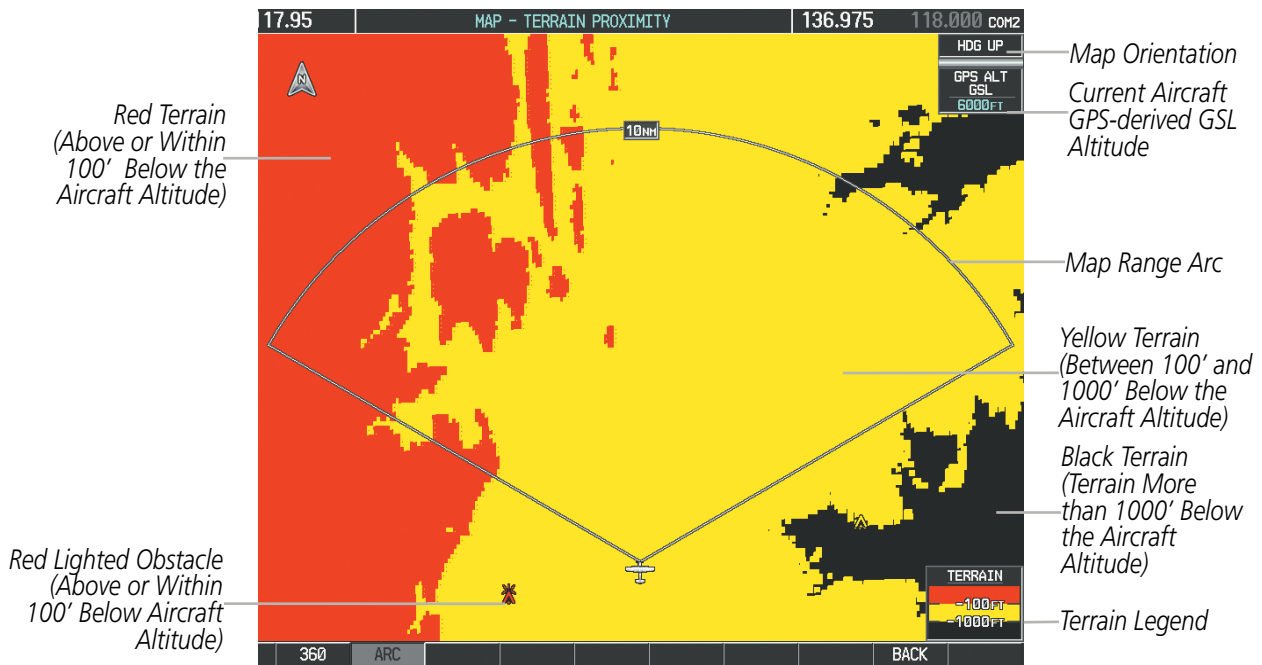

Figure 6-121 Terrain Proximity Page (ARC View)

6.6 PROFILE VIEW TERRAIN



WARNING: Do not use Profile View Terrain data for primary terrain avoidance. Profile View Terrain is intended only to enhance situational awareness.



NOTE: Terrain data is not displayed when the aircraft is outside of the installed terrain database coverage area.

The G1000 offers a Profile View of terrain and obstacles relative to the aircraft's current flight path and altitude on the Navigation Map Page of the MFD. Profile View does not provide terrain or obstacle caution or warning annunciations or voice alerts, nor does it display potential impact points inside the Profile View. The colors and symbols used to represent terrain and obstacles are the same as those used in Terrain Proximity discussed previously.

Accessing Profile View:

- 1) Select the Navigation Map Page.
- 2) Press the **MAP** Softkey.
- 3) Press the **PROFILE** Softkey to enable or disable Profile View.

Or:

- 1) Press the **MENU** Key.
- 2) Select 'Show Profile View' or 'Hide Profile View' (choice dependent on current state) and press the **ENT** Key.

Enabling/Disabling Profile View Terrain on the Navigation Map (when Profile View is enabled):

- 1) Select the Navigation Map Page.
- 2) Press the **MAP** Softkey.
- 3) Press the **TERRAIN** Softkey.

PROFILE VIEW DISPLAY

When the Profile View is enabled, it is displayed in a window below the Navigation Map. Altitude is shown along a vertical scale, with an aircraft icon positioned at the current altitude. Distance is represented horizontally along the bottom of the Profile View, and increases from left (present position) to right.

When the Navigation Map range is adjusted with the **RANGE** Knob, the horizontal distance of the Profile View is adjusted proportionately to be 1/2 of the Navigation Map range distance down to 1 nm, at which point Profile View is no longer available ('PROFILE NOT AVAILABLE' is displayed). When Navigation Map range is adjusted to remove altitude-correlated colored terrain data (as shown in the Terrain Legend) or obstacles from the Navigation Map, these items are also removed from the Profile View; only an outline of the terrain will be displayed in black in the Profile View window. Refer to the Terrain Proximity, Terrain-SVS, or TAWS-B discussions for more information about displaying terrain or obstacles on the Navigation Map Page.

- SYSTEM OVERVIEW
- FLIGHT INSTRUMENTS
- EIS
- AUDIO PANEL & CNS
- FLIGHT MANAGEMENT
- HAZARD AVOIDANCE
- AFCS
- ADDITIONAL FEATURES
- APPENDICES
- INDEX

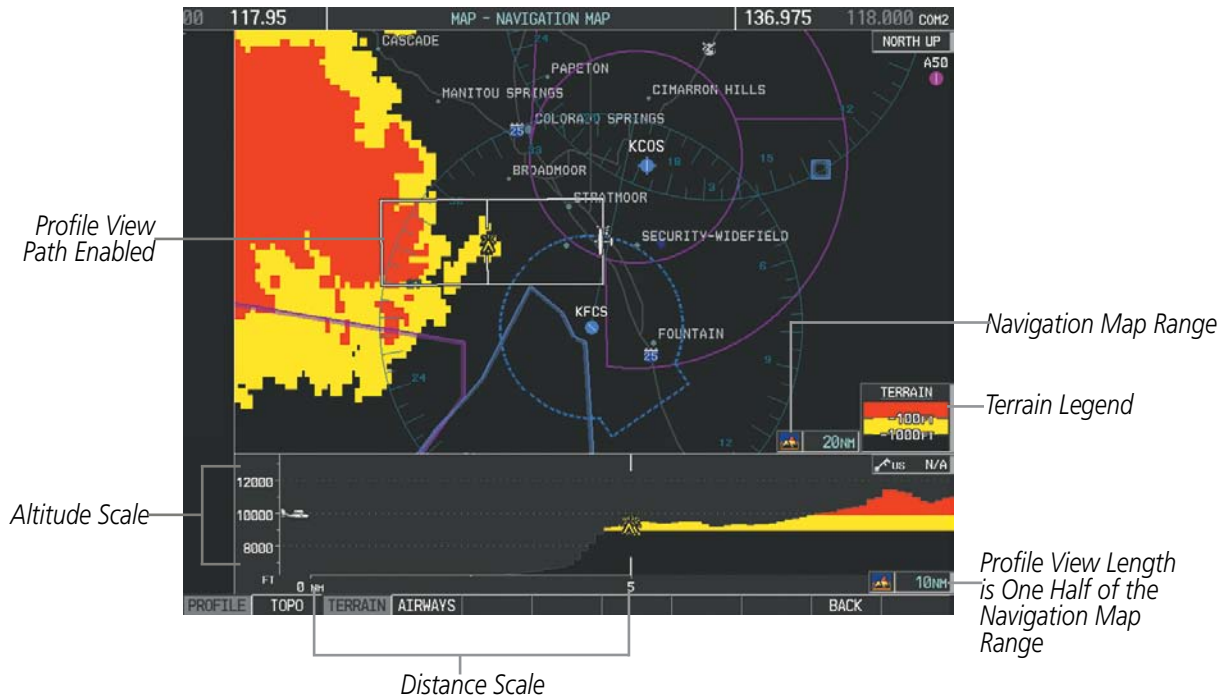

Figure 6-122 Profile View on Navigation Map with Terrain Display Enabled

The Profile View is based on the current aircraft track (or heading if track is unavailable) and shows the *highest* known terrain or obstacles within a predetermined width from the present aircraft position to the end of the profile range. The width of the Profile View (Table 6-14) is determined by the phase of flight, as annunciated on the HSI. Refer to the Flight Instruments section for more information about flight phases.

Flight Phase	Total Profile View Width
Approach	0.6 nm
Departure	0.6 nm
Terminal	2.0 nm
Enroute	4.0 nm
Oceanic	4.0 nm

Table 6-14 Profile View Width Scale

PROFILE PATH

The Profile Path displays the horizontal and lateral boundaries of the Profile View. The path is shown as a white rectangle on the Navigation Map Page (Figure 6-122) and is only available when Profile View is enabled. White range markers both edges of the Profile Path rectangle match the range markers along the distance scale inside the Profile View display window whenever the profile range is at least 4 nm (or 7.5 km if configured for metric units).

The Profile Path rectangle may be configured on or off, and the Navigation Map range at which the Profile Path is removed from map display can be changed.



CAUTION: Terrain and obstacle data will not be displayed when the Navigation Map range is larger than the MAP SETUP range setting for TERRAIN DATA and OBSTACLE DATA.

Customizing the Profile Path display on the Navigation Map Page:

- 1) Select the Navigation Map Page.
- 2) Press the **MENU** Key.
- 3) With 'Map Setup' highlighted, press the **ENT** Key (Figure 6-123).
- 4) Turn the small **FMS** Knob to select the 'Profile' Group and press the **ENT** Key (Figure 6-124).
- 5) Turn the large **FMS** Knob or press the **ENT** Key to scroll through product selections (Figure 6-125).
 - PROFILE PATH – Turns the display of the Profile Path on or off and sets maximum map range at which the Profile Path is shown
- 6) Turn the small **FMS** Knob to scroll through options (ON/OFF, range settings).
- 7) Press the **ENT** Key to select an option.
- 8) Press the **FMS** Knob or **CLR** Key to return to the Navigation Map Page with the changed settings.

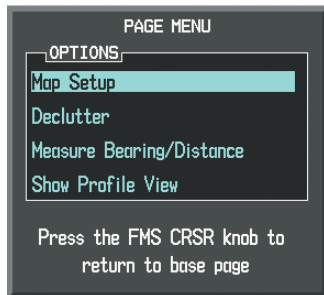

Figure 6-123 Navigation Map Page Menu

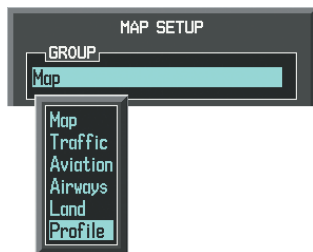

Figure 6-124 Navigation Map Page Setup Menu

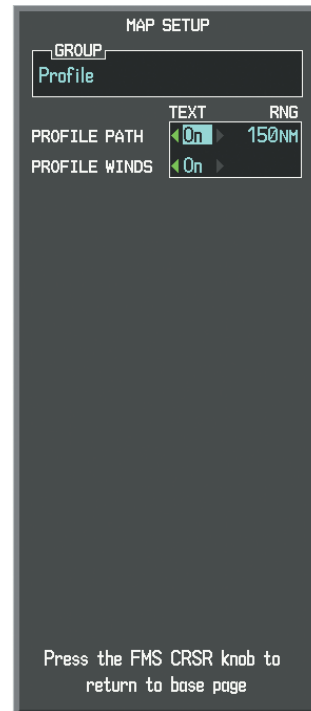

Figure 6-125 Navigation Map Page Setup Menu, Profile Group

6.7 TERRAIN-SVS



WARNING: Do not use TERRAIN-SVS information for primary terrain avoidance. TERRAIN-SVS is intended only to enhance situational awareness.



NOTE: Terrain data is not displayed when the aircraft is outside of the installed terrain database coverage area.



NOTE: Terrain-SVS is standard when the Synthetic Vision System (SVS) option is installed. The TAWS-B option will take precedence over Terrain-SVS when TAWS-B is installed.

Terrain-SVS is a terrain awareness system available with the Synthetic Vision System (SVS). SVS functionality is offered as an optional enhancement. The optional Terrain Awareness and Warning System - Class B (TAWS-B) or standard Terrain-SVS is integrated within SVS to provide visual and auditory alerts to indicate the presence of threatening terrain relevant to the projected flight path. For detailed information regarding SVS, refer to the Additional Features section of this Pilot's Guide.

Terrain-SVS does not comply with TSO-C151b certification standards. It increases situational awareness and aids in reducing controlled flight into terrain (CFIT). Do not confuse Terrain-SVS with TAWS-B. TAWS-B is more sophisticated and robust, and it is TSO-C151b certified. Although the terrain and obstacle color map displays are the same, TAWS-B uses more sophisticated algorithms to assess aircraft distance from terrain and obstacles.

Terrain-SVS does not provide the following:

- Premature Descent Alerting (PDA)
- Excessive Descent Rate (EDR)
- Negative Climb Rate (NCR)
- Descent to 500 Feet Callout (DFC)

Terrain-SVS requires the following components to operate properly:

- Valid 3-D GPS position
- Valid terrain/airport terrain/obstacle database

Terrain-SVS displays altitudes of terrain and obstructions relative to the aircraft position and altitude with reference to a database that may contain inaccuracies. Terrain and obstructions are shown only if they are in the database. Terrain and obstacle information should be used as an aid to situational awareness. They should never be used to navigate or maneuver around terrain.

Note that all obstructions may not be available in the terrain and obstacle database. No terrain and obstacle information is shown without a valid 3-D GPS position.

The G1000 GPS receiver provides the horizontal position and altitude. GPS altitude is derived from satellite position. GPS altitude is then converted to the height above geodetic sea level (GSL), which is the height above mean sea level calculated geometrically. GSL altitude is used to determine terrain and obstacle proximity. GSL altitude accuracy is affected by satellite geometry, but is not subject to variations in pressure and temperature that

normally affect pressure altitude sensors. GSL altitude does not require local altimeter settings to determine MSL altitude. It is a widely-used MSL altitude source.

Terrain and obstacle databases are referenced to GSL. Using the GPS position and altitude, the Terrain-SVS feature portrays a 3-D picture of the surrounding terrain and obstacles relative to the position and altitude of the aircraft. GPS position and GSL altitude are used to calculate and predict the aircraft's flight path in relation to the surrounding terrain and obstacles. In this way, the pilot can view predicted dangerous terrain and obstacle conditions.

DISPLAYING TERRAIN-SVS DATA

Terrain-SVS uses yellow (caution) and red (warning) to depict terrain and obstacles (with heights greater than 200 feet above ground level, AGL) alerts relative to aircraft altitude. Colors are adjusted automatically as the aircraft altitude changes. The colors and symbols in Figure 6-126 and Tables 6-15 and 6-16 are used to represent terrain, obstacles, and potential impact points.

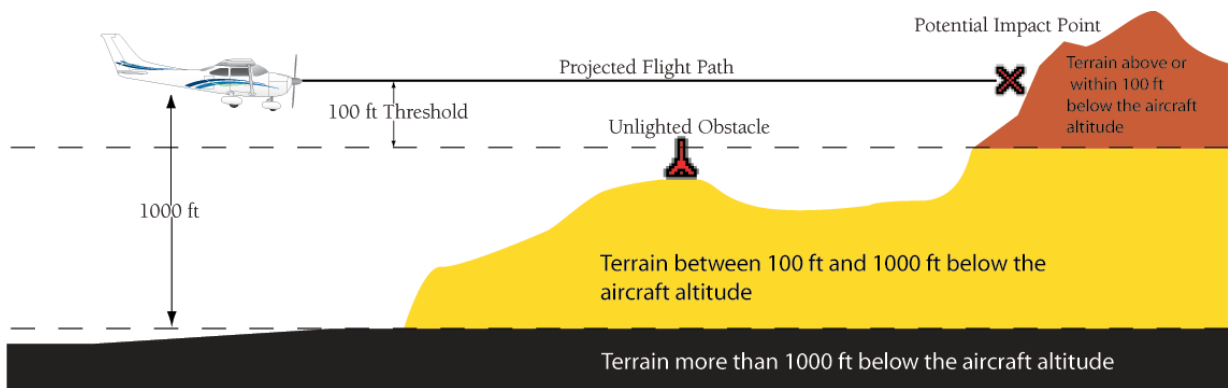

Figure 6-126 Terrain Altitude/Color Correlation for Terrain-SVS

Unlighted Obstacle		Lighted Obstacle		Obstacle Location
< 1000' AGL	> 1000' AGL	< 1000' AGL	> 1000' AGL	
				Red obstacle is above or within 100 ft below the aircraft altitude
				Yellow obstacle is between 100 ft and 1000 ft below the aircraft altitude

Table 6-15 Terrain-SVS Obstacle Colors and Symbology

Potential Impact Point Symbol	Alert Type	Example Annunciation
	Warning	
	Caution	

Table 6-16 Terrain-SVS Potential Impact Point Symbols with Alert Types

Terrain-SVS information can be displayed on the following maps:

- PFD Inset Map
- Navigation Map Page
- Terrain-SVS Page
- Trip Planning Page
- Flight Plan Pages
- Video Page

Displaying terrain and obstacle information (maps other than the TERRAIN-SVS Page):

- 1) Press the **MAP** Softkey (for the PFD Inset Map, select the **INSET** Softkey).
- 2) Press the **TERRAIN** Softkey to display terrain and obstacle data.

When Terrain-SVS is selected on maps other than the Terrain-SVS Page, a terrain icon is shown to indicate the feature is enabled for display.

The Navigation Map Page Setup Menu provides a means in addition to the softkeys for enabling/disabling the display of terrain and obstacles. The setup menu also controls the map range settings above which terrain and obstacle data are decluttered from the display. If a map range larger than the map range setting is selected, the data is removed from the map. For terrain data, the enable/disable function applies only to the MFD, while the range setting also affects the PFD Inset Map.

Terrain data can be selected for display independently of obstacle data; however, obstacles for which warnings and cautions are issued are shown when terrain is selected for display and the map range is within the setting limit.

Maps besides the Terrain-SVS Page use settings based on those selected for the Navigation Map Page. The maximum display ranges for obstacles on each map are dependent on the range setting made for the Navigation Map. If the maximum range for obstacle display on the Navigation Map is adjusted to below 20 nm, the highest obstacle display range settings on the other applicable maps are also adjusted proportionally.



CAUTION: *Terrain and obstacle data will not be displayed when the Navigation Map range is larger than the MAP SETUP range setting for TERRAIN DATA and OBSTACLE DATA.*

Customizing terrain and obstacle display on the Navigation Map Page:

- 1) Select the Navigation Map Page.
- 2) Press the **MENU** Key.
- 3) With 'Map Setup' highlighted, press the **ENT** Key (Figure 6-127).
- 4) Turn the small **FMS** Knob to select the 'Map' Group and press the **ENT** Key (Figure 6-128).
- 5) Turn the large **FMS** Knob or press the **ENT** Key to scroll through product selections (Figure 6-129).
 - TERRAIN DATA – Turns the display of terrain data on or off and sets maximum range at which terrain is shown
 - OBSTACLE DATA – Turns the display of obstacle data on or off and sets maximum range at which obstacles are shown
- 6) Turn the small **FMS** Knob to scroll through options for each product (ON/OFF, range settings).
- 7) Press the **ENT** Key to select an option.
- 8) Press the **FMS** Knob or **CLR** Key to return to the Navigation Map Page with the changed settings.



Figure 6-127 Navigation Map Page Menu



Figure 6-128 Navigation Map Page Setup Menu

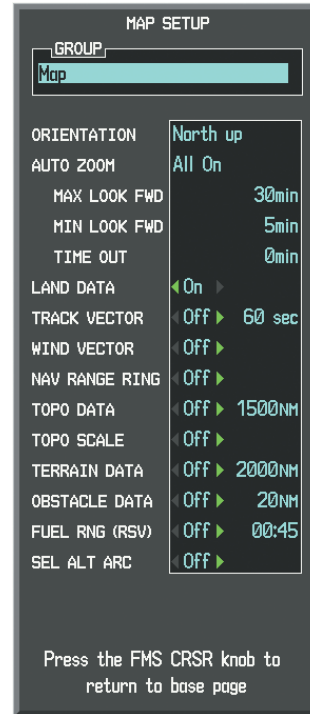

Figure 6-129 Navigation Map Page Setup Menu, Map Group

TERRAIN-SVS PAGE

The Terrain-SVS Page is specialized to show terrain, obstacle, and potential impact point data in relation to the aircraft's current altitude, without clutter from the basemap. Aviation data (airports, VORs, and other NAVAIDs) can be displayed for reference. If an obstacle and the projected flight path of the aircraft intersect, the display automatically zooms in to the closest potential point of impact on the Terrain-SVS Page.

Aircraft orientation on this map is always heading up unless there is no valid heading. Two views are available relative to the position of the aircraft: the 360° default display and the radar-like ARC (120°) display. Map range is adjustable with the **RANGE** Knob from 1 to 200 nm, as indicated by the map range rings (or arcs).

Displaying the Terrain-SVS Page:

- 1) Turn the large **FMS** Knob to select the Map Page Group.
- 2) Turn the small **FMS** Knob to select the TERRAIN-SVS Page.

Changing the Terrain-SVS Page view:

- 1) Press the **VIEW** Softkey.
- 2) Press the **360** or **ARC** Softkey to select the desired view.

Or:

- 1) Press the **MENU** Key.
- 2) Select 'View Arc' or 'View 360°' (choice dependent on current state) and press the **ENT** Key to change the view

Showing/hiding aviation information on the Terrain-SVS Page:

- 1) Press the **MENU** Key.
- 2) Select 'Show Aviation Data' or 'Hide Aviation Data' (choice dependent on current state) and press the **ENT** Key.

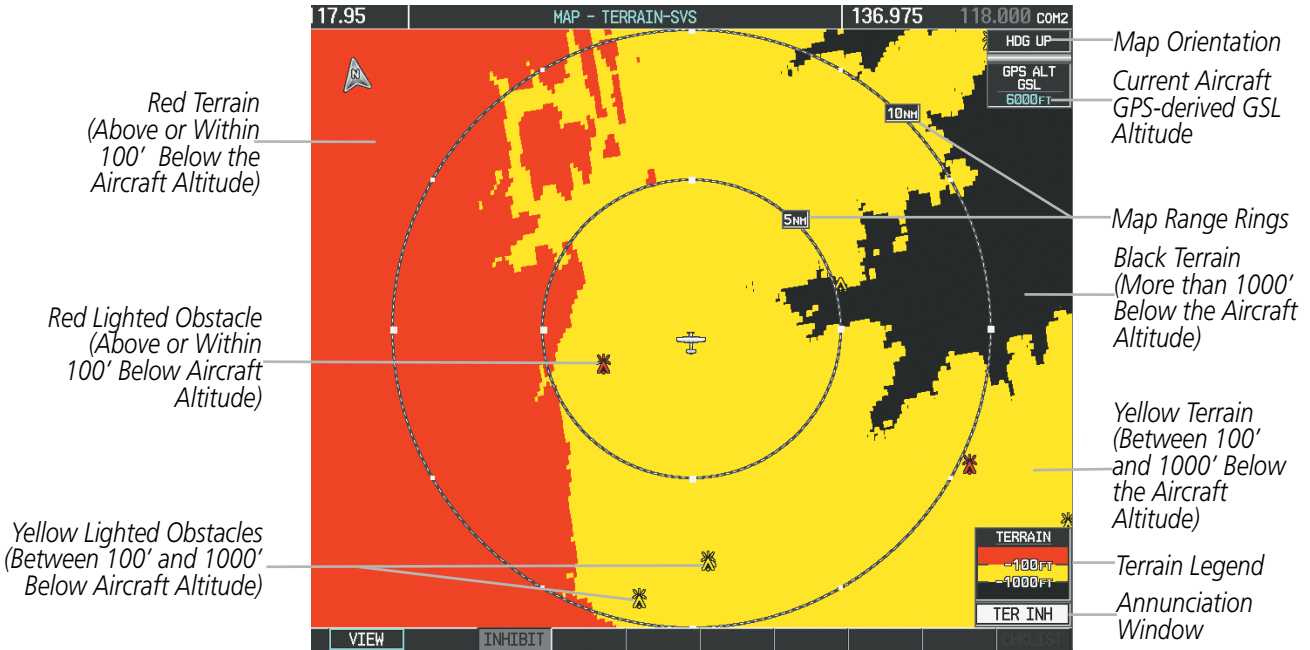

Figure 6-130 Terrain-SVS Page

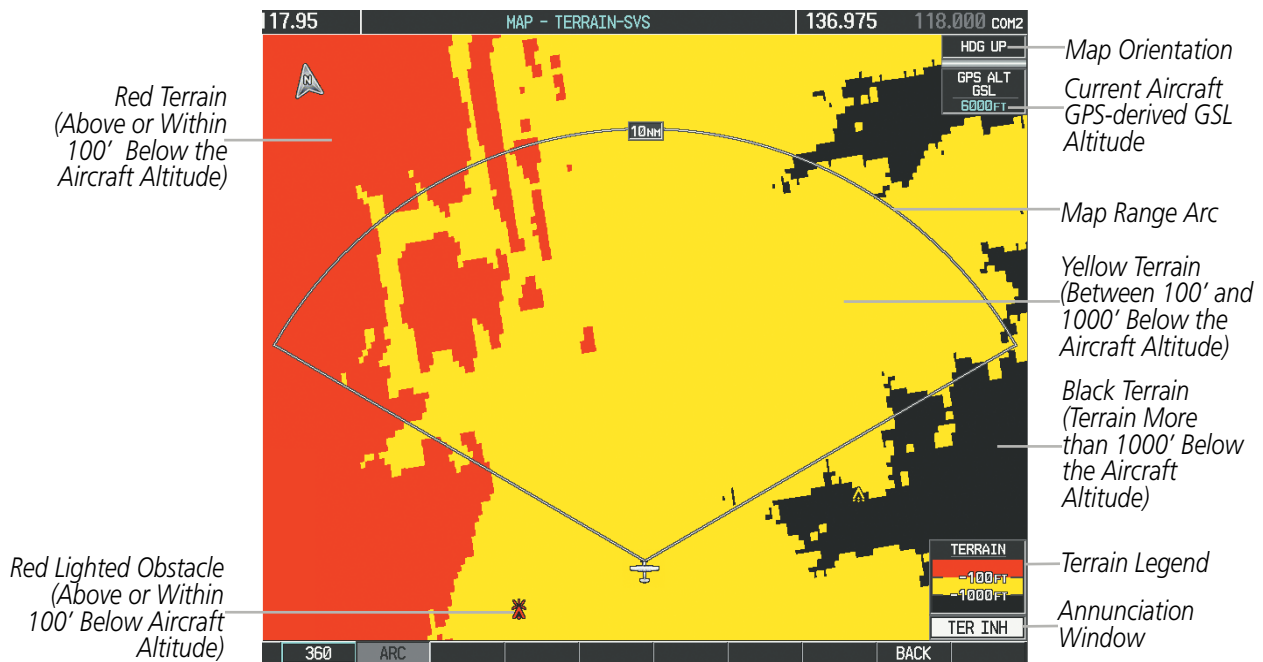

Figure 6-131 Terrain-SVS Page (ARC View)

TERRAIN-SVS ALERTS

Alerts are issued when flight conditions meet parameters that are set within Terrain-SVS software algorithms. Terrain-SVS alerts typically employ a CAUTION or a WARNING alert severity level, or both. When an alert is issued, visual annunciations are displayed and aural alerts are simultaneously issued. Table 6-17 shows Terrain-SVS alert types with corresponding annunciations and aural messages.

When an alert is issued, annunciations appear on the PFD and MFD. The Terrain-SVS Alert Annunciation is shown to the upper left of the Altimeter on the PFD and below the Terrain Legend on the MFD. If the Terrain-SVS Page is not displayed at the time, a pop-up alert appears on the MFD. To acknowledge the pop-up alert:

- Press the **CLR** Key (returns to the currently viewed page), or
- Press the **ENT** Key (accesses the Terrain-SVS Page)

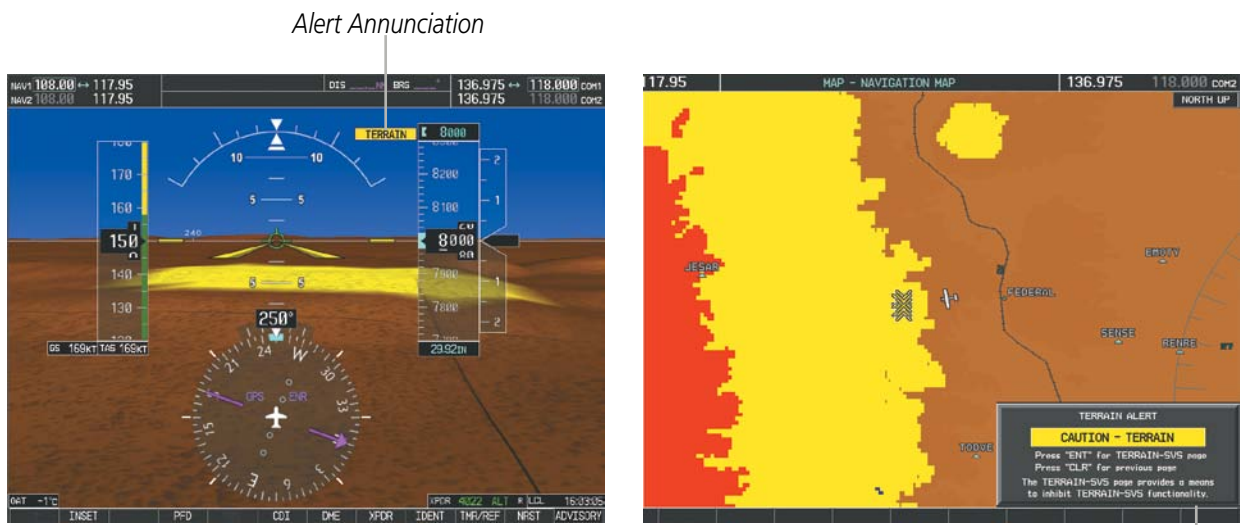

Figure 6-132 Terrain-SVS Alert Annunciations

Pop-up Alert

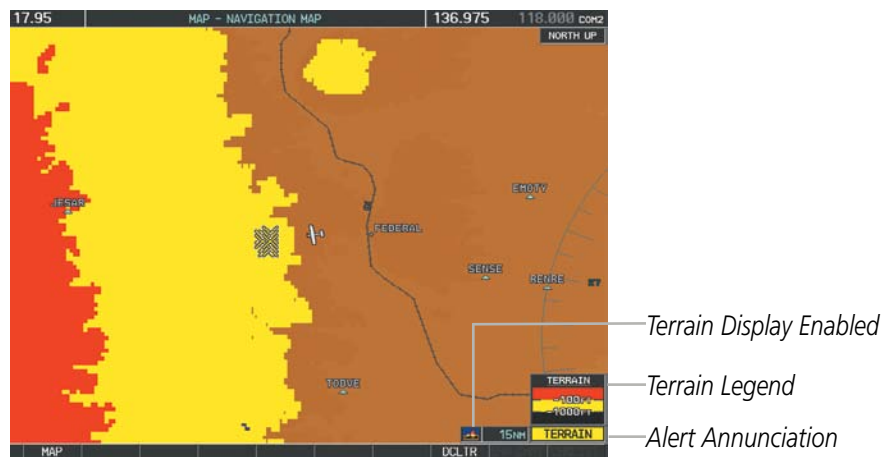

Figure 6-133 Navigation Map Page (After Terrain-SVS Pop-up Alert Acknowledgment)

Terrain Display Enabled
 Terrain Legend
 Alert Annunciation

Alert Type	PFD/MFD* Alert Annunciation	MFD Pop-Up Alert (except Terrain-SVS Page)	Aural Message
Reduced Required Terrain Clearance Warning (RTC)	TERRAIN	WARNING - TERRAIN	"Warning; Terrain, Terrain"
Imminent Terrain Impact Warning (ITI)	TERRAIN	WARNING - TERRAIN	"Warning; Terrain, Terrain"
Reduced Required Obstacle Clearance Warning (ROC)	TERRAIN	WARNING - OBSTACLE	"Warning; Obstacle, Obstacle"
Imminent Obstacle Impact Warning (IOI)	TERRAIN	WARNING - OBSTACLE	"Warning; Obstacle, Obstacle"
Reduced Required Terrain Clearance Caution (RTC)	TERRAIN	CAUTION - TERRAIN	"Caution; Terrain, Terrain"
Imminent Terrain Impact Caution (ITI)	TERRAIN	CAUTION - TERRAIN	"Caution; Terrain, Terrain"
Reduced Required Obstacle Clearance Caution (ROC)	TERRAIN	CAUTION - OBSTACLE	"Caution; Obstacle, Obstacle"
Imminent Obstacle Impact Caution (IOI)	TERRAIN	CAUTION - OBSTACLE	"Caution; Obstacle, Obstacle"

* Annunciation is displayed on the MFD when terrain display is enabled.

Table 6-17 Terrain-SVS Alerts Summary

FORWARD LOOKING TERRAIN AVOIDANCE

The Forward Looking Terrain Avoidance (FLTA) feature of Terrain-SVS compares the aircraft's projected flight path with known terrain and obstacles in their respective databases and issues four types of alerts as either a caution or a warning:

Reduced Required Terrain Clearance (RTC) and **Reduced Required Obstacle Clearance (ROC)** alerts are issued when the aircraft flight path is above terrain, yet is projected to come within the minimum clearance values in Figure 6-134. When an RTC alert is issued, a potential impact point is displayed on the Terrain-SVS Page.

Imminent Terrain Impact (ITI) and **Imminent Obstacle Impact (IOI)** alerts are issued when the aircraft is below the elevation of a terrain or obstacle cell in the aircraft's projected path. ITI and IOI alerts are accompanied by a potential impact point displayed on the Terrain-SVS Page. The alert is annunciated when the projected vertical flight path is calculated to come within minimum clearance altitudes in Figure 6-134.

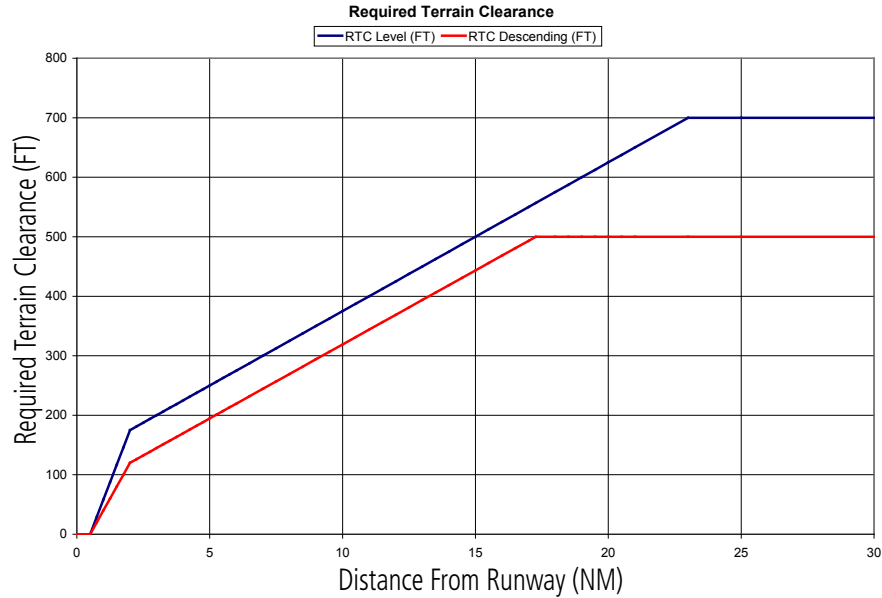

Figure 6-134 FLTA Alert Minimum Terrain and Obstacle Clearance Values

FLTA alerts are automatically inhibited when the aircraft is less than 200 feet above the destination runway elevation while within 0.5 nm of the approach runway or the aircraft is between runway ends. When Terrain-SVS alerts are inhibited, the annunciation ‘TER INH’ is shown on the PFD and in the MFD terrain annunciation window.

FLTA alerts may also be manually inhibited. Use discretion when inhibiting FLTA alerts, as they should be enabled where appropriate.

TER INH

Figure 6-135 Terrain-SVS Alerting Disabled (Terrain-SVS Inhibited) Annunciation

Inhibiting/enabling Terrain-SVS alerting:

- 1) Select the Terrain-SVS Page.
- 2) Press the **INHIBIT** Softkey to inhibit or enable Terrain-SVS (choice dependent on current state).

Or:

- 1) Select the Terrain-SVS Page.
- 2) Press the **MENU** Key.
- 3) Select ‘Inhibit Terrain-SVS’ or ‘Enable Terrain-SVS’ (choice dependent on current state) and press the **ENT** Key.

If Terrain-SVS alerts are inhibited when the Final Approach Fix is the active waypoint in a GPS SBAS approach, a ‘LOW ALT’ annunciation may appear on the PFD next to the Altimeter if the current aircraft altitude is at least 164 feet below the prescribed altitude at the Final Approach Fix. See the Flight Instruments Section for details.

SYSTEM STATUS

During power-up, Terrain-SVS conducts a self-test of its aural and visual annunciations. An aural alert is issued at test completion.

Terrain-SVS continually monitors several system-critical items such as database validity, hardware status, and GPS status. If the terrain/obstacle database is not available, the aural message **“Terrain System Failure”** is generated along with the ‘TER FAIL’ alert annunciation.

Terrain-SVS requires a 3-D GPS navigation solution along with specific vertical accuracy minimums. Should the navigation solution become degraded or if the aircraft is out of the database coverage area, the annunciation ‘TER N/A’ is generated in the annunciation window and on the Terrain-SVS Page. The aural message **“Terrain System Not Available”** is generated. When sufficient GPS signal is returns and the aircraft is within the database coverage area, the aural message **“Terrain System Available”** is generated.

Alert Type	PFD/MFD† Alert Annunciation	Terrain-SVS Page Center Banner Annunciation	Aural Message
System Test in Progress	TER TEST	TERRAIN TEST	None
System Test Pass	None	None	“Terrain System Test OK”
Terrain Alerting Inhibited	TER INH	None	None
No GPS position	TER N/A	NO GPS POSITION	“Terrain System Not Available”*
Excessively degraded GPS signal; or Out of database coverage area	TER N/A	None	“Terrain System Not Available”*
Terrain System Test Fail; Terrain or Obstacle database unavailable or invalid; Invalid software configuration; or System audio fault	TER FAIL	TERRAIN FAIL	“Terrain System Failure”
MFD Terrain or Obstacle database unavailable or invalid, and Terrain-SVS operating with PFD Terrain or Obstacle databases	None	TERRAIN DATABASE FAILURE	None

† Annunciation is shown on Terrain-SVS Page and the Navigation Map Page when Terrain is enabled.

* “Terrain System Available” will be heard when sufficient GPS signal is received, or Terrain database coverage area re-entered.

Table 6-18 Terrain-SVS System Status Annunciations

6.8 TAWS-B



WARNING: Do not use TAWS information for primary terrain avoidance. TAWS is intended only to enhance situational awareness.



NOTE: Terrain data is not displayed when the aircraft is outside of the installed terrain database coverage area.



NOTE: The data contained in the TAWS databases comes from government agencies. Garmin accurately processes and cross-validates the data but cannot guarantee the accuracy and completeness of the data.

TAWS-B (Terrain Awareness and Warning System - Class B) is used to increase situational awareness and aid in reducing controlled flight into terrain (CFIT). TAWS provides visual and aural annunciations when terrain and obstacles are within the given altitude threshold from the aircraft. The displayed alerts and warnings are advisory in nature only.

TAWS-B satisfies TSO-C151b Class B requirements for certification.

TAWS-B requires the following to operate properly:

- A valid terrain/obstacle/airport terrain database
- A valid 3-D GPS position solution

TAWS-B uses terrain and obstacle information supplied by government sources. Terrain information is based on terrain elevation information in a database that may contain inaccuracies. Individual obstructions may be shown if available in the database. The data undergoes verification by Garmin to confirm accuracy of the content, per TSO-C151b. However, the displayed information should never be understood as being all-inclusive and data may be inaccurate.

TAWS-B uses information provided from the GPS receiver to provide a horizontal position and altitude. GPS altitude is derived from satellite measurements. GPS altitude is then converted to the height above geodetic sea level (GSL), which is the height above mean sea level (MSL) calculated geometrically. GSL altitude is used to determine TAWS-B alerts. GSL altitude accuracy is affected by satellite geometry, but is not subject to variations in pressure and temperature that normally affect pressure altitude sensors. GSL altitude does not require local altimeter settings to determine MSL altitude. It is a widely-used MSL altitude source. Therefore, GSL altitude provides a highly accurate and reliable MSL altitude source to calculate terrain and obstacle alerts.

The terrain and obstacle databases used by TAWS-B are referenced to MSL. Using the GPS position and GSL altitude, TAWS-B displays a 2-D picture of the surrounding terrain and obstacles relative to the position and altitude of the aircraft. Furthermore, the GPS position and GSL altitude are used to calculate and “predict” the aircraft’s flight path in relation to the surrounding terrain and obstacles. In this manner, TAWS-B can provide advanced alerts of predicted dangerous terrain conditions.

Baro-corrected altitude (or indicated altitude) is derived by adjusting the altimeter setting for local atmospheric conditions. The most accurate baro-corrected altitude can be achieved by frequently updating the altimeter setting to the nearest reporting station along the flight path. However, because actual atmospheric conditions seldom match the standard conditions defined by the International Standard Atmosphere (ISA) model (where

pressure, temperature, and lapse rates have fixed values), it is common for the baro-corrected altitude (as read from the altimeter) to differ from the GSL altitude. This variation results in the aircraft's GSL altitude differing from the baro-corrected altitude.

DISPLAYING TAWS-B DATA

TAWS-B uses yellow (caution) and red (warning) to depict terrain and obstacles (with heights greater than 200 feet above ground level, AGL) alerts relative to aircraft altitude. Colors are adjusted automatically as the aircraft altitude changes. The colors and symbols in the figure and tables below are used to represent terrain, obstacles, and potential impact points.

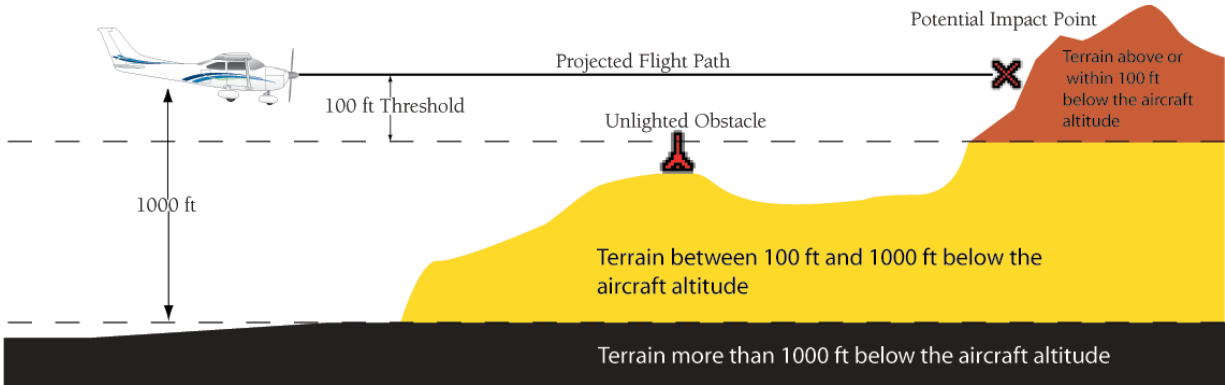

Figure 6-136 Terrain Altitude/Color Correlation for TAWS

Unlighted Obstacle		Lighted Obstacle		Obstacle Location
< 1000' AGL	> 1000' AGL	< 1000' AGL	> 1000' AGL	
				Red obstacle is above or within 100 ft below the aircraft altitude
				Yellow obstacle is between 100 ft and 1000 ft below the aircraft altitude

Table 6-19 TAWS-B Obstacle Colors and Symbology

Potential Impact Point Symbol	Alert Type	Example Annunciation
	Warning	
	Caution	

Table 6-20 TAWS-B Potential Impact Point Symbols with Alert Types

TAWS-B information can be displayed on the following maps:

- PFD Inset Map
- Navigation Map Page
- TAWS-B Page
- Trip Planning Page
- Flight Plan Pages
- Video Pages

Displaying terrain and obstacle information (maps other than the TAWS-B Page):

- 1) Press the **MAP** Softkey (for the PFD Inset Map, press the **INSET** Softkey).
- 2) Press the **TERRAIN** Softkey to display terrain and obstacle data.

When TAWS-B is selected on maps other than the TAWS-B Page, an icon is shown to indicate that the feature is enabled for display. A legend for TAWS-B terrain colors will accompany the icon on the Navigation Map Page (Figure 6-137) and the Flight Plan Pages. The icon is always shown on the TAWS-B Page.

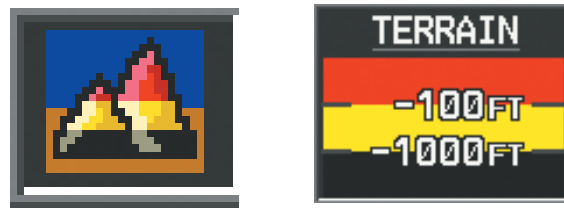

Figure 6-137 TAWS-B Icon and Legend

The Navigation Map Page Setup Menu provides a means in addition to the softkeys for enabling/disabling the display of terrain and obstacles. The setup menu also controls the map range settings above which terrain and obstacle data are decluttered from the display. If a map range larger than the map range setting is selected, the data is removed from the map. For terrain data, the enable/disable function applies only to the MFD, while the range setting also affects the PFD Inset Map.

Terrain data can be selected for display independently of obstacle data; however, obstacles for which warnings and cautions are issued are shown when terrain is selected for display and the map range is within the setting limit.

Maps besides the TAWS-B Page use settings based on those selected for the Navigation Map Page. The maximum display ranges for obstacles on each map are dependent on the range setting made for the Navigation Map. If the maximum range for obstacle display on the Navigation Map is adjusted to below 20 nm, the highest obstacle display range settings on the other applicable maps are also adjusted proportionally.



CAUTION: Terrain and obstacle data will not be displayed when the Navigation Map range is larger than the MAP SETUP range setting for TERRAIN DATA and OBSTACLE DATA.

Customizing terrain and obstacle display on the Navigation Map Page:

- 1) Select the Navigation Map Page.
- 2) Press the **MENU** Key.
- 3) With 'Map Setup' highlighted, press the **ENT** Key (Figure 6-138).
- 4) Turn the small **FMS** Knob to select the 'Map' Group and press the **ENT** Key (Figure 6-139).
- 5) Turn the large **FMS** Knob or press the **ENT** Key to scroll through product selections (Figure 6-140).
 - TERRAIN DATA – Turns the display of terrain data on or off and sets maximum range at which terrain is shown
 - OBSTACLE DATA – Turns the display of obstacle data on or off and sets maximum range at which obstacles are shown
- 6) Turn the small **FMS** Knob to scroll through options for each product (ON/OFF, range settings).
- 7) Press the **ENT** Key to select an option.
- 8) Press the **FMS** Knob or **CLR** Key to return to the Navigation Map Page with the changed settings.

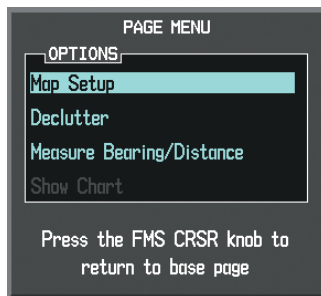

Figure 6-138 Navigation Map Page Menu

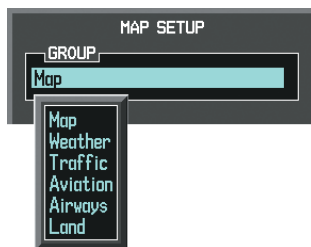

Figure 6-139 Navigation Map Page Setup Menu

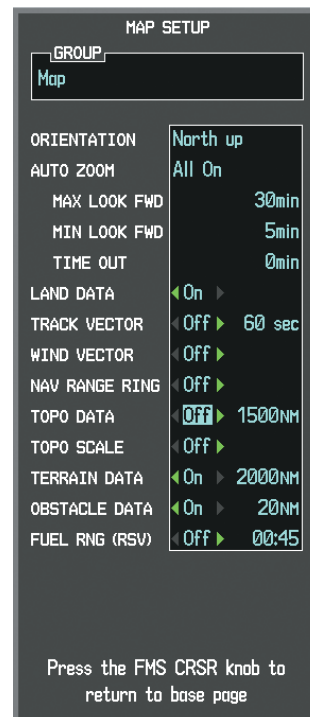

Figure 6-140 Navigation Map Page Setup Menu, Map Group

TAWS-B PAGE

The TAWS-B Page is specialized to show terrain, obstacle, and potential impact point data in relation to the aircraft's current altitude, without clutter from the basemap. It is the principal map page for viewing TAWS-B information. Aviation data (airports, VORs, and other NAVAIDs) can be displayed for reference. If an obstacle and the projected flight path of the aircraft intersect, the display automatically zooms in to the closest potential point of impact on the TAWS-B Page.

Aircraft orientation on this map is always heading up unless there is no valid heading. Two views are available relative to the position of the aircraft: the 360° default display and the radar-like ARC (120°) display. Map range is adjustable with the **RANGE** Knob from 1 to 200 nm, as indicated by the map range rings (or arcs).

Displaying the TAWS-B Page:

- 1) Turn the large **FMS** Knob to select the Map Page Group.
- 2) Turn the small **FMS** Knob to select TAWS-B Page.

Changing the TAWS-B Page view:

- 1) Press the **VIEW** Softkey.
- 2) Press the **360** or **ARC** Softkey to select the desired view.

Or:

- 1) Press the **MENU** Key.
- 2) Select 'View Arc' or 'View 360' (choice dependent on current state) and press the **ENT** Key to change the view

Showing/hiding aviation information on the TAWS-B Page:

- 1) Press the **MENU** Key.
- 2) Select 'Show Aviation Data' or 'Hide Aviation Data' (choice dependent on current state) and press the **ENT** Key.

- SYSTEM OVERVIEW
- FLIGHT INSTRUMENTS
- EIS
- AUDIO PANEL & CNS
- FLIGHT MANAGEMENT
- HAZARD AVOIDANCE
- AFCS
- ADDITIONAL FEATURES
- APPENDICES
- INDEX

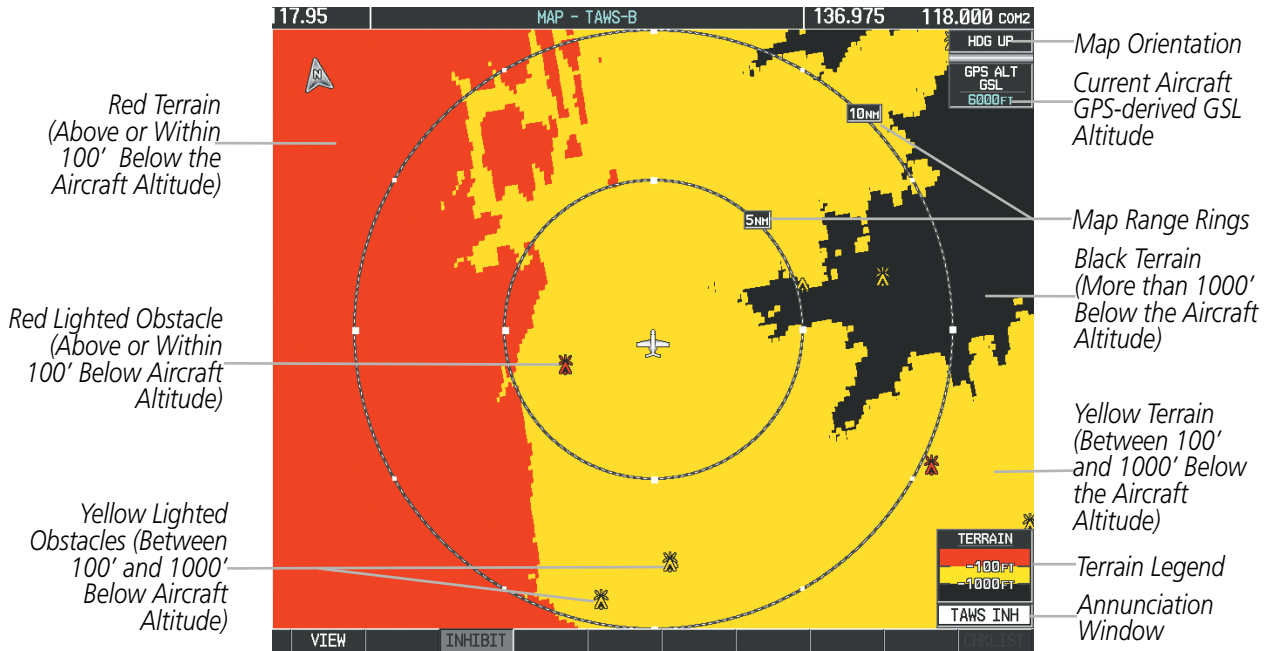

Figure 6-141 TAWS-B Page

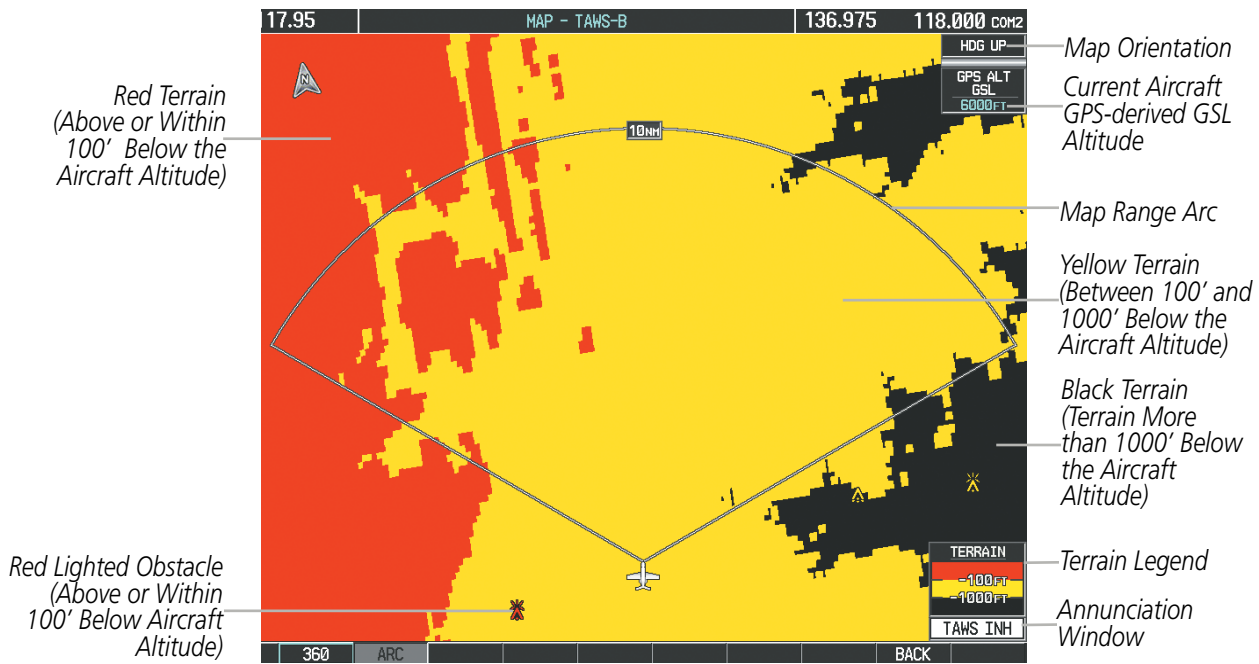

Figure 6-142 TAWS-B Page (ARC View)

TAWS-B ALERTS

Alerts are issued when flight conditions meet parameters that are set within TAWS-B software algorithms. TAWS-B alerts typically employ a CAUTION or a WARNING alert severity level, or both. When an alert is issued, visual annunciations are displayed and aural alerts are simultaneously issued. Table 6-21 shows TAWS-B alert types with corresponding annunciations and aural messages.

When an alert is issued, annunciations appear on the PFD and MFD. The TAWS-B Alert Annunciation is shown to the upper left of the Altimeter on the PFD and below the Terrain Legend on the MFD. If the TAWS-B Page is not displayed at the time, a pop-up alert appears on the MFD. To acknowledge the pop-up alert:

- Press the **CLR** Key (returns to the currently viewed page), or
- Press the **ENT** Key (accesses the TAWS-B Page)



Figure 6-143 TAWS-B PFD Alert Annunciation

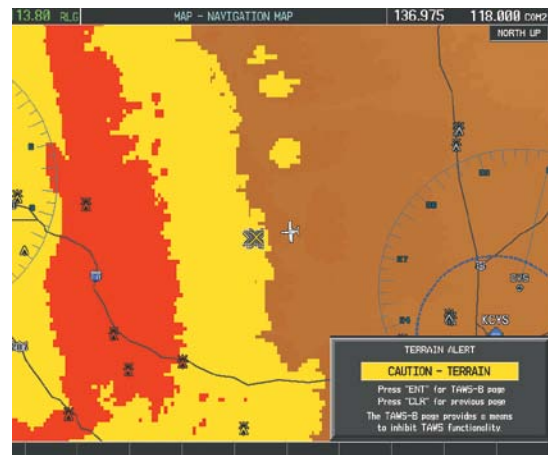

Figure 6-144 Navigation Map Page TAWS-B Pop-up Alert

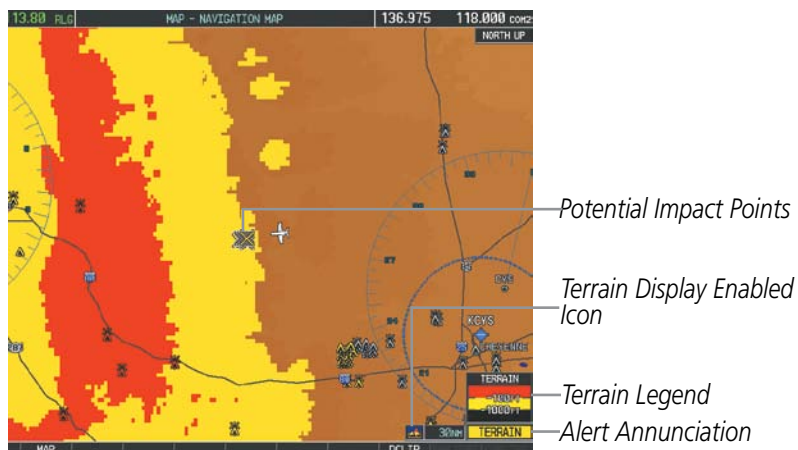

Figure 6-145 Navigation Map Page (After TAWS-B Pop-up Alert Acknowledgment)

- SYSTEM OVERVIEW
- FLIGHT INSTRUMENTS
- EIS
- AUDIO PANEL & CNS
- FLIGHT MANAGEMENT
- HAZARD AVOIDANCE
- AFCS
- ADDITIONAL FEATURES
- APPENDICES
- INDEX

Alert Type	PFD/MFD** Alert Annunciation	MFD Pop-Up Alert (except TAWS-B Page)	Aural Message
Excessive Descent Rate Warning (EDR)	PULL UP	PULL-UP	"Pull Up"
Reduced Required Terrain Clearance Warning (RTC)	PULL UP	TERRAIN - PULL-UP * or TERRAIN AHEAD - PULL-UP	"Terrain, Terrain; Pull Up, Pull Up" * or "Terrain Ahead, Pull Up; Terrain Ahead, Pull Up" *
Imminent Terrain Impact Warning (ITI)	PULL UP	TERRAIN - PULL-UP or TERRAIN AHEAD - PULL-UP *	"Terrain, Terrain; Pull Up, Pull Up" or "Terrain Ahead, Pull Up; Terrain Ahead, Pull Up" *
Reduced Required Obstacle Clearance Warning (ROC)	PULL UP	OBSTACLE - PULL-UP * or OBSTACLE AHEAD - PULL-UP	"Obstacle, Obstacle; Pull Up, Pull Up" * or "Obstacle Ahead, Pull Up; Obstacle Ahead, Pull Up"
Imminent Obstacle Impact Warning (IOI)	PULL UP	OBSTACLE - PULL-UP or OBSTACLE AHEAD - PULL-UP *	"Obstacle, Obstacle; Pull Up, Pull Up" or "Obstacle Ahead, Pull Up; Obstacle Ahead, Pull Up" *
Reduced Required Terrain Clearance Caution (RTC)	TERRAIN	CAUTION - TERRAIN * or TERRAIN AHEAD	"Caution, Terrain; Caution, Terrain" * or "Terrain Ahead; Terrain Ahead"
Imminent Terrain Impact Caution (ITI)	TERRAIN	CAUTION - TERRAIN or TERRAIN AHEAD *	"Caution, Terrain; Caution, Terrain" or "Terrain Ahead; Terrain Ahead" *
Reduced Required Obstacle Clearance Caution (ROC)	TERRAIN	CAUTION - OBSTACLE or OBSTACLE AHEAD *	"Caution, Obstacle; Caution, Obstacle" or "Obstacle Ahead; Obstacle Ahead" *
Imminent Obstacle Impact Caution (IOI)	TERRAIN	CAUTION - OBSTACLE or OBSTACLE AHEAD	"Caution, Obstacle; Caution, Obstacle" * or "Obstacle Ahead; Obstacle Ahead"
Premature Descent Alert Caution (PDA)	TERRAIN	TOO LOW - TERRAIN	"Too Low, Terrain"
Altitude Callout "500"	None	None	"Five-Hundred"
Excessive Descent Rate Caution (EDR)	TERRAIN	SINK RATE	"Sink Rate"
Negative Climb Rate Caution (NCR)	TERRAIN	DON'T SINK * or TOO LOW - TERRAIN	"Don't Sink" * or "Too Low, Terrain"

* Alerts with multiple messages are configurable at installation and are installation-dependent. Alerts for the default configuration when more than one option is available are indicated with asterisks.

** Annunciation is displayed on the MFD when terrain display is enabled.

Table 6-21 TAWS-B Alerts Summary

EXCESSIVE DESCENT RATE ALERT

The purpose of the **Excessive Descent Rate (EDR)** alert is to provide suitable notification when the aircraft is determined to be closing (descending) upon terrain at an excessive speed. Figure 6-146 shows the parameters for the alert as defined by TSO-C151b.

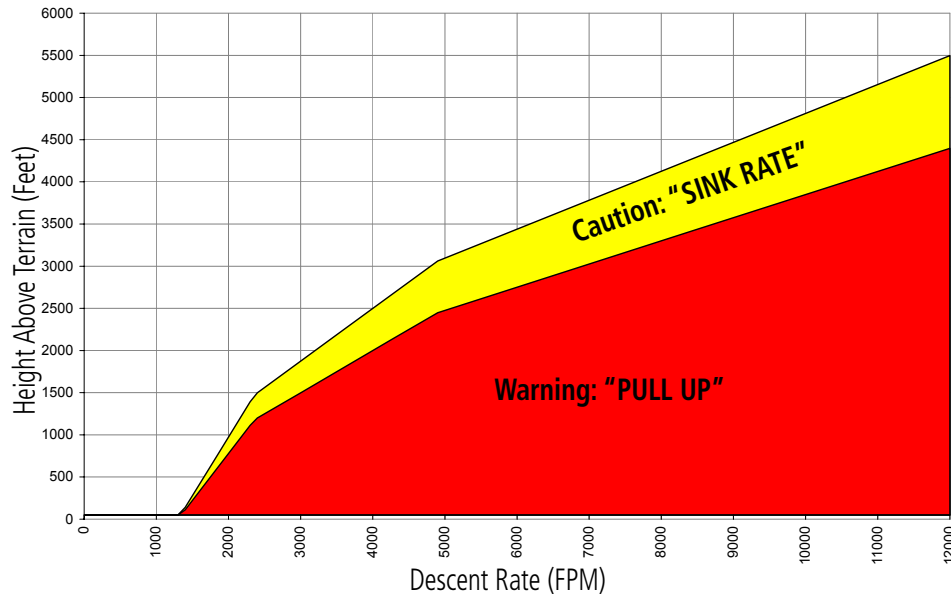

Figure 6-146 Excessive Descent Rate Alert Criteria

FORWARD LOOKING TERRAIN AVOIDANCE

The Forward Looking Terrain Avoidance (FLTA) feature of TAWS-B compares the aircraft's projected flight path with known terrain and obstacles in their respective databases and issues four types of alerts as either a caution or a warning:

Reduced Required Terrain Clearance (RTC) and **Reduced Required Obstacle Clearance (ROC)** alerts are issued when the aircraft flight path is above terrain, yet is projected to come within the minimum clearance values in Figure 6-147. When an RTC alert is issued, a potential impact point is displayed on the TAWS-B Page.

Imminent Terrain Impact (ITI) and **Imminent Obstacle Impact (IOI)** alerts are issued when the aircraft is below the elevation of a terrain or obstacle cell in the aircraft's projected path. ITI and IOI alerts are accompanied by a potential impact point displayed on the TAWS-B Page. The alert is annunciated when the projected vertical flight path is calculated to come within minimum clearance altitudes in Figure 6-147.

- SYSTEM OVERVIEW
- FLIGHT INSTRUMENTS
- EIS
- AUDIO PANEL & CNS
- FLIGHT MANAGEMENT
- HAZARD AVOIDANCE
- AFCS
- ADDITIONAL FEATURES
- APPENDICES
- INDEX

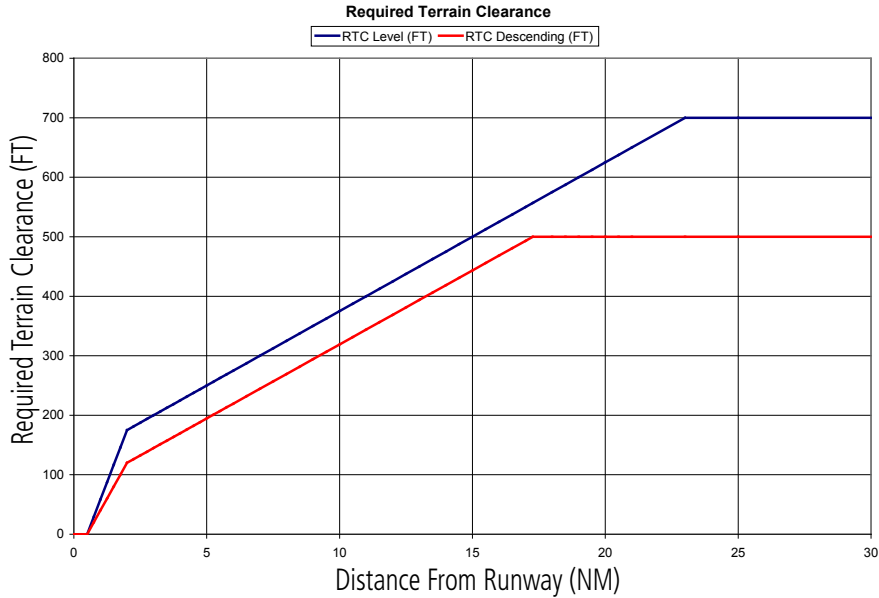

Figure 6-147 FLTA Alert Minimum Terrain and Obstacle Clearance Values

FLTA alerts are automatically inhibited when the aircraft is less than 200 feet above the destination runway elevation while within 0.5 nm of the approach runway or the aircraft is between runway ends.

PREMATURE DESCENT ALERTING

A **Premature Descent Alert (PDA)** is issued when the system detects that the aircraft is significantly below the normal approach path to a runway (Figure 6-148).

PDA alerting begins when the aircraft is below 700 feet AGL within 15 nm of the destination airport and ends when the aircraft is 0.5 nm from the runway threshold.

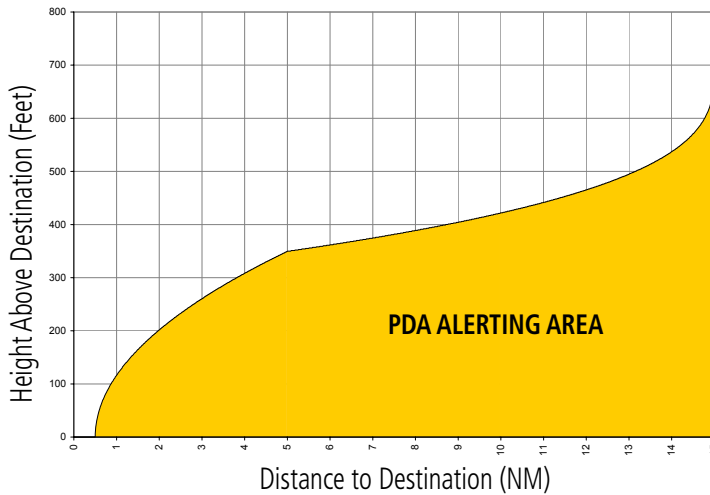

Figure 6-148 PDA Alerting Threshold

PDA and FLTA aural and visual alerts can be manually inhibited. Discretion should be used when inhibiting TAWS-B and the system should be enabled when appropriate. When TAWS-B is inhibited, the alert annunciation ‘TAWS INH’ is shown on the PFD and MFD (Figure 6-149).



Figure 6-149 TAWS-B Alerting Disabled (TAWS-B Inhibited) Annunciation

Inhibiting/enabling TAWS-B alerting:

- 1) Select the TAWS-B Page.
 - 2) Press the **INHIBIT** Softkey to inhibit or enable TAWS (choice dependent on current state).
- Or:**
- a) Press the **MENU** Key.
 - b) Select ‘Inhibit TAWS’ or ‘Enable TAWS’ (choice dependent on current state) and press the **ENT** Key.

If TAWS-B alerts are inhibited when the Final Approach Fix is the active waypoint in a GPS SBAS approach, a ‘LOW ALT’ annunciation may appear on the PFD next to the Altimeter if the current aircraft altitude is at least 164 feet below the prescribed altitude at the Final Approach Fix. See the Flight Instruments Section for details.

FIVE-HUNDRED AURAL ALERT

The purpose of the aural alert message “*Five-hundred*” is to provide an advisory alert of when the aircraft descends to within 500 feet above the terrain or runway threshold. When the aircraft is within 5 nm of an airport, the “*Five Hundred*” aural alert is based on the nearest runway threshold elevation. When the aircraft is more than 5 nm of the nearest airport, the “*Five Hundred*” aural alert is based on the height above terrain (as determined by the GPS altitude and Terrain Database).

There are no display annunciations or pop-up alerts that accompany the aural message

NEGATIVE CLIMB RATE AFTER TAKEOFF ALERT (NCR)

The **Negative Climb Rate (NCR) After Takeoff** alert (also referred to as “Altitude Loss After Takeoff”) provides alerts when the system determines the aircraft is losing altitude (closing upon terrain) after takeoff. The aural message “Don’t Sink” is given for NCR alerts, accompanied by an annunciation and a pop-up terrain alert on the display. NCR alerting is only active when departing from an airport and when the following conditions are met:

- Height above the terrain is less than 700 feet
- Distance from the departure airport is 2 nm or less
- Heading change from the departure heading is less than 110 degrees

Figures 6-81 and 6-82 shows the NCR alerting parameters as defined by TSO-C151b.

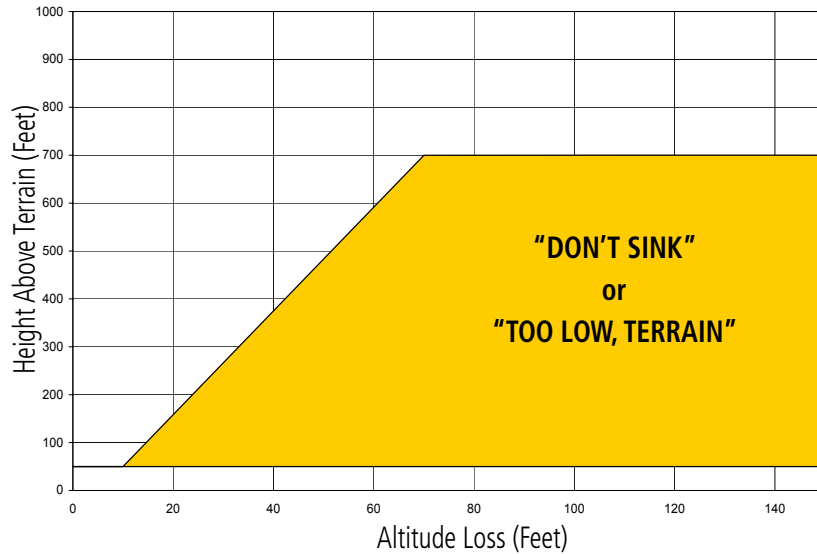

Figure 6-150 Negative Climb Rate (NCR) Altitude Loss

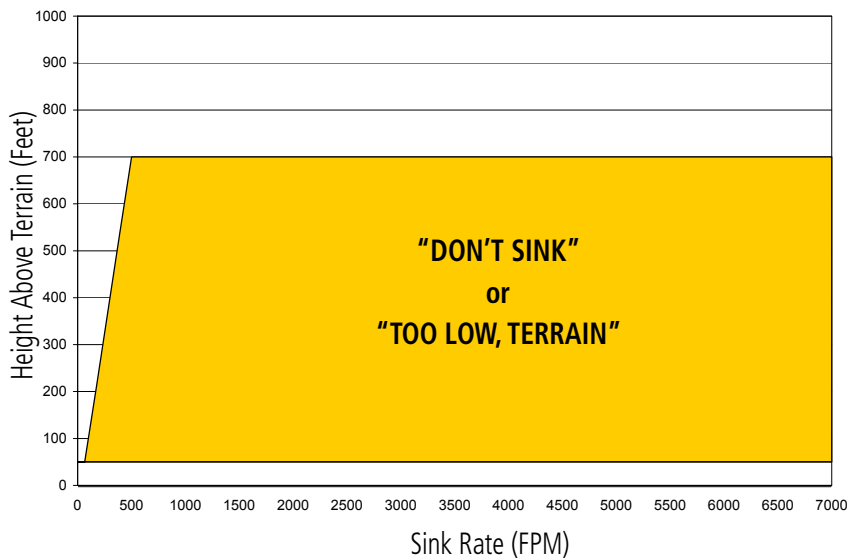

Figure 6-151 Negative Climb Rate (NCR) Sink Rate

SYSTEM STATUS

During power-up, TAWS-B conducts a self-test of its aural and visual annunciations. The system test can also be manually initiated. An aural message is issued at test completion. TAWS-B System Testing is disabled when ground speed exceeds 30 knots.

Manually testing the TAWS-B System:

- 1) Select the TAWS-B Page.
- 2) Press the **MENU** Key (Figure 6-152).
- 3) Select 'Test TAWS System' and press the **ENT** Key to confirm the selection.

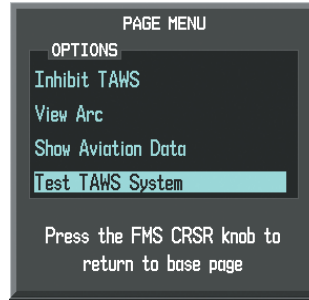

Figure 6-152 TAWS-B Page Menu

TAWS-B continually monitors several system-critical items such as database validity, hardware status, and GPS status. If the terrain/obstacle database is not available, the aural message “**TAWS System Failure**” is generated along with the ‘TAWS FAIL’ alert annunciation.

TAWS-B requires a 3-D GPS navigation solution along with specific vertical accuracy minimums. Should the navigation solution become degraded or if the aircraft is out of the database coverage area, the annunciation ‘TAWS N/A’ is generated in the annunciation window and on the TAWS-B Page. The aural message “**TAWS Not Available**” is generated.

Alert Type	PFD/MFD* Alert Annunciation	TAWS-B Page Center Banner Annunciation	Aural Message
System Test in progress	TAWS TEST	TAWS TEST	None
System Test pass	None	None	“TAWS System Test Test OK”
TAWS-B FLTA Alerting Inhibited	TAWS INH	None	None
No GPS position	TAWS N/A	NO GPS POSITION	“TAWS Not Available”
Excessively degraded GPS signal; or Out of database coverage area	TAWS N/A	None	“TAWS Not Available”
TAWS-B System Test Fail; Terrain or Obstacle database unavailable or invalid; Invalid software configuration; or System audio fault	TAWS FAIL	TAWS FAIL	“TAWS System Failure”
MFD Terrain or Obstacle database unavailable or invalid, and TAWS operating with PFD Terrain or Obstacle databases.	None	TERRAIN DATABASE FAILURE	None

† Annunciation is shown on TAWS-B Page and the Navigation Map Page when Terrain is enabled.

* “TAWS Available” will be heard when sufficient GPS signal is received, or Terrain database coverage area re-entered.

Table 6-22 TAWS-B System Status Annunciations

6.9 TRAFFIC INFORMATION SERVICE (TIS)



WARNING: The Traffic Information Service (TIS) is intended for advisory use only. TIS is intended to help the pilot locate traffic visually. It is the responsibility of the pilot to see and maneuver to avoid traffic.



NOTE: TIS is available only when the aircraft is within the service volume of a TIS-capable terminal radar site. Aircraft without an operating transponder are invisible to both Traffic Advisory Systems (TAS) and TIS. Aircraft without altitude reporting capability are shown without altitude separation data or climb descent indication.



NOTE: TIS is disabled if a Traffic Advisory System (TAS) is installed.

Traffic Information Service (TIS) is designed to help in detection and avoidance of other aircraft. TIS uses the Mode S transponder for the traffic data link. TIS receives traffic information from ground stations, and is updated every 5 seconds. The G1000 displays up to eight traffic targets within a 7.5-nm radius, from 3000 feet below to 3500 feet above the requesting aircraft. Traffic is displayed using the symbology shown in Table 6-23.



TIS Symbol	Description
	Non-Threat Traffic
	Traffic Advisory (TA)
	Traffic Advisory Off Scale

Table 6-23 TIS Traffic Symbols

Traffic Advisories (TA) alert the crew to intruding aircraft. When traffic meets the advisory criteria for the TA, a solid yellow circle symbol is generated. A TA which is detected but is outside the range of the map on which traffic is displayed are indicated with a message in the lower left corner of the map.

TIS also provides a vector line showing the direction in which the traffic is moving, to the nearest 45°. Traffic information for which TIS is unable to determine the bearing (non-bearing traffic) is displayed in the center of the Traffic Map Page (Figure 6-157) or in a banner at the lower left corner of maps other than the Traffic Map Page on which traffic can be displayed.

The altitude difference between the requesting aircraft and other intruder aircraft is displayed above/below the traffic symbol in hundreds of feet. If the other aircraft is above the requesting aircraft, the altitude separation appears above the traffic symbol; if below, the altitude separation appears below. Altitude trend is displayed as an up/down arrow (for speeds greater than 500 fpm in either direction) to the right of the target symbol. Traffic symbols for aircraft without altitude reporting capability appear without altitude separation or climb/descent information.

DISPLAYING TRAFFIC DATA

The Map - Traffic Map Page is the principal page for viewing traffic information. Additional displays of traffic information are available as map overlays while TIS is operating, and serve as additional reference to the Traffic Map Page. Traffic information can be displayed on the following maps and pages:

- PFD Inset Map
- Navigation Map Page
- Traffic Map Page
- Trip Planning Page
- Nearest Pages
- Active Flight Plan Page
- Video Page

Traffic information is also displayed on the PFD when the Synthetic Vision System (SVS) option is installed and enabled. See the Additional Features Section for details.

Displaying traffic information (maps other than the Traffic Map Page):

- 1) Press the **MAP** Softkey.
- 2) Press the **TRAFFIC** Softkey. Traffic is now displayed on the map.

When traffic is selected on maps other than the Traffic Map Page, an icon is shown to indicate the feature is enabled for display.



Figure 6-153 TIS Traffic on Navigation Map Page

Displaying traffic information (PFD Inset Map):

- 1) Select the **INSET** Softkey.
- 2) Select the **TRAFFIC** Softkey to display traffic data on the inset map (TRFC-1).
- 3) Select the softkey again to display the traffic-only inset (TRFC-2).
- 4) Select the softkey again to remove traffic data.

The Navigation Map Page Setup Menu provides a means in addition to the softkey for enabling/disabling display of traffic. The setup menu also controls the map range settings above which traffic data (symbols and labels) are decluttered from the display. If a map range larger than the map range setting is selected, the data is removed from the map. Maps besides the Traffic Map Page use settings based on those selected for the Navigation Map Page.

Customizing traffic display on the Navigation Map Page:

- 1) Select the Navigation Map Page.
- 2) Press the **MENU** Key.
- 3) With 'Map Setup' highlighted, press the **ENT** Key (Figure 6-154).
- 4) Turn the small **FMS** Knob to select the 'Traffic' Group and press the **ENT** Key (Figure 6-155).
- 5) Turn the large **FMS** Knob or press the **ENT** Key to scroll through product selections (Figure 6-156).
 - TRAFFIC – Turns the display of traffic data on or off
 - TRAFFIC MODE – Selects the traffic mode for display; select from:
 - All Traffic - Displays all traffic
 - TA ONLY - Displays Traffic Alerts only
 - TRAFFIC SMBL – Selects the maximum range at which traffic symbols are shown
 - TRAFFIC LBL – Selects the maximum range at which traffic labels are shown (with the option to turn off)
- 6) Turn the small **FMS** Knob to scroll through options for each product (ON/OFF, range settings, etc.).
- 7) Press the **ENT** Key to select an option.
- 8) Press the **FMS** Knob or **CLR** Key to return to the Navigation Map Page with the changed settings.

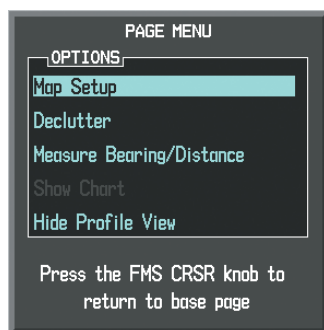

Figure 6-154 Navigation Map Page Menu

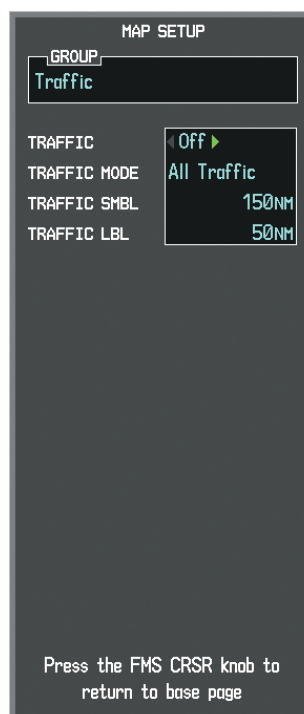

Figure 6-156 Navigation Map Page Setup Menu, Traffic Group



Figure 6-155 Navigation Map Page Setup Menu

TRAFFIC MAP PAGE

The Traffic Map Page is the principal map page for viewing TIS traffic data in relation to the aircraft's current position and altitude, without clutter from the basemap. Aircraft orientation on this map is always heading up unless there is no valid heading. Map range is adjustable with the **RANGE** Knob from 2 to 12 nm, as indicated by the map range rings.

The traffic mode is annunciated in the upper left corner of the Traffic Map Page. When the aircraft is on the ground, TIS automatically enters Standby Mode. Once the aircraft is airborne, TIS switches from Standby to Operating Mode and the system begins to display traffic information. Refer to the System Status discussion for more information.

Displaying traffic on the Traffic Map Page:

- 1) Turn the large **FMS** Knob to select the Map Page Group.
- 2) Turn the small **FMS** Knob to select the Traffic Map Page.
- 3) Confirm TIS is in Operating Mode:

Press the **OPERATE** Softkey to begin displaying traffic.

Or:

- a) Press the **MENU** Key.
- b) Select 'Operate Mode' (shown if TIS is in Standby Mode) and press the **ENT** Key.

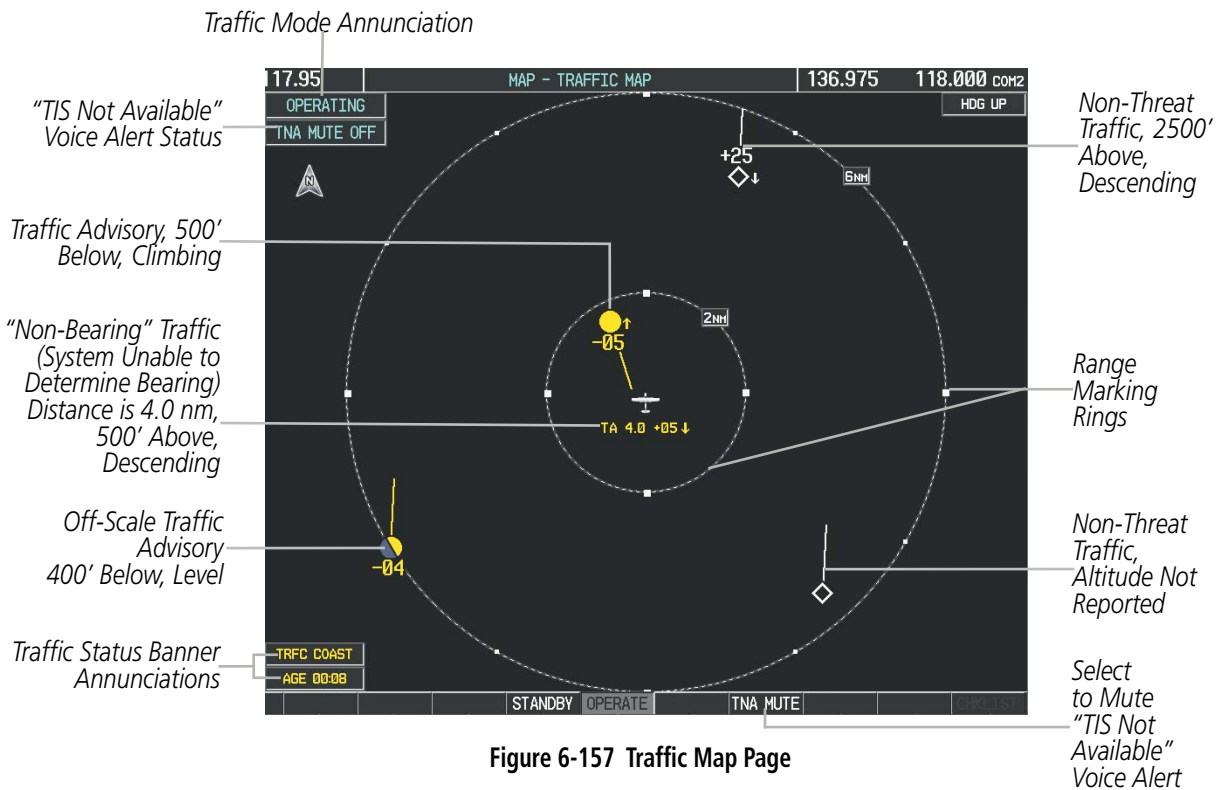

Figure 6-157 Traffic Map Page

TIS ALERTS

When the number of TAs on the Traffic Map Page increases from one scan to the next, the following occur:

- A single **“Traffic”** voice alert is generated.
- A ‘TRAFFIC’ Annunciation appears to the top left of the Attitude Indicator on the PFD, flashing for 5 seconds and remaining displayed until no TAs are detected in the area.
- The PFD Inset Map is automatically displayed with traffic.

To reduce the number of nuisance alerts due to proximate aircraft, the **“Traffic”** voice alert is generated only when the number of TAs increases. For example, when the first TA is displayed, a voice and visual annunciation are generated. As long as a single TA remains on the display, no additional voice alerts are generated. If a second TA appears on the display or if the number of TAs initially decreases and then subsequently increases, another voice alert is generated.

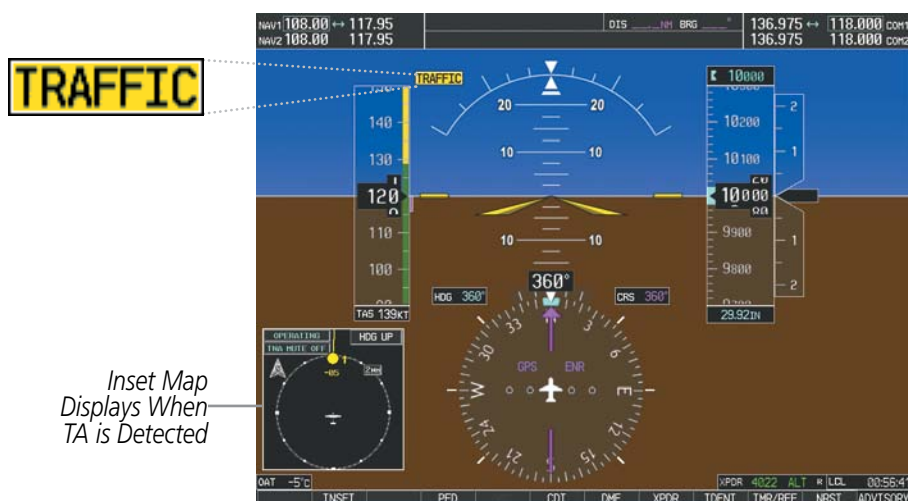

Figure 6-158 Traffic Annunciation (PFD)

A **“TIS Not Available”** (TNA) voice alert is generated when the TIS service becomes unavailable or is out of range. TIS may be unavailable in the radar coverage area due to the following:

- Radar site TIS Mode S sensor is not operational or is out of service
- Traffic or requesting aircraft is beyond the maximum range of the TIS-capable Mode S radar site.
- Traffic or requesting aircraft is above the radar site in the cone of silence and out of range of an adjacent site.
- Traffic or requesting aircraft is below radar coverage. In flat terrain, the coverage extends from about 3000 feet upward at 55 miles. Terrain and obstacles around the radar site can further decrease radar coverage in all directions.
- Traffic does not have an operating transponder.

The **“TIS Not Available”** (TNA) voice alert can be manually muted to reduce nuisance alerting. TNA muting status is shown in the upper left corner of the Traffic Map Page.

Muting the “TIS Not Available” voice alert:

- 1) Select the Traffic Map Page.
- 2) Press the **TNA MUTE** Softkey. The status is displayed in the upper left corner of the Traffic Map Page.

Or:

- a) Press the **MENU** Key.
- b) Select “Not Available” Mute On’ (shown if TNA muting is currently off) and press the **ENT** Key.

SYSTEM STATUS

The G1000 performs an automatic test of TIS during power-up. If TIS passes the test, TIS enters Standby Mode (on the ground) or Operating Mode (in the air). If TIS fails the power up test, an annunciation is shown in the center of the Traffic Map Page.

Traffic Map Page Annunciation	Description
NO DATA	Data is not being received from the transponder*
DATA FAILED	Data is being received from the transponder, but a failure is detected in the data stream*
FAILED	The transponder has failed*
UNAVAILABLE	TIS is unavailable or out of range

* Contact a service center or Garmin dealer for corrective action

Table 6-24 TIS Failure Annunciations

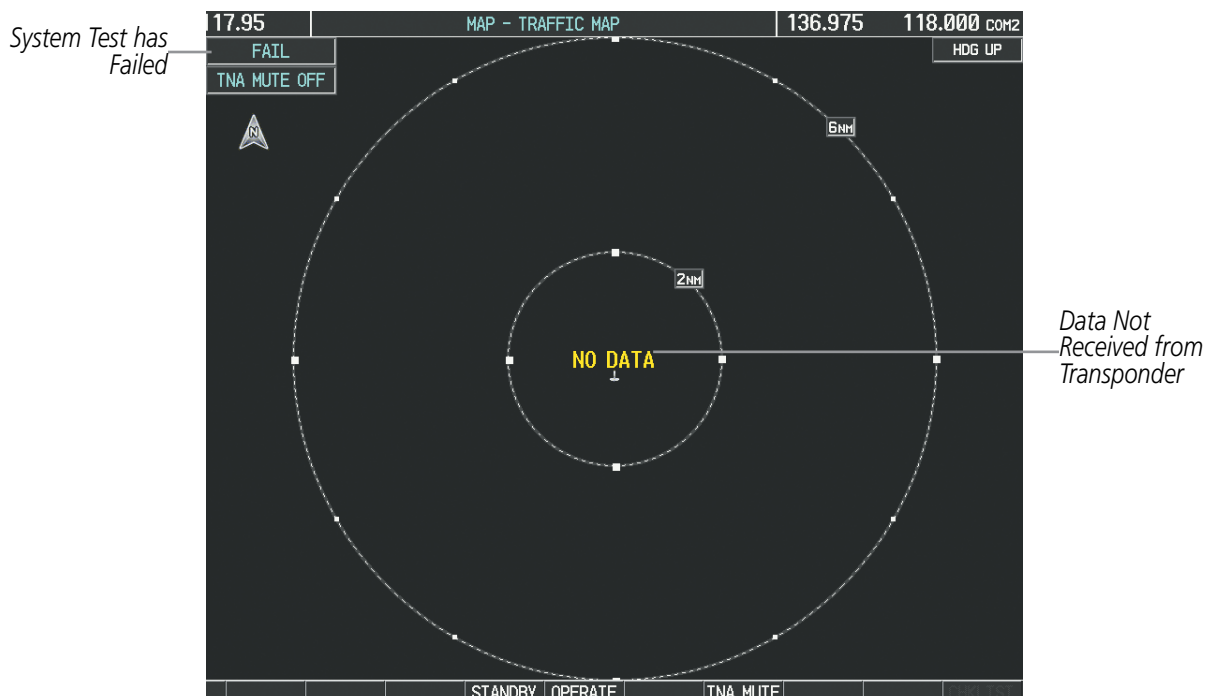





Figure 6-159 TIS Power-up Test Failure

The traffic mode is annunciated in the upper left corner of the Traffic Map Page. When the aircraft is on the ground, TIS automatically enters Standby Mode. If traffic is selected for display on another map while Standby Mode is selected, the traffic display enabled icon is crossed out (also the case whenever TIS has failed). Once the aircraft is airborne, TIS switches to Operating Mode and traffic information is displayed. The mode can be changed manually using softkeys or the page menu.

Mode	Traffic Mode Annunciation (Traffic Map Page)	Traffic Display Enabled Icon (Other Maps)
TIS Operating	OPERATING	
TIS Standby	STANDBY (also shown in white in center of page)	
TIS Failed*	FAIL	

* See Table 6-26 for additional failure annunciations

Table 6-25 TIS Modes

Switching between TIS modes:

- 1) Select the Traffic Map Page.
- 2) Press the **STANDBY** or **OPERATE** Softkey to switch between modes. The mode is displayed in the upper left corner of the Traffic Map Page.

Or:

- a) Press the **MENU** Key.
- b) Select 'Operate Mode' or 'Standby Mode' (choice dependent on current state) and press the **ENT** Key. The annunciations to indicate the status of traffic information appear in a banner at the lower left corner of maps on which traffic can be displayed (Table 6-26).

Traffic Status Banner Annunciation	Description
TA OFF SCALE	A Traffic Advisory is outside the selected display range* Annunciation is removed when traffic comes within the selected display range
TA X.X ± XX ↓	System cannot determine bearing of Traffic Advisory** Annunciation indicates distance in nm, altitude separation in hundreds of feet, and altitude trend arrow (climbing/descending)
AGE MM:SS	Appears if traffic data is not refreshed within 6 seconds If after another 6 seconds data is not received, traffic is removed from the display The quality of displayed traffic information is reduced as the age increases
TRFC COAST	The displayed data is not current (6 to 12 seconds since last message) The quality of displayed traffic information is reduced when this message is displayed
TRFC RMVD	Traffic is removed because it is too old for coasting (12 to 60 seconds since last message) Traffic may exist within the selected display range, but it is not displayed
TRFC FAIL	Traffic data has failed
NO TRFC DATA	Traffic has not been detected
TRFC UNAVAIL	The traffic service is unavailable or out of range

*Shown as symbol on Traffic Map Page

**Shown in center of Traffic Map Page

Table 6-26 TIS Traffic Status Annunciations

6.10 GARMIN GTS 800 TRAFFIC



WARNING: The GTS 800 Traffic Advisory System (TAS) is intended for advisory use only to aid the pilot in visually acquiring traffic. No avoidance maneuvers should be based solely upon TAS traffic information. It is the responsibility of the pilot in command to see and maneuver to avoid traffic.



NOTE: Pilots should be aware of TAS system limitations. TAS systems require transponders of other aircraft to respond to system interrogations. If the transponders do not respond to interrogations due to phenomena such as antenna shading or marginal transponder performance, traffic may be displayed intermittently, or not at all. Aircraft without altitude reporting capability are shown without altitude separation data or climb descent indication. Pilots should remain vigilant for traffic at all times.



NOTE: TIS is disabled when TAS is installed.

The optional Garmin GTS 800 is a Traffic Advisory System (TAS). It enhances flight crew situational awareness by displaying traffic information for transponder-equipped aircraft. The system also provides visual and aural traffic alerts including voice announcements to assist in visually acquiring traffic.

The GTS 800 is capable of tracking up to 45 intruding aircraft equipped with Mode A or C transponders, and up to 30 intruding aircraft equipped with Mode S transponders. A maximum of 30 aircraft with the highest threat potential can be displayed simultaneously. No TAS surveillance is provided for aircraft without operating transponders.

THEORY OF OPERATION

When the GTS 800 is in Operating Mode, the unit interrogates the transponders of intruding aircraft while monitoring transponder replies. The system uses this information to derive the distance, relative bearing, and if reported, the altitude and vertical trend for each aircraft within its surveillance range. The GTS 800 then calculates a closure rate to each intruder based on the projected Closest Point of Approach (CPA). If the closure rate meets the threat criteria for a Traffic Advisory (TA), visual and aural alerting is provided.

TAS SURVEILLANCE VOLUME

The GTS 800 surveillance system monitors the airspace within $\pm 10,000$ feet of own altitude. Under ideal conditions, the GTS 800 unit scans transponder traffic up to 12 nm in the forward direction. The range is somewhat reduced to the sides and aft of own aircraft due to the directional interrogation signal patterns. In areas of greater transponder traffic density or when TCAS II (Traffic Alert and Collision Avoidance System II) systems are detected, the GTS 800 automatically reduces its interrogation transmitter power (and therefore range) in order to limit potential interference from other signals.

When paired with a 1090 MHz extended squitter transponder, the GTS 800 uses Automatic Dependent Surveillance - Broadcast (ADS-B) data from participating airborne aircraft transponders to enhance the positional accuracy and display of traffic within the TAS surveillance range. Traffic data supplied only by ADS-B Ground Based Transceivers (GBTs) is not displayed.

TAS SYMBOLOGY

The GTS 800 uses symbology to depict intruding traffic using the symbols shown in Table 6-27.









Symbol	Description
	Traffic Advisory (TA) arrow with ADS-B directional information. Points in the direction of the intruder aircraft track. (Not available in all installations.)
	Traffic Advisory without ADS-B directional information.
	Traffic Advisory out of the selected display range. Displayed at outer range ring at proper bearing.
	Proximity Advisory (PA) arrow with ADS-B directional information. Points in the direction of the aircraft track. (Not available in all installations.)
	Proximity Advisory without ADS-B directional information.
	Non-threat traffic arrow with ADS-B directional information. Points in the direction of the intruder aircraft track. (Not available in all installations.)
	Non-Threat Traffic without ADS-B directional information
	PA or Non-threat traffic arrow with ADS-B directional information, but positional accuracy is degraded. Points in the direction of the aircraft track. (Not available in all installations.)

Table 6-27 GTS 800 Traffic Symbols

A Traffic Advisory (TA), displayed as a yellow circle or triangle, alerts the crew to a potentially hazardous intruding aircraft, if the closing rate, distance, and vertical separation meet TA criteria. A Traffic Advisory that is beyond the selected display range (off scale) is indicated by a half TA symbol at the edge of the screen at the relative bearing of the intruder.

A Proximity Advisory (PA), displayed as a solid white diamond or triangle, indicates the intruding aircraft is within ±1200 feet and is within a 6 nm range, but is still not considered a TA threat.

A Non-threat Advisory, shown as an open white diamond or triangle, is displayed for traffic beyond 6 nm that is neither a TA or PA.

A solid white rounded arrow indicates either a PA or Non-Threat traffic with ADS-B directional information, but the position of the traffic is shown with degraded accuracy.

Relative altitude, when available, is displayed above or below the corresponding intruder symbol in hundreds of feet (Figure 6-160). When this altitude is above own aircraft, it is preceded by a '+' symbol; a minus sign '-' indicates traffic is below own aircraft.

A vertical trend arrow to the right of the intruder symbol (Figure 6-160) indicates climbing or descending traffic with an upward or downward-pointing arrow respectively.

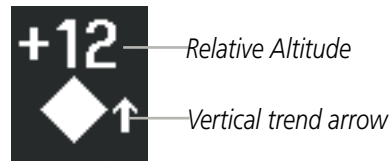

Figure 6-160 Intruder Altitude and Vertical Trend Arrow

If the intruding aircraft is providing ADS-B track information, this is displayed as a vector line extending beyond the traffic symbol in the direction of the track (Figure 6-161).

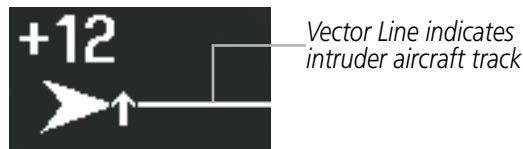

Figure 6-161 Intruder Traffic with ADS-B Directional Information and Track

Flight IDs may also be displayed with traffic symbols; see the Flight IDs discussion in this section for more information.

On-ground aircraft with Mode S transponders are not displayed.

TA ALERTING CONDITIONS

The GTS 800 automatically adjusts its TA sensitivity level to reduce the likelihood of nuisance TA alerting during flight phases likely to be near airports. The system uses Level A TA sensitivity when the groundspeed is less than 120 knots; Level B TA sensitivity applies in all other conditions.

Sensitivity Level	Intruder Altitude Available	TA Alerting Conditions
A	Yes	Intruder closing rate provides less than 20 seconds of vertical and horizontal separation. Or: Intruder closing rate provides less than 20 seconds of horizontal separation and vertical separation is within 600 feet. Or: Intruder range is within 0.2 nm and vertical separation is within 600 feet.
A	No	Intruder closing rate provides less than 15 seconds of separation.
B	Yes	Intruder closing rate provides less than 30 seconds of vertical and horizontal separation. Or: Intruder closing rate provides less than 30 seconds of horizontal separation and vertical separation is within 800 feet. Or: Intruder range is within 0.55 nm and vertical separation is within 800 feet.
B	No	Intruder range is less than 20 seconds.

Table 6-28 TA Sensitivity Level and TA Alerting Criteria

TAS ALERTS



NOTE: Aural traffic alerts do not occur when the landing gear is extended. Only visual traffic annunciations are issued.

When the GTS 800 detects a new TA, the following occur:

- A single **“Traffic!”** voice alert is generated, followed by additional voice information about the bearing, relative altitude, and approximate distance from the intruder that triggered the TA (Table 6-29). The announcement **“Traffic! 12 o’clock, high, four miles,”** would indicate the traffic is in front of own aircraft, above own altitude, and approximately four nautical miles away.
- A TRAFFIC Annunciation appears at the top right of the airspeed on the PFD, flashing for five seconds and remains displayed until no TAs are detected in the area (Figure 6-162).
- The PFD Inset Map is automatically displayed with TA traffic.

If the bearing of TA traffic cannot be determined, a yellow text banner will be displayed in the center of the Traffic Map Page and in the lower-left of the PFD inset map instead of a TA symbol. The text will indicate “TA” followed by the distance, relative altitude, and vertical trend arrow for the TA traffic, if known.

A TA will be displayed for at least eight seconds, even if the condition(s) that initially triggered the TA are no longer present.

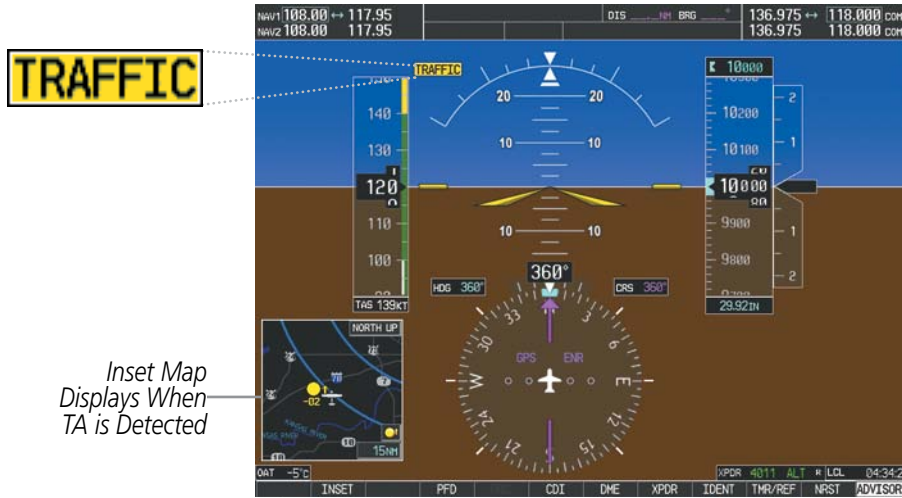

Figure 6-162 Traffic Annunciation (PFD)

Bearing	Relative Altitude	Distance (nm)
“One o’clock” through “Twelve o’clock” or “No Bearing”	“High”, “Low”, “Same Altitude” (if within 200 feet of own altitude), or “Altitude not available”	“Less than one mile”, “One Mile” through “Ten Miles”, or “More than ten miles”

Table 6-29 TA Descriptive Voice Announcements

SYSTEM TEST



NOTE: Traffic surveillance is not available during the system test. Use caution when performing a system test during flight.

The GTS 800 provides a system test mode to verify the TAS system is operating normally. The test takes ten seconds to complete. When the system test is initiated, a test pattern of traffic symbols is displayed on the Traffic Map Page (Figure 6-163). If the system test passes, the aural announcement “**TAS System Test Passed**” is heard, otherwise the system announces “**TAS System Test Failed.**” When the system test is complete, the traffic system enters Standby Mode.

Testing the traffic system:

- 1) Turn the large **FMS** Knob to select the Map Page Group.
- 2) Turn the small **FMS** Knob to select the Traffic Map Page.

- 3) Turn the **Range** knob to set the range to 2/6 nm to allow for full test pattern to be displayed during test.
 - 4) Press the **TEST** Softkey.
- Or:
- 1) Press the **MENU** Key and turn the small **FMS** knob to select 'Test Mode'.
 - 2) Press the **ENT** Key.

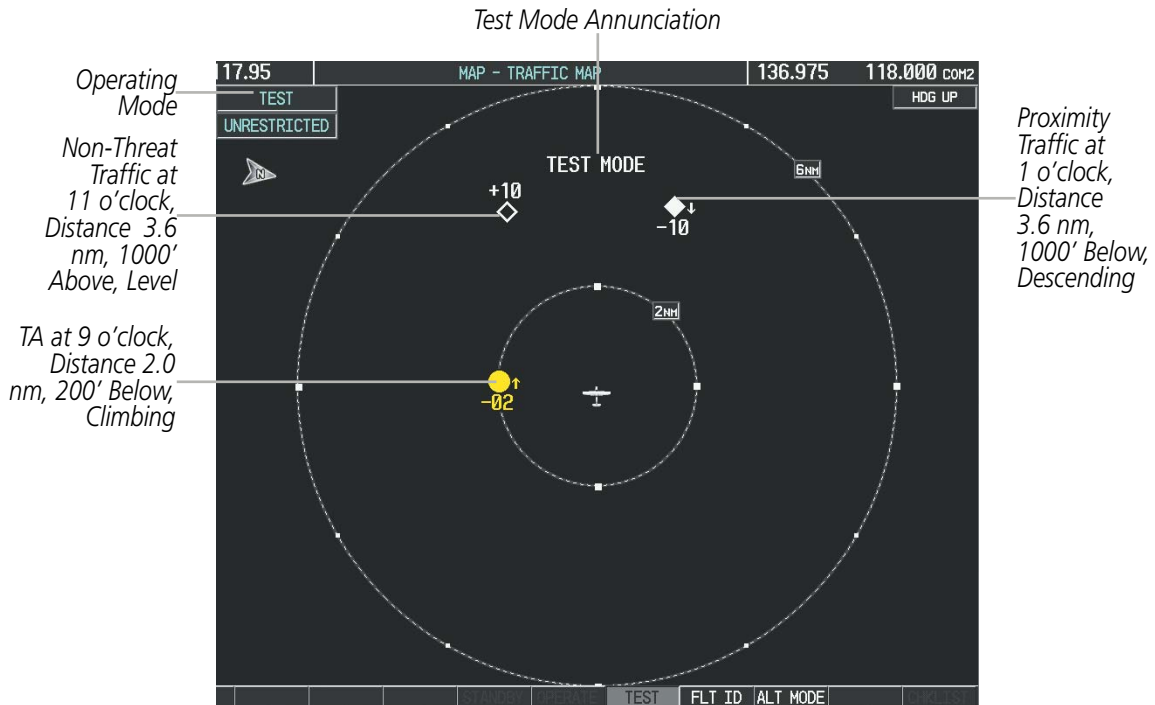

Figure 6-163 System Test in Progress with Test Pattern

OPERATION

NOTE: The GTS 800 automatically transitions from **STANDBY** to **OPERATE** mode eight seconds after takeoff. The unit also automatically transitions from **OPERATE** to **STANDBY** mode 24 seconds after landing.

After power-up, the GTS 800 is in Standby Mode. The GTS 800 must be in Operating Mode for traffic to be displayed and for TAs to be issued.

Selecting the **OPERATE** Softkey allows the traffic unit to switch from Standby Mode to Operating Mode as necessary. Selecting the **STANDBY** Softkey forces the unit into Standby Mode.

Switching from operating mode to standby mode:

On the Traffic Page, select the **STANDBY** Softkey

Or:

- 1) Press the **MENU** Key and turn the small **FMS** knob to select 'Standby Mode'.
- 2) Press the **ENT** Key.

Switching from standby mode to operating mode:

On the Traffic Page, select the **OPERATE** Softkey

Or:

- 1) Press the **MENU** Key and turn the small **FMS** knob to select 'Operate Mode'.
- 2) Press the **ENT** Key. The traffic unit switches from Standby Mode to Operating Mode as necessary.

TRAFFIC MAP PAGE

The Traffic Map Page shows surrounding TAS traffic data in relation to the aircraft's current position and altitude, without basemap clutter. It is the principal map page for viewing traffic information. Aircraft orientation is always heading up unless there is no valid heading. Map range is adjustable with the **RANGE** Knob, as indicated by the map range rings.

The traffic mode and altitude display mode are annunciated in the upper left corner of the page.

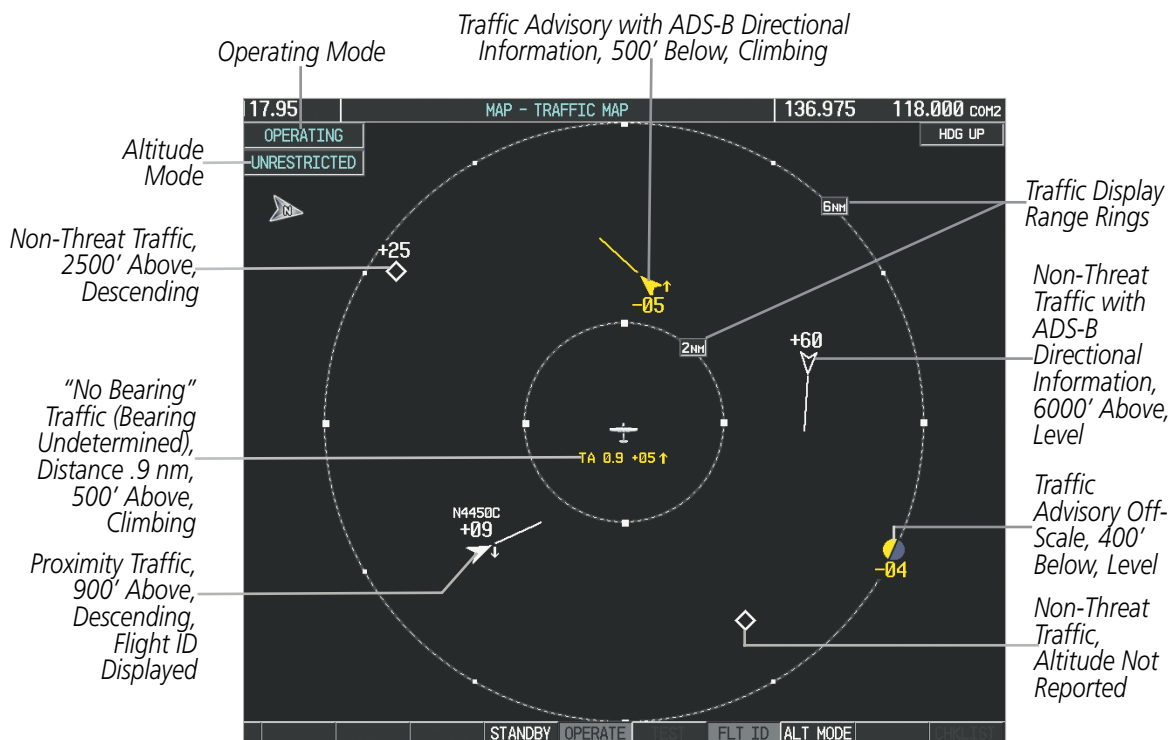

Figure 6-164 Traffic Map Page

Displaying traffic on the Traffic Map Page:

- 1) Turn the large **FMS** Knob to select the Map Page Group.
- 2) Turn the small **FMS** Knob to select the Traffic Map Page.
- 3) Press the **OPERATE** Softkey to begin displaying traffic. OPERATING is displayed in the Traffic mode field.
- 4) Press the **STANDBY** Softkey to place the system in the Standby mode. STANDBY is displayed in the Traffic mode field.
- 5) Turn the **RANGE** Knob clockwise to display a larger area or counter-clockwise to display a smaller area.

ALTITUDE DISPLAY

The pilot can select the volume of airspace in which non-threat and proximity traffic is displayed. TAs occurring outside of these limits will always be shown.

Changing the altitude range:

- 1) On the Traffic Map Page, select the **ALT MODE** Softkey.
- 2) Press **S** one of the following Softkeys:
 - **ABOVE:** Displays non-threat and proximity traffic from 9000 feet above the aircraft to 2700 feet below the aircraft. Typically used during climb phase of flight.
 - **NORMAL:** Displays non-threat and proximity traffic from 2700 feet above the aircraft to 2700 feet below the aircraft. Typically used during enroute phase of flight.
 - **BELOW:** Displays non-threat and proximity traffic from 2700 feet above the aircraft to 9000 feet below the aircraft. Typically used during descent phase of flight.
 - **UNREST** (unrestricted): All traffic is displayed from 9900 feet above and 9900 feet below the aircraft.
- 3) To return to the Traffic Page, press the **BACK** Softkey.
Or:
 - 1) Press the **MENU** Key.
 - 2) Turn the small **FMS** Knob to select one of the following (see softkey description in step 2 above):
 - ABOVE
 - NORMAL
 - BELOW
 - UNRESTRICTED
 - 3) Press the **ENT** Key.

FLIGHT ID DISPLAY

The Flight IDs of other aircraft (when available) can be enabled for display on the Traffic Map Page (Figure 6-165). When a flight ID is received, it will appear above or below the corresponding traffic symbol on the Traffic Map Page when this option is enabled.

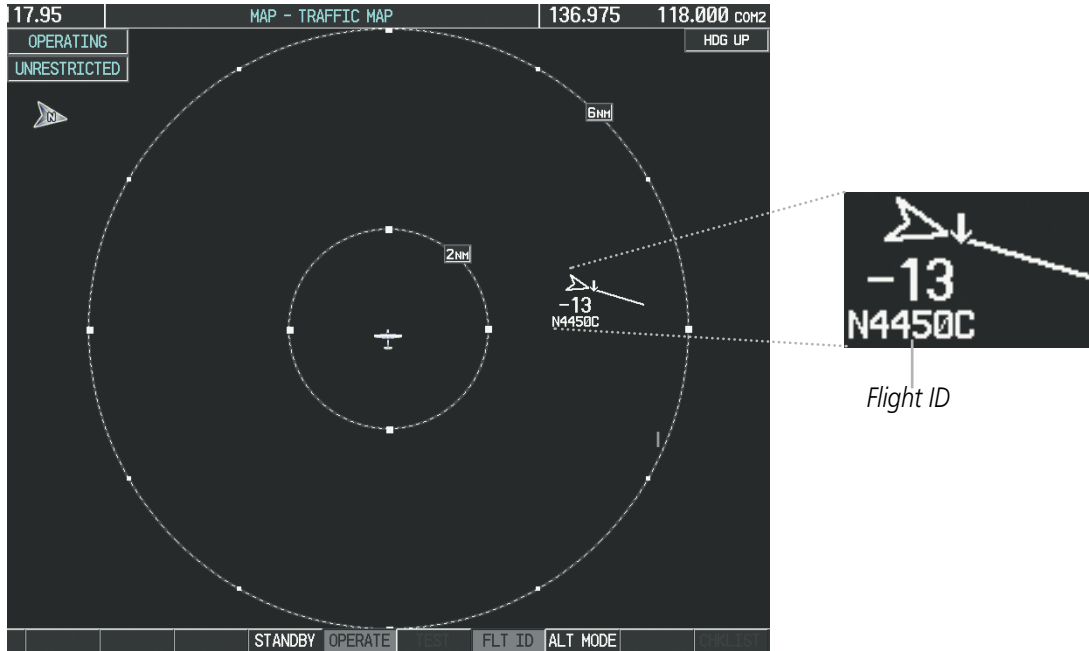

Figure 6-165 Traffic Map Page with Flight ID Enabled

Enabling/Disabling Flight ID Display:

On the Traffic Map Page, press the **FLT ID** Softkey.

Or:

- 1) Press the **MENU** Key.
- 2) Turn the small **FMS** Knob to choose 'Show Flight IDs' or 'Hide Flight IDs' (choice dependent on current state) (Figure 6-166).
- 3) Press the **ENT** Key.

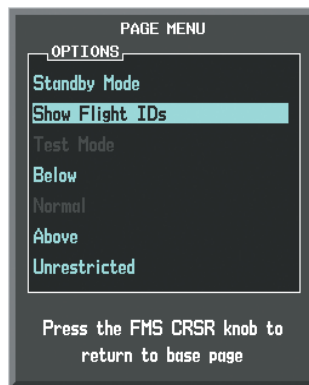

Figure 6-166 Traffic Map Page Menu

TRAFFIC MAP PAGE DISPLAY RANGE

The display range on the Traffic Map Page can be changed at any time. Map range is adjustable with the **RANGE** Knob, as indicated by the map range rings.

Changing the display range on the Traffic Map Page:

- 1) Turn the **RANGE** Knob.
- 2) The following range options are available:
 - 2 nm
 - 2 and 6 nm
 - 6 and 12 nm

ADDITIONAL TRAFFIC DISPLAYS

Traffic information can be displayed on the following maps on the MFD when the unit is operating:

- Navigation Map Page
- Traffic Map Page
- Trip Planning Page
- Nearest Pages
- Active Flight Plan Page
- System Pages
- Video Page

Traffic information can also be displayed on the PFD when the Synthetic Vision System (SVS) option is installed and enabled. See the Additional Features Section for details.

Displaying traffic information (MFD maps other than the Traffic Map Page):

- 1) Select the **MAP** Softkey.
- 2) Press the **TRAFFIC** Softkey. Traffic is now displayed on the map.

When traffic is selected on maps other than the Traffic Map Page, a traffic icon is shown to indicate traffic is enabled for display (Figure 6-167).

Displaying traffic on the Navigation Map

- 1) Ensure the traffic system is operating. With the Navigation Map displayed, press the **MAP** Softkey.
- 2) Press the **TRAFFIC** Softkey. Traffic is now displayed on the map as shown in the figure.



Figure 6-167 TAS Traffic on Navigation Map

Customizing the traffic display on the Navigation Map Page:

- 1) Select the Navigation Map Page.
- 2) Press the **MENU** Key.
- 3) With Map Setup highlighted, press the **ENT** Key (Figure 6-168).
- 4) Turn the small **FMS** Knob to select the Traffic Group and press the **ENT** Key (Figure 6-169).
- 5) Turn the large **FMS** Knob or press the **ENT** Key to scroll through the selections (Figure 6-170).
 - TRAFFIC – Turns the display of traffic data on or off
 - TRAFFIC MODE – Selects the traffic mode for display; select from:
 - All Traffic - Displays all traffic
 - TA/PA - Displays Traffic Advisories and Proximity Advisories
 - TA ONLY - Displays Traffic Advisories only
 - TRAFFIC SMBL – Selects the maximum range at which traffic symbols are shown
 - TRAFFIC LBL – Selects the maximum range at which traffic labels are shown with the option to turn off
- 6) Turn the small **FMS** Knob to scroll through options (ON/OFF, range settings, etc.).
- 7) Press the **ENT** Key to select an option.
- 8) Press the **FMS** Knob or **CLR** Key to return to the Navigation Map Page.

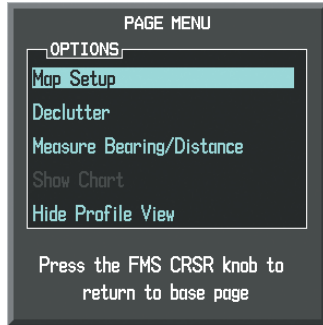

Figure 6-168 Navigation Map Page Menu

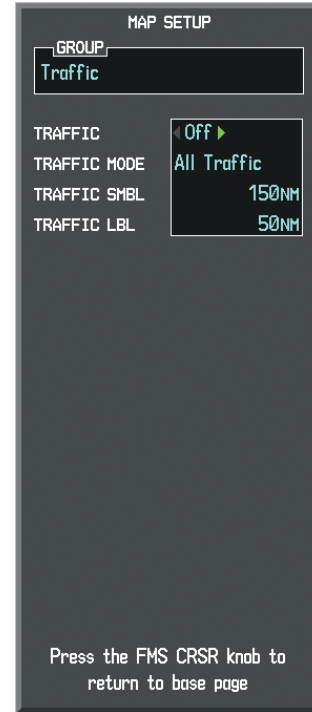

Figure 6-170 Navigation Map Page Setup Menu, Traffic Group



Figure 6-169 Navigation Map Page Setup Menu

The Navigation Map Page Setup Menu also controls the display of traffic. The setup menu controls the map range settings. Traffic data symbols and labels can be decluttered from the display. If a map range larger than the map range setting is selected, the data is removed from the map. Maps besides the Traffic Map Page use settings based on those selected for the Navigation Map Page.

Traffic information can also be displayed on the PFD Inset Map by pressing the **INSET** Softkey. A traffic map will appear in heading up orientation. Traffic information can also be overlaid with navigation, topographic and optional XM Weather data.

Displaying traffic information (PFD Inset Map):

- 1) Press the **INSET** Softkey.
- 2) Press the **TRAFFIC** Softkey to display traffic data on the inset map (TRFC-1).
- 3) Select the softkey again to display the traffic-only inset (TRFC-2).
- 4) Select the softkey again to remove traffic data.

SYSTEM STATUS

The traffic mode is annunciated in the upper left corner of the Traffic Map Page.

Mode	Traffic Mode Annunciation (Traffic Map Page)	Traffic Display Status Icon (Other Maps)
TAS System Test Initiated	TEST (also shown in white in center of page)	
TAS Operating	OPERATING	
TAS Standby	STANDBY (also shown in white in center of page)	
TAS Failed*	FAIL	

* See Table 6-31 for additional failure annunciations

Table 6-30 TAS Modes

If the traffic unit fails, an annunciation as to the cause of the failure is shown in the center of the Traffic Map Page. During a failure condition, the Operating Mode cannot be selected.

Traffic Map Page Center Annunciation	Description
NO DATA	Data is not being received from the TAS unit
DATA FAILED	Data is being received from the TAS unit, but the unit is self-reporting a failure
FAILED	Incorrect data format received from the TAS unit

Table 6-31 TAS Failure Annunciations

The annunciations to indicate the status of traffic information appear in a banner at the lower left corner of maps on which traffic can be displayed.

Traffic Status Banner Annunciation	Description
TA OFF SCALE	A Traffic Advisory is outside the selected display range*. Annunciation is removed when traffic comes within the selected display range.
TA X.X ± XX ↓	System cannot determine bearing of Traffic Advisory**. Annunciation indicates distance in nm, altitude separation in hundreds of feet, and altitude trend arrow (climbing/descending).
TRFC FAIL	TAS unit has failed (unit is self-reporting a failure or sending incorrectly formatted data)
NO TRFC DATA	Data is not being received from the TAS unit

*Shown as symbol on Traffic Map Page

**Shown in center of Traffic Map Page

Table 6-32 TAS Traffic Status Annunciations

6.11 HONEYWELL KTA870 TRAFFIC



NOTE: TIS is disabled when Traffic Advisory System (TAS) is installed.



NOTE: Refer to the Honeywell® KTA 870 Pilot's Guide for a detailed discussion of the KTA 870 TAS.

TAS SYMBOLOGY

The Traffic Advisory System (TAS) is designed to help in detection and avoidance of other aircraft. TAS uses an on-board interrogator-processor and the Mode S transponder for the air-to-air traffic data link. Traffic is displayed with the symbology shown in Table 6-33.

TAS Symbol	Description
	Non-Threat Traffic
	Proximity Advisory (PA)
	Traffic Advisory (TA)
	Traffic Advisory Off Scale

Table 6-33 TAS Symbol Description

A Non-threat Advisory, shown as an open white diamond, indicates that an intruding aircraft is at greater than ± 1200 feet relative altitude or the distance is beyond 5 nm.

A Proximity Advisory indicates that the intruding aircraft is within ± 1200 feet and is within 5 nm range, but is still not considered a threat.

A Traffic Advisory (TA) alerts the crew to a potentially hazardous intruding aircraft. Closing rate, distance, and vertical separation meet TA criteria. A Traffic Advisory that is beyond the selected display range is indicated by a half TA symbol at the edge of the screen at the relative bearing of the intruder.

OPERATION

The KTA 870 must be in Operating Mode for traffic to be displayed. The unit starts in Operating Mode upon power-up.

Selecting the **STANDBY** Softkey places the unit into Standby Mode. Selecting the **NORMAL** Softkey allows the KTA 870 to switch from Standby Mode to Operating Mode as necessary.

Switching from operating mode to standby mode:

- 1) Select the Traffic Map Page.
- 2) Select the **STANDBY** Softkey.

Or:

- 1) Select the Traffic Map Page.
- 2) Press the **MENU** Key and turn the small **FMS** knob to select Standby Mode.
- 3) Press the **ENT** Key.

Switching from standby mode to operating mode:

On the Traffic Page, select the **NORMAL** Softkey

Or:

- 1) Press the **MENU** Key and turn the small **FMS** knob to select 'Normal Mode'.
- 2) Press the **ENT** Key. The KTA 870 switches from Standby Mode to Operating Mode as necessary.

System Self Test

- 1) Turn the large **FMS** Knob to select the Map Page Group.
- 2) Turn the small **FMS** Knob to select the Traffic Map Page.
- 3) Turn the **Range** knob to set the range to 2/6 nm allow for display of full traffic test pattern.
- 4) Select the **TEST** Softkey.

Or:

- 1) Press the **MENU** Key and turn the small **FMS** knob to select 'Test Mode'.
- 2) Press the **ENT** Key.

Self Test takes approximately eight seconds to complete. When completed successfully, traffic symbols are displayed and a voice alert "**TAS System Test OK**" is heard. In the event that the system test fails, the system enters Standby Mode and a voice alert "**TAS System Test Fail**" is heard.

Displaying traffic on the Traffic Map Page:

- 1) Turn the large **FMS** Knob to select the Map Page Group.
- 2) Turn the small **FMS** Knob to select the Traffic Map Page.
- 3) Select the **NORMAL** Softkey to begin displaying traffic. 'OPERATING' is displayed in the Traffic mode field.
- 4) Select the **ALT MODE** Softkey to change the altitude volume.

- 5) Select the **STANDBY** Softkey to place the system in the Standby mode. **STANDBY** is displayed in the Traffic mode field.
- 6) Turn the **RANGE** Knob clockwise to display a larger area or counter-clockwise to display a smaller area.



Figure 6-171 Traffic Map Page

The Traffic Map Page shows surrounding TAS traffic data in relation to the aircraft's current position and altitude, without basemap clutter. Aircraft orientation is always heading up unless there is no valid heading. Map range is adjustable with the **RANGE** Knob from 2 to 40 nm, as indicated by the map range rings.

The traffic mode and altitude display mode are annunciated in the upper left corner.

DISPLAYING TRAFFIC DATA

The Map - Traffic Map Page is the principal page for viewing traffic information. Additional displays of traffic information are available as map overlays while the traffic system is operating, and serve as additional reference to the Traffic Map Page. Traffic information can be displayed on the following maps and pages:

- PFD Inset Map
- Nearest Pages
- Navigation Map Page
- Active Flight Plan Page
- Traffic Map Page
- Video Page
- Trip Planning Page

Traffic information can also be displayed on the PFD when the Synthetic Vision System (SVS) option is installed and enabled. See the Additional Features Section for details.

Displaying traffic information (maps other than the Traffic Map Page):

- 1) Select the **MAP** Softkey.
- 2) Select the **TRAFFIC** Softkey. Traffic is now displayed on the map.

When traffic is selected on maps other than the Traffic Map Page, a traffic icon is shown to indicate TAS is enabled for display.

Displaying traffic on the Navigation Map

- 1) Ensure that the TAS system is operating. With the Navigation Map displayed, select the **MAP** Softkey.
- 2) Select the **TRAFFIC** Softkey. Traffic is now displayed on the map as shown in the figure.



Figure 6-172 TAS Traffic on Navigation Map

Displaying traffic information (PFD Inset Map):

- 1) Select the **INSET** Softkey.
- 2) Select the **TRAFFIC** Softkey to display traffic data on the inset map (TRFC-1).
- 3) Select the softkey again to display the traffic-only inset (TRFC-2).
- 4) Select the softkey again to remove traffic data.

ALTITUDE DISPLAY

The pilot can select the volume of airspace in which traffic is displayed. Traffic Advisories (TAs) outside of these limits will still be shown. Refer to the KTA 870 Pilot's Guide for specific display thresholds.

Changing the altitude display mode:

- 1) On the Traffic Page, select the **ALT MODE** Softkey.
 - 2) Select one of the following Softkeys:
 - **BELOW**
 - **NORMAL**
 - **ABOVE**
 - **UNREST** (unrestricted)
 - 3) To return to the Traffic Page, select the **BACK** Softkey.
- Or:**
- 1) Press the **MENU** Key.
 - 2) Turn the small **FMS** Knob to select one of the following:
 - **BELOW**
 - **NORMAL**
 - **ABOVE**
 - **UNREST** (unrestricted)
 - 3) Select the **ENT** Softkey.

TRAFFIC MAP PAGE DISPLAY RANGE

The display range on the Traffic Map Page can be changed at any time. Map range is adjustable with the **RANGE** Knob from 2 to 40 nm, as indicated by the map range rings.

Changing the display range on the Traffic Page:

- 1) Turn the **RANGE** Knob.
- 2) The following range options are available:
 - 2 nm
 - 2 and 6 nm
 - 6 and 12 nm
 - 12 and 24 nm
 - 24 and 40 nm

Customizing the traffic display on the Navigation Map Page:

- 1) Select the Navigation Map Page.
- 2) Press the **MENU** Key.
- 3) With Map Setup highlighted, press the **ENT** Key (Figure 6-173).
- 4) Turn the small **FMS** Knob to select the Traffic Group and press the **ENT** Key (Figure 6-174).
- 5) Turn the large **FMS** Knob or press the **ENT** Key to scroll through the selections (Figure 6-175).
 - TRAFFIC – Turns the display of traffic data on or off
 - TRAFFIC MODE – Selects the traffic mode for display; select from:
 - All Traffic - Displays all traffic
 - TA/PA - Displays Traffic Alerts and Proximity Advisories
 - TA ONLY - Displays Traffic Alerts only
 - TRAFFIC SMBL – Selects the maximum range at which traffic symbols are shown
 - TRAFFIC LBL – Selects the maximum range at which traffic labels are shown with the option to turn off
- 6) Turn the small **FMS** Knob to scroll through options (ON/OFF, range settings, etc.).
- 7) Press the **ENT** Key to select an option.
- 8) Press the **FMS** Knob or **CLR** Key to return to the Navigation Map Page.



Figure 6-173 Navigation Map Page Menu



Figure 6-174 Navigation Map Page Setup Menu

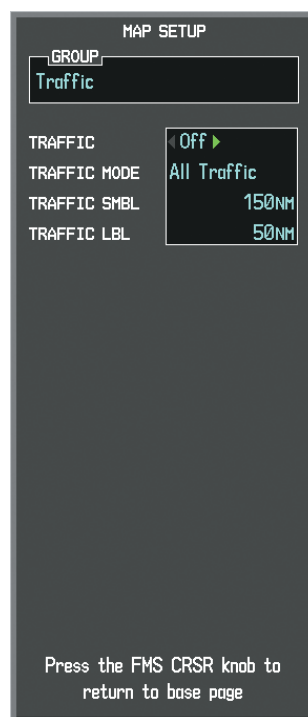

Figure 6-175 Navigation Map Page Setup Menu, Traffic Group

The Navigation Map Page Setup Menu also controls the display of traffic. The setup menu controls the map range settings. Traffic data symbols and labels can be decluttered from the display. If a map range larger than the map range setting is selected, the data is removed from the map. Maps besides the Traffic Map Page use settings based on those selected for the Navigation Map Page.

TAS ALERTS



NOTE: Refer to the KTA 870 documentation for information on alerts generated by the TAS equipment.

When the number of TAs on the Traffic Map Page increases from one scan to the next, the following occur:

- A **“Traffic, Traffic”** voice alert is generated when the first TA is displayed.
- A TRAFFIC Annunciation appears at the top right of the airspeed on the PFD, flashing for 5 seconds and remaining displayed until no TAs are detected in the area.
- The PFD Inset Map is automatically displayed with TA traffic.
- A single **“Traffic”** voice alert is generated when the number of TAs increases.

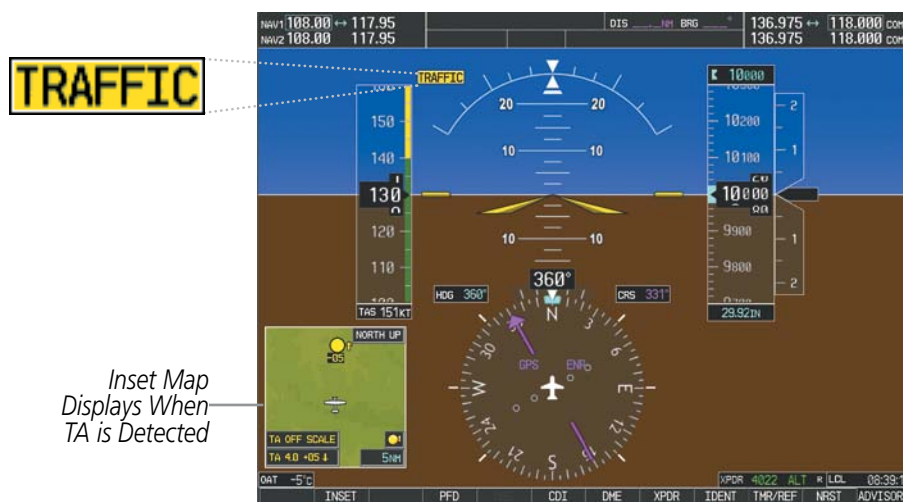

Figure 6-176 Traffic Annunciation (PFD)

SYSTEM STATUS

The traffic mode is annunciated in the upper left corner of the Traffic Map Page.

Mode	Traffic Mode Annunciation (Traffic Map Page)	Traffic Display Enabled Icon (Other Maps)
TAS Self-test Initiated	TEST (also shown in white in center of page)	
TAS Operating	OPERATING	
TAS Standby	STANDBY (also shown in white in center of page)	
TAS Failed*	FAIL	

* See Table 6-35 for additional failure annunciations

Table 6-34 TAS Modes

If the unit fails, an annunciation as to the cause of the failure is shown in the center of the Traffic Map Page.

Traffic Map Page Annunciation	Description
NO DATA	Data is not being received from the TAS unit
DATA FAILED	Data is being received from the TAS unit, but the unit is self-reporting a failure
FAILED	Incorrect data format received from the TAS unit

Table 6-35 TAS Failure Annunciations

The annunciations to indicate the status of traffic information appear in a banner at the lower left corner of maps on which traffic can be displayed.

Traffic Status Banner Annunciation	Description
TA OFF SCALE	A Traffic Advisory is outside the selected display range* Annunciation is removed when traffic comes within the selected display range
TA X.X ± XX ↓	System cannot determine bearing of Traffic Advisory** Annunciation indicates distance in nm, altitude separation in hundreds of feet, and altitude trend arrow (climbing/descending)
TRFC FAIL	TAS unit has failed (unit is self-reporting a failure or sending incorrectly formatted data)
NO TRFC DATA	Data is not being received from the TAS unit

*Shown as symbol on Traffic Map Page

**Shown in center of Traffic Map Page

Table 6-36 TAS Traffic Status Annunciations

6.12 ADS-B TRAFFIC

The Automatic Dependent Surveillance-Broadcast (ADS-B) Traffic function allows you to view other traffic in the area, when a GDL 90 data link radio is installed.



Figure 6-177 ADS-B System

ADS-B is a surveillance technology being deployed in selected areas. ADS-B broadcasts a radio transmission approximately once per second containing the aircraft's position, velocity, identification, and other information. ADS-B can also receive reports from other suitably equipped aircraft within reception range. Additionally, these broadcasts can be received by Ground Based Transceivers (GBTs) and used to provide air traffic surveillance services. No ground infrastructure is necessary for ADS-B equipped aircraft to detect each other.

In the United States, two different data links have been adopted for use with ADS-B: 1090 MHz Extended Squitter (1090 ES) and the Universal Access Transceiver (UAT). The GDL 90 is a Universal Access Transceiver (UAT). The UAT link is intended for use by aircraft that primarily operate at 18,000 feet and below. The UAT link supports Flight Information Services-Broadcast (FIS-B).

ADS-B enables improved surveillance services, both air-to-air and air-to-ground, especially in areas where radar is ineffective due to terrain or where it is impractical or cost prohibitive. Initial applications of air-to-air ADS-B are for "advisory" use only, enhancing a pilot's visual acquisition of other nearby equipped aircraft either when airborne or on the airport surface.

ADS-B is intended to be used both in-flight and on the airport surface. ADS-B systems should be turned "on" -- and remain "on" -- whenever operating in the air and on the airport surface, unless a change to "standby" was requested by ATC.

The ADS-B cockpit display of traffic is NOT intended to be used as a collision avoidance system and does not relieve the pilot's responsibility to "see and avoid" other aircraft. ADS-B shall not be used for avoidance maneuvers during IMC or other times when there is no visual contact with the other target aircraft. ADS-B is intended only to assist in visual acquisition of other aircraft. **No avoidance maneuvers are provided for, nor authorized, as a direct result of an ADS-B target being displayed in the cockpit.**



NOTE: Use of ADS-B surveillance services is limited to the service volume of the Ground-Based Transceiver (GBT). The coverage volume of GBTs is limited to line-of-sight..

TRAFFIC DESCRIPTION

ADS-B is limited to displaying traffic in the G1000. Operation is similar to the TAS system discussed previously, with the exception of symbology. The symbols used to display ADS-B traffic are shown in tables below. Above or below the traffic symbol is the traffic identifier, and altitude. A small up or down arrow next to the traffic symbol indicates that the traffic is climbing or descending at a rate of at least 500 feet per minute. The vector line that extends beyond the point of the traffic arrow is just further indication of the intruder aircraft track.

Symbol	Description
	Traffic Advisory with directional information. Points in the direction of the intruder aircraft track.
	Traffic Advisory without directional information.
	Traffic Advisory out of the selected display range. Displayed at outer range ring at proper bearing.
	Proximity Advisory with directional information. Points in the direction of the aircraft track.
	Non-threat traffic with no directional information.
	Non-threat traffic with directional information. Points in the direction of the intruder aircraft track.
	Traffic located on the ground with directional information. Points in the direction of the aircraft track. Ground traffic is only displayed when own aircraft is below 1,000 feet AGL or on the ground.
	Ground traffic without directional information. Ground traffic is only displayed when own aircraft is below 1,000 feet AGL or on the ground.
	Non-aircraft ground traffic. Ground traffic is only displayed when own aircraft is below 1,000 feet AGL or on the ground.
	Traffic with directional information, but positional accuracy is degraded. Points in the direction of the aircraft track.

Table 6-37 ADS-B Traffic Symbology

The following Traffic symbols are displayed on the PFD when the Synthetic Vision System (SVS) option is installed and enabled. See the Additional Features Section for details.





ADS-B Symbol on the PFD (SVS Only)	Description
	Proximity Advisory (PA)
	Traffic Advisory (TA)
	Non-threat traffic

Table 6-38 PFD ADS-B Symbology (SVS Only)



NOTE: Traffic Alerts are only provided for target aircraft within 1.0 nautical mile. Traffic that is more than 1.0 nautical mile is depicted using the bullet symbol .

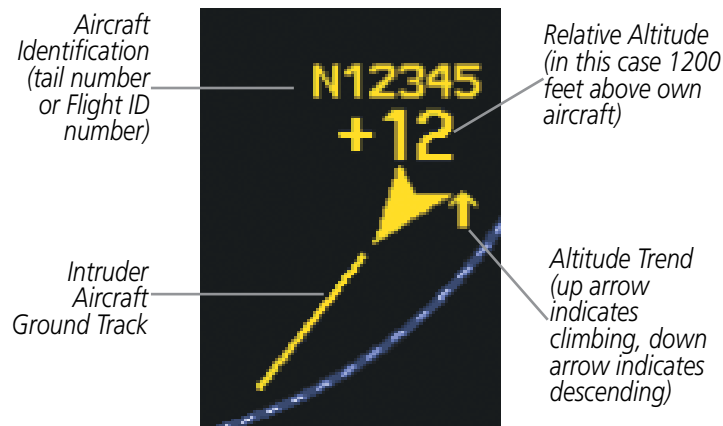

Figure 6-178 Example ADS-B Traffic Advisory

OPERATING MODES

The unit must be in operating mode for traffic to be displayed.



NOTE: The GDL 90 listens to the transponder and follows the transponder mode. The only additional ADS-B mode control is altitude mode.

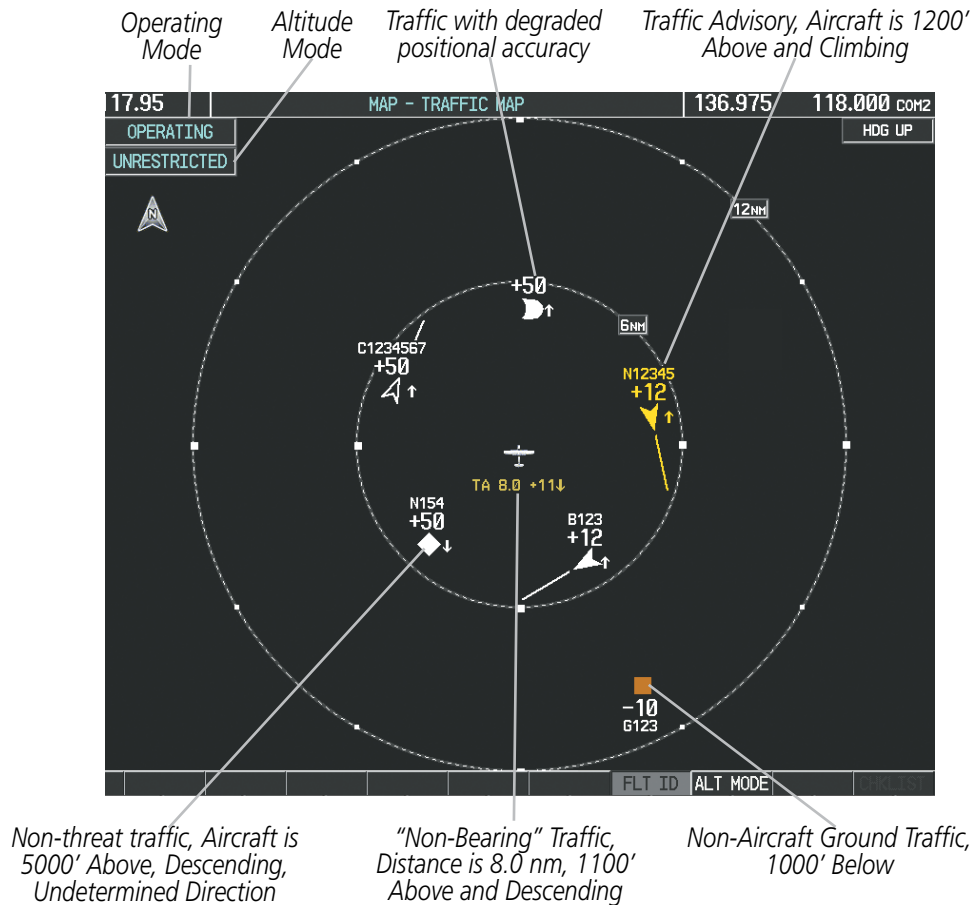

Figure 6-179 ADS-B Traffic Map Page

Displaying traffic on the Traffic Map Page:

- 1) Turn the large **FMS** knob to select the Map Page Group.
- 2) Turn the small **FMS** knob to select the Traffic Map Page.

Changing the altitude display mode:

- 1) On the Traffic Page, press the **ALT MODE** Softkey.
- 2) Press one of the following softkeys:
 - **BELOW**, **NORMAL**, **ABOVE**, or **UNREST** (unrestricted)
- 3) To return to the Traffic Page, press the **BACK** Softkey.

Or:

- 1) Press the **MENU** Key and turn the small **FMS** Knob to select one of the following:
 - **BELOW, NORMAL, ABOVE, or UNREST** (unrestricted)
- 2) Press the **ENT** Key.

Changing the display range on the Traffic Page:

- 1) Turn the **RANGE** Knob.
- 2) The following range options are available:
 - 2 nm
 - 2 and 6 nm
 - 6 and 12 nm
 - 12 and 24 nm
 - 24 and 40 nm

Showing/Hiding Flight IDs on the Traffic Map Page:

On the Traffic Map Page, press the **FLT ID** Softkey.

Or:

- 1) Press the **MENU** Key.
- 2) If necessary, turn the small **FMS** Knob to select 'Show Flight IDs' or 'Hide Flight IDs' (choice dependent on current state.)
- 3) Press the **ENT** Key.

The Traffic Map Page displays the following information:

- Current aircraft location
- Surrounding traffic
- Range marking rings
- Current traffic mode
 - OPERATING
 - FAIL
- Traffic alert messages
 - FAILED
 - DATA FAILED
 - NO DATA
 - UNAVAILABLE

SYSTEM
OVERVIEW

FLIGHT
INSTRUMENTS

EIS

AUDIO PANEL
& CNS

FLIGHT
MANAGEMENT

**HAZARD
AVOIDANCE**

AFCS

ADDITIONAL
FEATURES

APPENDICES

INDEX

BLANK PAGE

SECTION 7 AUTOMATIC FLIGHT CONTROL SYSTEM



NOTE: The approved Pilot's Operating Handbook (POH) always supersedes the information in this Pilot's Guide.



NOTE: A failure of the primary (#1) GIA 63/63W Integrated Avionics Unit (IAU) results in loss of the flight director. Any IAU failure results in loss of the autopilot and manual electric trim.



NOTE: The GFC 700 is not available for the Cessna 172R.

The GFC 700 is a digital Automatic Flight Control System (AFCS), fully integrated within the System avionics architecture. The System Overview section provides a block diagram to support this system description. GFC 700 AFCS functionality in the Cessna NAV III aircraft is distributed across the following Line Replaceable Units (LRUs):

- GDU 1044B Primary Flight Display (PFD)
- GDU 1044B Multi-Function Display (MFD)
- GIA 63/63W Integrated Avionics Units (2)
- GSA 81 AFCS Servos (3)
- GSM 85 Servo Mounts (3)

The GFC 700 AFCS can be divided into these main operating functions:

- **Flight Director (FD)** — Flight director operation takes place within the primary (#1) IAU. Flight director commands are displayed on the PFD. The flight director provides:
 - Command Bars showing pitch/roll guidance
 - Pitch/roll mode selection and processing
 - Autopilot communication
- **Autopilot (AP)** — Autopilot operation occurs within the pitch, roll and pitch trim servo and provides servo monitoring and automatic flight control in response to flight director steering commands, AHRS attitude and rate information, and airspeed.
- **Manual Electric Trim (MET)** — The pitch trim adapter provides manual electric trim capability when the autopilot is not engaged.

7.1 AFCS CONTROLS

The following dedicated AFCS keys are located on the bezels of the PFD and MFD:

- ① **AP Key** Engages/disengages the autopilot
- ② **HDG Key** Selects/deselects Heading Select Mode
- ③ **NAV Key** Selects/deselects Navigation Mode
- ④ **APR Key** Selects/deselects Approach Mode
- ⑤ **VS Key** Selects/deselects Vertical Speed Mode
- ⑥ **FLC Key** Selects/deselects Flight Level Change Mode
- ⑦ **FD Key** Activates/deactivates the flight director only
 Pressing once turns on the flight director in the default pitch and roll modes. Pressing again deactivates the flight director and removes the Command Bars. If the autopilot is engaged, the key is disabled.
- ⑧ **ALT Key** Selects/deselects Altitude Hold Mode
- ⑨ **VNV Key** Selects/deselects Vertical Path Tracking Mode for Vertical Navigation flight control
- ⑩ **BC Key** Selects/deselects Backcourse Mode
- ⑪ **NOSE UP/NOSE DN Keys** Control the mode reference in Pitch Hold, Vertical Speed, and Flight Level Change modes

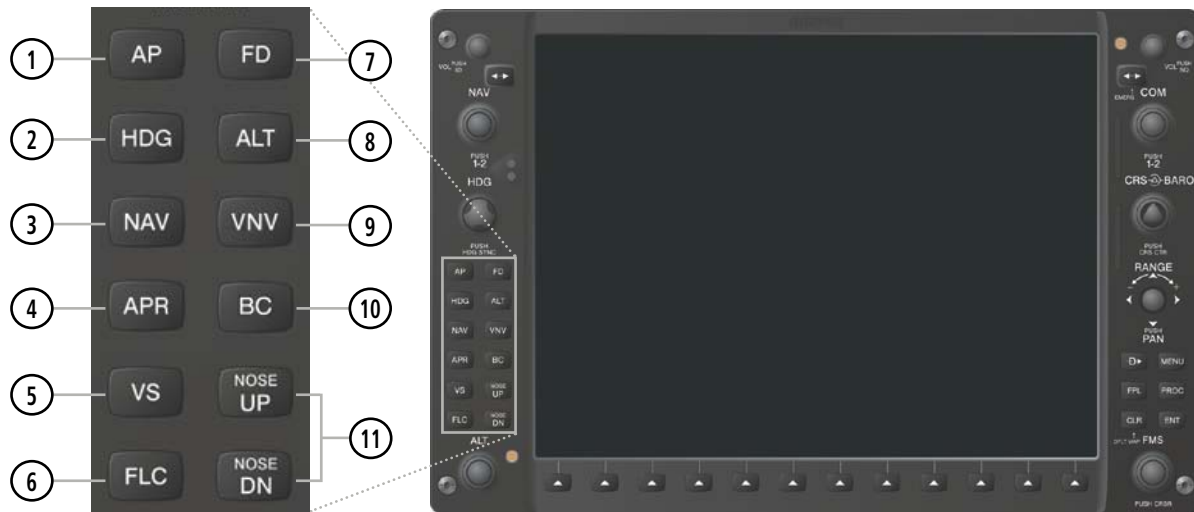

Figure 7-1 Dedicated AFCS Controls

The following AFCS controls are located in the cockpit separately from the PFD and MFD:

**AP DISC Switch
(Autopilot Disconnect)**

Disengages the autopilot and interrupts pitch trim operation

The **AP DISC** Switch is located on the pilot's control wheel.

This switch may be used to mute the aural autopilot disconnect alert.

**CWS Button
(Control Wheel Steering)**

While pressed, allows manual control of the aircraft while the autopilot is engaged and synchronizes the flight director's Command Bars with the current aircraft pitch (if not in Glideslope Mode) and roll (if in Roll Hold Mode)

Upon release of the **CWS** Button, the flight director may establish new reference points, depending on the current pitch and roll modes. CWS operation details are discussed in the flight director modes section.

The **CWS** Button is located on the pilot's control wheel.

GA Switch (Go Around)

Disengages the autopilot and selects flight director Go Around Mode

If an approach procedure is loaded this switch also activates the missed approach when the selected navigation source is GPS or when the navigation source is VOR/LOC and a valid frequency has been tuned.

The **GA** Switch is located on the instrument panel above the throttle.

MET Switch

(Manual Electric Trim)

Used to command manual electric trim

This composite switch is split into left and right sides. The left switch is the ARM contact and the right switch controls the DN (forward) and UP (rearward) contacts. The **MET** ARM Switch can be used to disengage the autopilot and to acknowledge an autopilot disconnect alert and mute the associated aural tone.

Manual trim commands are generated only when both sides of the switch are operated simultaneously. If either side of the switch is active separately for more than three seconds, MET function is disabled and 'PTRM' is displayed as the AFCS Status Annunciation on the PFD. The function remains disabled until both sides of the switch are inactivated.

The **MET** Switch is located on the pilot's control wheel.

7.2 FLIGHT DIRECTOR OPERATION

The flight director function provides pitch and roll commands to the AFCS and displays them on the PFD. With the flight director activated, the aircraft can be hand-flown to follow the path shown by the Command Bars. Maximum commanded pitch (+20°/-15°) and roll (22°) angles, vertical acceleration, and roll rate are limited to values established during AFCS certification. The flight director also provides commands to the autopilot.

ACTIVATING THE FLIGHT DIRECTOR

An initial press of a key listed in Table 7-1 (when the flight director is not active) activates the flight director in the listed modes. The flight director may be turned off and the Command Bars removed from the display by pressing the **FD** Key again. The **FD** Key is disabled when the autopilot is engaged.

Control Pressed	Modes Selected			
	Lateral		Vertical	
FD Key	Roll Hold (default)	ROL	Pitch Hold (default)	PIT
AP Key	Roll Hold (default)	ROL	Pitch Hold (default)	PIT
CWS Button	Roll Hold (default)	ROL	Pitch Hold (default)	PIT
GA Switch	Takeoff (on ground) Go Around (in air)	TO GA	Takeoff (on ground) Go Around (in air)	TO GA
ALT Key	Roll Hold (default)	ROL	Altitude Hold	ALT
VS Key	Roll Hold (default)	ROL	Vertical Speed	VS
VNV Key	Roll Hold (default)	ROL	Vertical Path Tracking*	VPTH
NAV Key	Navigation**	GPS VOR LOC	Pitch Hold (default)	PIT
BC Key	Backcourse***	BC	Pitch Hold (default)	PIT
APR Key	Approach**	GPS VOR LOC	Pitch Hold (default)	PIT
HDG Key	Heading Select	HDG	Pitch Hold (default)	PIT

*Valid VNV flight plan must be entered before **VNV** Key press activates flight director.

The selected navigation receiver must have a valid VOR or LOC signal or active GPS course before **NAV or **APR** Key press activates flight director.

***The selected navigation receiver must have a valid LOC signal before **BC** Key press activates flight director.

Table 7-1 Flight Director Activation

AFCS STATUS BOX

Flight director mode annunciations are displayed on the PFD when the flight director is active. Autopilot status is displayed in the center of the AFCS Status Box. Lateral flight director modes are displayed on the left and vertical on the right. Armed modes are displayed in white and active in green.

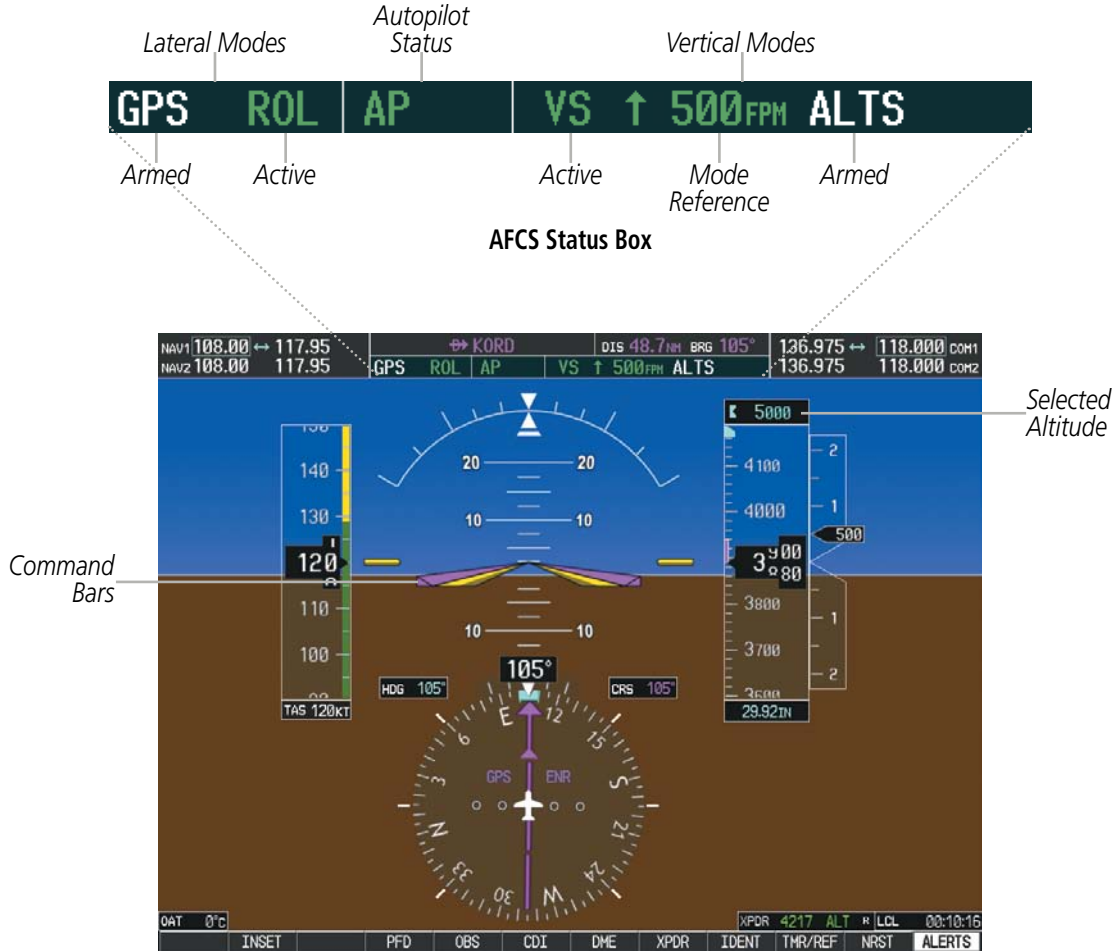

Figure 7-2 PFD AFCS Display

COMMAND BARS

Upon activation of the flight director, Command Bars are displayed on the PFD as a single magenta cue. The Command Bars move together vertically to indicate pitch commands, and bank left or right to indicate roll commands. The Command Bars do not override the aircraft symbol.

If the attitude information sent to the flight director becomes invalid or unavailable, the Command Bars are removed from the display. The flight director Command Bars also disappear if the pitch exceeds +30°/-20° or bank exceeds 65°.

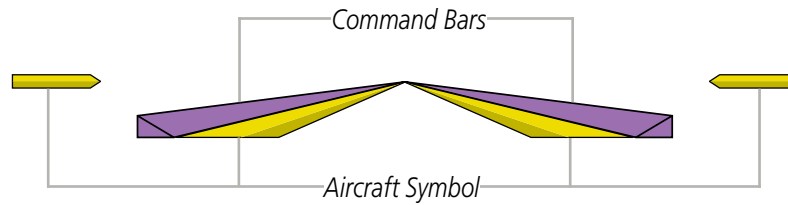

Figure 7-3 Command Bars

FLIGHT DIRECTOR MODES

Flight director modes are normally selected independently for the pitch and roll axes. Unless otherwise specified, all mode keys are alternate action (i.e., press on, press off). In the absence of specific mode selection, the flight director reverts to the default pitch and/or roll modes(s).

Armed modes are annunciated in white and active in green in the AFCS Status Box. Under normal operation when the control for the active flight director mode is pressed, the flight director reverts to the default modes(s) for the axis(es). Automatic transition from armed to active mode is indicated by the white armed mode annunciation moving to the green active mode field and flashing for 10 seconds.

If the information required to compute a flight director mode becomes invalid or unavailable, the flight director automatically reverts to the default mode for that axis. A flashing yellow mode annunciation and annunciator light indicate loss of sensor (ADC) or navigation data (VOR, LOC, GPS, SBAS) required to compute commands. When such a loss occurs, the system automatically begins to roll the wings level (enters Roll Hold Mode) or maintain the pitch angle (enters Pitch Hold Mode), depending on the affected axis. The flashing annunciation stops when the affected mode key is pressed or another mode for the axis is selected. If after 10 seconds no action is taken, the flashing annunciation stops.



Figure 7-4 Loss of VOR Signal

The flight director is automatically disabled if the attitude information required to compute the default flight director modes becomes invalid or unavailable.

7.3 VERTICAL MODES

Table 7-2 lists the vertical modes with their corresponding controls and annunciations. The mode reference is displayed next to the active mode annunciation for Altitude Hold, Vertical Speed, and Flight Level Change modes. The **NOSE UP/NOSE DN** Keys can be used to change the vertical mode reference while operating under Pitch Hold, Vertical Speed, or Flight Level Change Mode. Increments of change and acceptable ranges of values for each of these references using the **NOSE UP/NOSE DN** Keys are also listed in the table.

Vertical Mode	Description	Control	Annunciation	Reference Range	Reference Change Increment
Pitch Hold	Holds aircraft pitch attitude; may be used to climb/descend to the Selected Altitude	(default)	PIT	-15° to +20°	0.5°
Selected Altitude Capture	Captures the Selected Altitude	*	ALTS		
Altitude Hold	Holds current Altitude Reference	ALT Key	ALT nnnnn FT		
Vertical Speed	Holds aircraft vertical speed; may be used to climb/descend to the Selected Altitude	VS Key	VS nnnn FPM	-2000 to +1500 fpm	100 fpm
Flight Level Change	Holds aircraft airspeed while aircraft is climbing/descending to the Selected Altitude	FLC Key	FLC nnn KT	80 to 200 kts (350) 80 to 210 kts (400)	1 kt
Vertical Path Tracking	Captures and tracks descent legs of an active vertical profile	VNV Key	VPTH		
VNV Target Altitude Capture	Captures the Vertical Navigation (VNV) Target Altitude	**	ALTV		
Glidepath***	Captures and tracks the SBAS glidepath on approach	APR Key	GP		
Glideslope	Captures and tracks the ILS glideslope on approach		GS		
Go Around	Disengages the autopilot and commands a constant pitch angle and wings level	GA Switch	GA	7°	

* *ALTS is armed automatically when PIT, VS, FLC, or GA is active, and under VPTH when the Selected Altitude is to be captured instead of the VNV Target Altitude.*

** *ALTV is armed automatically under VPTH when the VNV Target Altitude is to be captured instead of the Selected Altitude.*

*** *GP is available in installations with GIA 63W IAUs when SBAS is available.*

Table 7-2 Flight Director Vertical Modes

PITCH HOLD MODE (PIT)

When the flight director is activated (the **FD** Key is pressed), Pitch Hold Mode is selected by default. Pitch Hold Mode is indicated as the active pitch mode by the green annunciation 'PIT'. This mode may be used for climb or descent to the Selected Altitude (shown above the Altimeter), since Selected Altitude Capture Mode is automatically armed when Pitch Hold Mode is activated.

In Pitch Hold Mode, the flight director maintains a constant pitch attitude, the pitch reference. The pitch reference is set to the aircraft pitch attitude at the moment of mode selection. If the aircraft pitch attitude exceeds the flight director pitch command limitations, the flight director commands a pitch angle equal to the nose-up/down limit.

CHANGING THE PITCH REFERENCE

When operating in Pitch Hold Mode, the pitch reference can be adjusted by:

- Using the **NOSE UP/NOSE DN** Keys
- By pressing the **CWS** Button, hand-flying the aircraft to establish a new pitch reference, then releasing the **CWS** Button

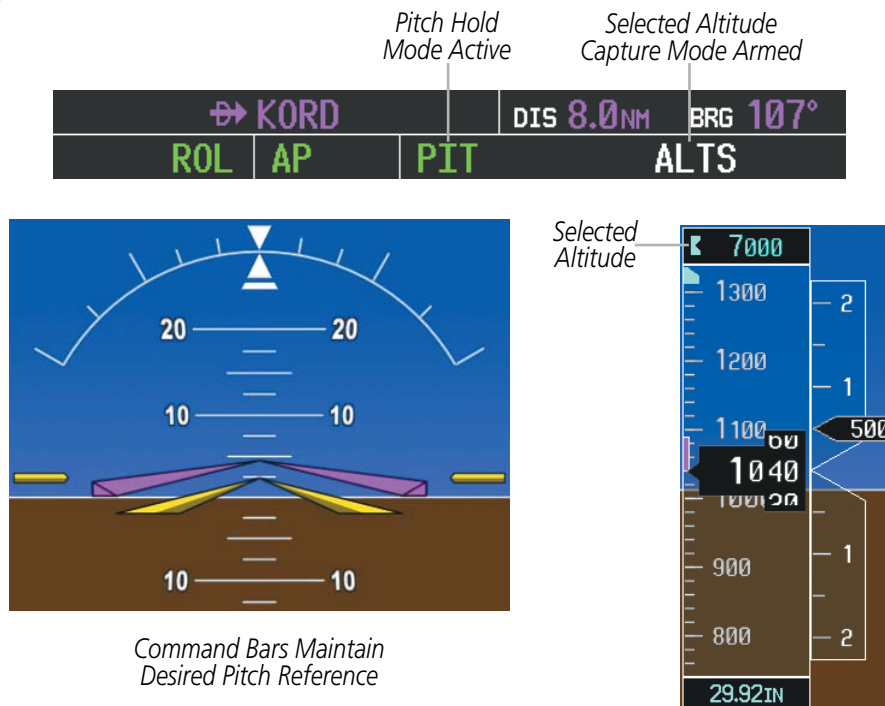

Figure 7-5 Pitch Hold Mode

SELECTED ALTITUDE CAPTURE MODE (ALTS)

Selected Altitude Capture Mode is automatically armed with activation of the following modes:

- Pitch Hold
- Vertical Speed
- Flight Level Change
- Go Around
- Vertical Path Tracking (if the Selected Altitude is to be captured instead of the VNV Target Altitude)

The white 'ALTS' annunciation indicates Selected Altitude Capture Mode is armed (see Figure 7-5 for example). The **ALT** Knob is used to set the Selected Altitude (shown above the Altimeter) until Selected Altitude Capture Mode becomes active.

As the aircraft nears the Selected Altitude, the flight director automatically transitions to Selected Altitude Capture Mode with Altitude Hold Mode armed (Figure 7-6). This automatic transition is indicated by the green 'ALTS' annunciation flashing for up to 10 seconds and the appearance of the white 'ALT' annunciation. The Selected Altitude is shown as the Altitude Reference beside the 'ALTS' annunciation.

At 50 feet from the Selected Altitude, the flight director automatically transitions from Selected Altitude Capture to Altitude Hold Mode and holds the Selected Altitude (shown as the Altitude Reference). As Altitude Hold Mode becomes active, the white 'ALT' annunciation moves to the active pitch mode field and flashes green for 10 seconds to indicate the automatic transition.

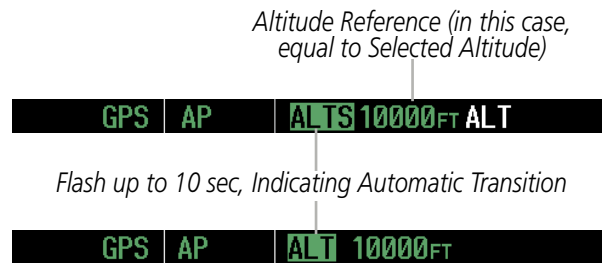

Figure 7-6 Automatic Mode Transitions During Altitude Capture

CHANGING THE SELECTED ALTITUDE



NOTE: Pressing the **CWS** Button while in Selected Altitude Capture Mode does not cancel the mode.

Use of the **ALT** Knob to change the Selected Altitude while Selected Altitude Capture Mode is active causes the flight director to revert to Pitch Hold Mode with Selected Altitude Capture Mode armed for the new Selected Altitude.

ALTITUDE HOLD MODE (ALT)

Altitude Hold Mode can be activated by pressing the **ALT** Key; the flight director maintains the current aircraft altitude (to the nearest 10 feet) as the Altitude Reference. The flight director's Altitude Reference, shown in the AFCS Status Box, is independent of the Selected Altitude, displayed above the Altimeter. Altitude Hold Mode active is indicated by a green 'ALT' annunciation in the AFCS Status Box.

Altitude Hold Mode is automatically armed when the flight director is in Selected Altitude Capture Mode (see Figure 7-6). Selected Altitude Capture Mode automatically transitions to Altitude Hold Mode when the altitude error is less than 50 feet. In this case, the Selected Altitude becomes the flight director's Altitude Reference.

CHANGING THE ALTITUDE REFERENCE



NOTE: Turning the **ALT** Knob while in Altitude Hold Mode changes the Selected Altitude, but not the flight director's Altitude Reference, and does not cancel the mode.

With the **CWS** Button depressed, the aircraft can be hand-flown to a new Altitude Reference. When the **CWS** Button is released at the desired altitude, the new altitude is established as the Altitude Reference.

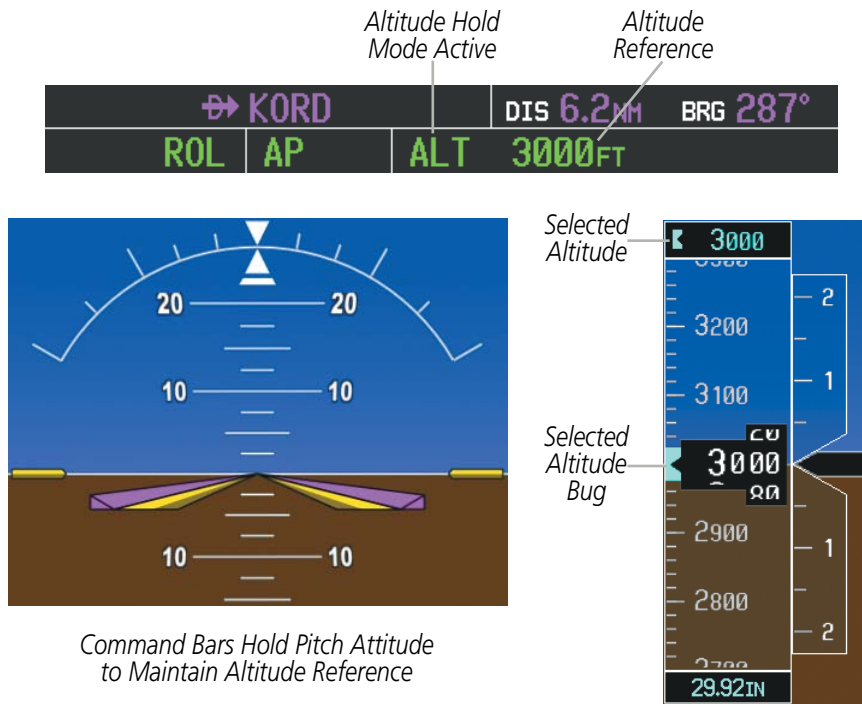

Figure 7-7 Altitude Hold Mode

VERTICAL SPEED MODE (VS)

In Vertical Speed Mode, the flight director acquires and maintains a Vertical Speed Reference. Current aircraft vertical speed (to the nearest 100 fpm) becomes the Vertical Speed Reference at the moment of Vertical Speed Mode activation. This mode may be used for climb or descent to the Selected Altitude (shown above the Altimeter) since Selected Altitude Capture Mode is automatically armed when Vertical Speed Mode is selected.

When Vertical Speed Mode is activated by pressing the **VS** Key, 'VS' is annunciated in green in the AFCS Status Box along with the Vertical Speed Reference. The Vertical Speed Reference is also displayed above the Vertical Speed Indicator. A Vertical Speed Reference Bug corresponding to the Vertical Speed Reference is shown on the indicator.

CHANGING THE VERTICAL SPEED REFERENCE

The Vertical Speed Reference (shown both in the AFCS Status Box and above/below the Vertical Speed Indicator) may be changed:

- Using the **NOSE UP/NOSE DN** Keys
- By pressing the **CWS** Button, hand-flying the aircraft to a new Vertical Speed Reference, then releasing the **CWS** Button



NOTE: If the Selected Altitude is reached during CWS maneuvering, the Altitude Reference is not changed. To adjust the Altitude Reference in this case, the CWS Button must be pressed again after the Selected Altitude is reached.

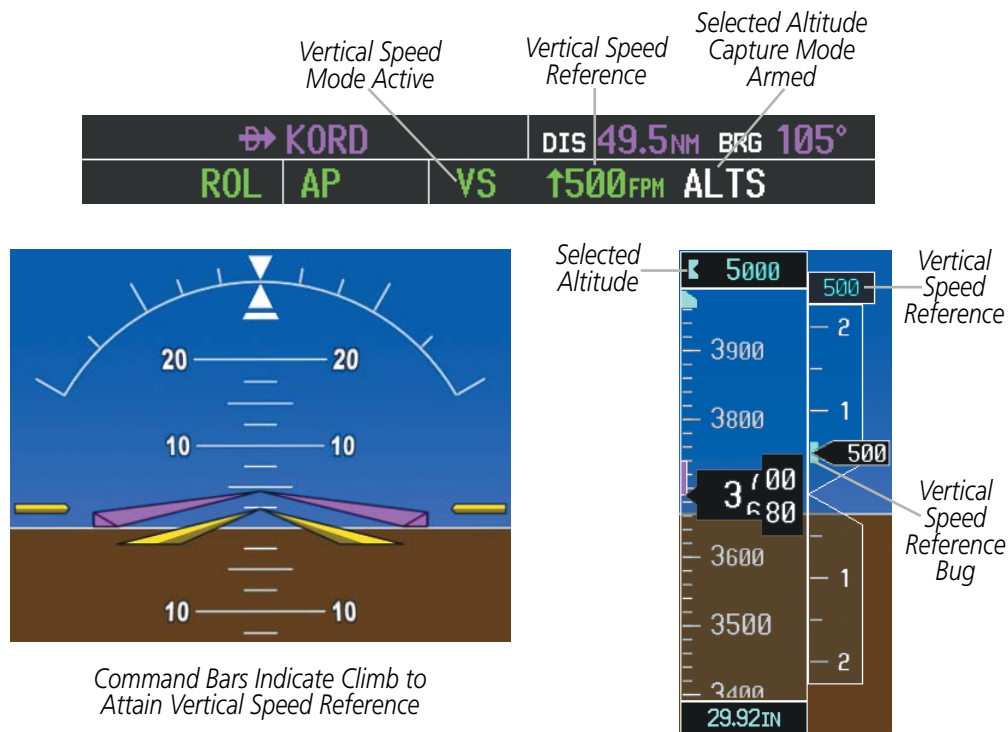

Figure 7-8 Vertical Speed Mode

FLIGHT LEVEL CHANGE MODE (FLC)



NOTE: *The Selected Altitude should be set before engaging Flight Level Change Mode.*

Flight Level Change Mode is selected by pressing the **FLC** Key. This mode acquires and maintains the Airspeed Reference while climbing or descending to the Selected Altitude (shown above the Altimeter). When Flight Level Change Mode is active, the flight director continuously monitors Selected Altitude, airspeed, and altitude.

The Airspeed Reference is set to the current airspeed upon mode activation. Flight Level Change Mode is indicated by an 'FLC' annunciation beside the Airspeed Reference in the AFCS Status Box. The Airspeed Reference is also displayed directly above the Airspeed Indicator, along with a bug corresponding to the Airspeed Reference along the tape.

Engine power must be adjusted to allow the autopilot to fly the aircraft at a pitch attitude corresponding to the desired flight profile (climb or descent) while maintaining the Airspeed Reference. The flight director maintains the current altitude until either engine power or the Airspeed Reference are adjusted and does not allow the aircraft to climb or descend away from the Selected Altitude.

CHANGING THE AIRSPEED REFERENCE

The Airspeed Reference (shown in both the AFCS Status Box and above the Airspeed Indicator) may be adjusted by:

- Using the **NOSE UP/NOSE DN** Keys
- Pressing the **CWS** Button, hand-flying the aircraft to a new airspeed, then releasing the **CWS** Button to establish the new Airspeed Reference



NOTE: *If the Selected Altitude is reached during CWS maneuvering, the Airspeed Reference is not changed. To adjust the Airspeed Reference in this case, the CWS Button must be pressed again after the Selected Altitude is reached.*

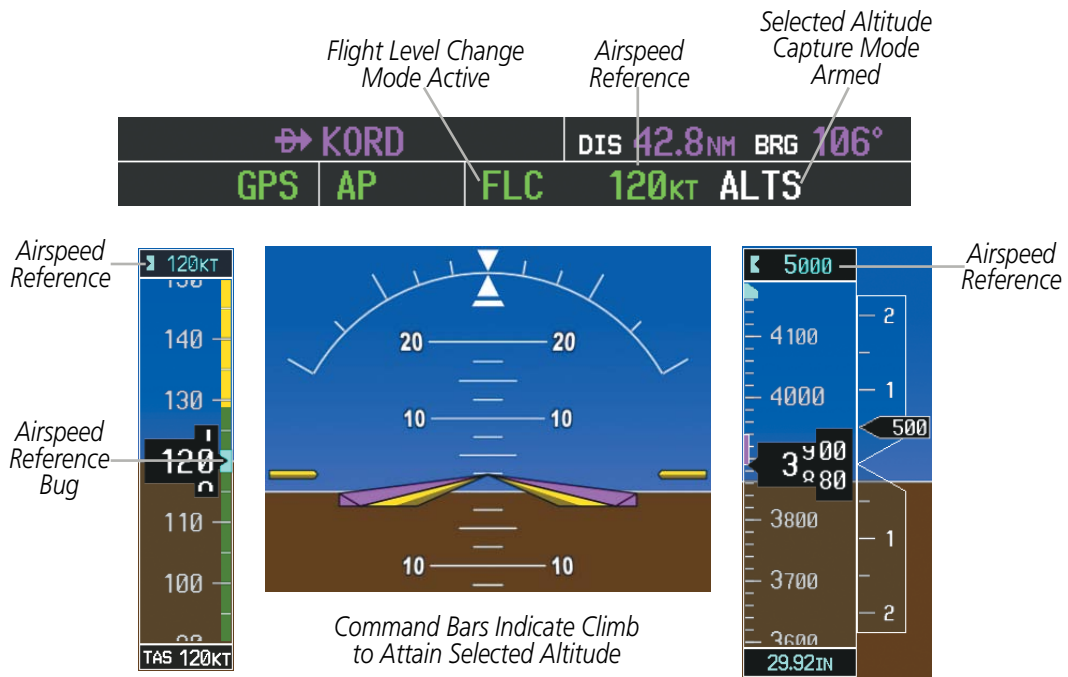

Figure 7-9 Flight Level Change Mode

VERTICAL NAVIGATION MODES (VPTH, ALTV)

NOTE: VNV is disabled when parallel track or dead reckoning mode is active.

NOTE: The Selected Altitude takes precedence over any other vertical constraints.

Vertical Navigation (VNV) flight control is available for enroute/terminal cruise and descent operations any time that VNV flight planning is available. Refer to the Flight Management Section for more information on VNV flight plans. Conditions for availability include, but are not limited to:

- The selected navigation source is GPS.
- A VNV flight plan (with at least one altitude-constrained waypoint) or vertical direct-to is active.
- VNV is enabled (**VNV ENBL** Softkey pressed on the MFD).
- Crosstrack error is valid and within certain limits.
- Desired/actual track are valid or track angle error is within certain limits.
- The VNV Target Altitude of the active waypoint is no more than 250 ft above the current aircraft altitude.

The flight director may be armed for VNV at any time, but no target altitudes are captured during a climb. The Command Bars provide vertical profile guidance based on specified altitudes (entered manually or loaded from the database) at waypoints in the active flight plan or vertical direct-to. The appropriate VNV flight control modes are sequenced by the flight director to follow the path defined by the vertical profile. Upon reaching the last waypoint in the VNV flight plan, the flight director transitions to Altitude Hold Mode and cancels any armed VNV modes.

VERTICAL PATH TRACKING MODE (VPTH)

NOTE: If another pitch mode key is pressed while Vertical Path Tracking Mode is selected, Vertical Path Tracking Mode reverts to armed.

NOTE: Pressing the **CWS** Button while Vertical Path Tracking Mode is active does not cancel the mode. The autopilot guides the aircraft back to the descent path upon release of the **CWS** Button.

When a vertical profile (VNV flight plan) is active and the **VNV** Key is pressed, Vertical Path Tracking Mode is armed in preparation for descent path capture. 'VPTH' (or 'V' when Glidepath or Glideslope Mode is concurrently armed) is annunciated in white in addition to previously armed modes. If applicable, the appropriate altitude capture mode is armed for capture of the next VNV Target Altitude (ALTV) or the Selected Altitude (ALTS), whichever is greater.



Figure 7-10 Vertical Path Tracking Armed Annunciations

Prior to descent path interception, the Selected Altitude must be set below the current aircraft altitude by at least 75 feet. For the flight director to transition from Altitude Hold to Vertical Path Tracking Mode, acknowledgment is required within 5 minutes of descent path interception by:

- Pressing the **VNV** Key
- Adjusting the Selected Altitude

If acknowledgment is not received within 1 minute of descent path interception, the white 'VPTH' annunciation starts to flash. Flashing continues until acknowledged or the descent path is intercepted. If the descent is not confirmed by the time of interception, Vertical Path Tracking Mode remains armed and the descent is not captured.

In conjunction with the "TOD [top of descent] within 1 minute" annunciation in the Navigation Status Box and the "Vertical Track" voice message, VNV indications (VNV Target Altitude, vertical deviation, and vertical speed required) appear on the PFD in magenta (Figure 7-11).

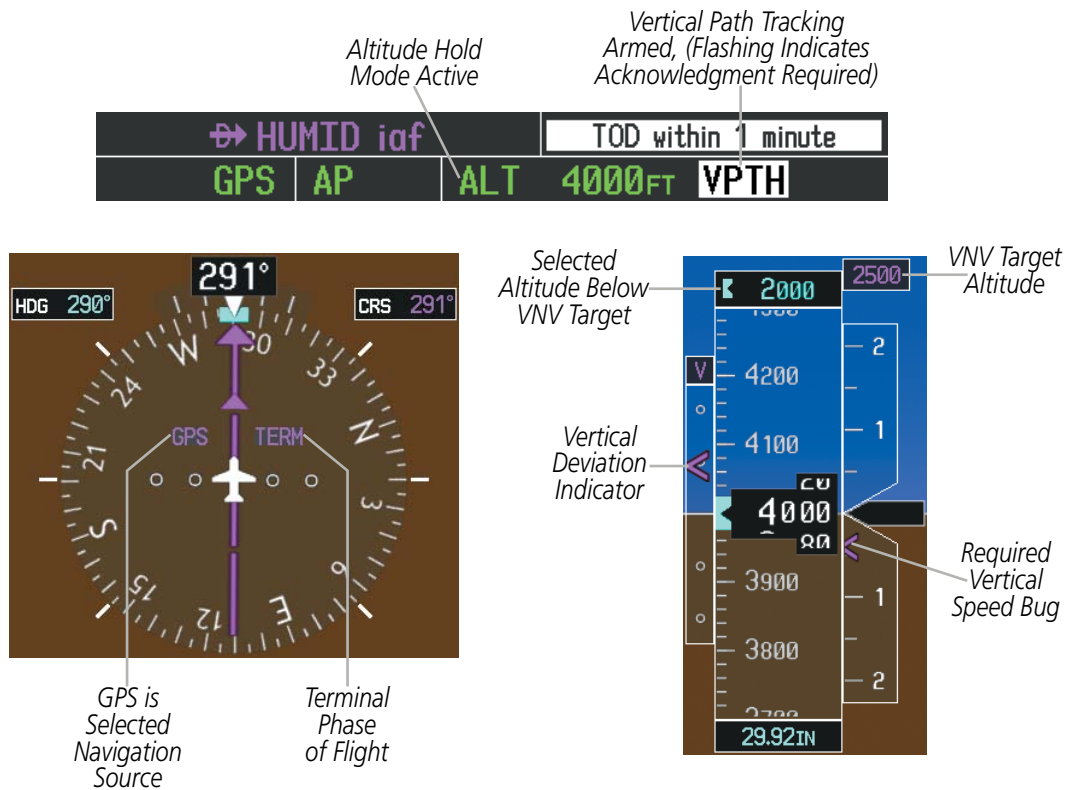

Figure 7-11 Vertical Path Capture

When a descent leg is captured (i.e., vertical deviation becomes valid), Vertical Path Tracking becomes active and tracks the descent profile (Figure 7-12). An altitude capture mode ('ALTS' or 'ALTV') is armed as appropriate.



Figure 7-12 Vertical Path Tracking Mode

If the Altimeter's barometric setting is adjusted while Vertical Path Tracking is active, the flight director increases/decreases the descent rate by up to 500 fpm to re-establish the aircraft on the descent path (without commanding a climb). Adjusting the altimeter barometric setting creates discontinuities in VNV vertical deviation, moving the descent path. For large adjustments, it may take several minutes for the aircraft to re-establish on the descent path. If the change is made while nearing a waypoint with a VNV Target Altitude, the aircraft may not re-establish on the descent path in time to meet the vertical constraint.

- SYSTEM OVERVIEW
- FLIGHT INSTRUMENTS
- EIS
- AUDIO PANEL & CNS
- FLIGHT MANAGEMENT
- HAZARD AVOIDANCE
- AFCS
- ADDITIONAL FEATURES
- APPENDICES
- INDEX

AUTOMATIC REVERSION TO PITCH HOLD MODE

Several situations can occur while Vertical Path Tracking Mode is active which cause the flight director to revert to Pitch Hold Mode:

- Vertical deviation exceeds 200 feet during an overspeed condition.
- Vertical deviation experiences a discontinuity that both exceeds 200 feet in magnitude and results in the vertical deviation exceeding 200 feet in magnitude. Such discontinuities are usually caused by flight plan changes that affect the vertical profile.
- Vertical deviation becomes invalid (the Vertical Deviation Indicator is removed from the PFD).
- A display enters Reversionary Mode (this does not apply to an active vertical direct-to).

Unless VNV is disabled, Vertical Path Tracking Mode and the appropriate altitude capture mode become armed following the reversion to Pitch Hold Mode to allow for possible profile recapture.

NON-PATH DESCENTS

Pitch Hold, Vertical Speed, and Flight Level Change modes can also be used to fly non-path descents while VNV flight control is selected. If the **VS** or **FLC** Key is pressed while Vertical Path Tracking Mode is selected, Vertical Path Tracking Mode reverts to armed along with the appropriate altitude capture mode to allow profile re-capture.



Figure 7-13 Flight Level Change VNV Non-Path Descent

To prevent immediate profile re-capture, the following must be satisfied:

- At least 10 seconds have passed since the non-path transition was initiated
 - Vertical deviation from the profile has exceeded 250 feet, but is now less than 200 feet
- Pressing the **VNV** Key twice re-arms Vertical Path Tracking for immediate profile re-capture.

VNV TARGET ALTITUDE CAPTURE MODE (ALTV)



NOTE: Armed VNV Target Altitude and Selected Altitude capture modes are mutually exclusive. However, Selected Altitude Capture Mode is armed implicitly (not annunciated) whenever VNV Target Altitude Capture Mode is armed.

VNV Target Altitude Capture is analogous to Selected Altitude Capture Mode and is armed automatically after the **VNV** Key is pressed and the next VNV Target Altitude is to be intercepted before the Selected Altitude. The annunciation ‘ALTV’ indicates that the VNV Target Altitude is to be captured. VNV Target Altitudes are shown in the active flight plan or vertical direct-to, and can be entered manually or loaded from a database (see the Flight Management Section for details). At the same time as “TOD within 1 minute” is annunciated in the Navigation Status Box, the active VNV Target Altitude is displayed above the Vertical Speed Indicator (see Figure 7-11).

As the aircraft nears the VNV Target Altitude, the flight director automatically transitions to VNV Target Altitude Capture Mode with Altitude Hold Mode armed. This automatic transition is indicated by the green ‘ALTV’ annunciation flashing for up to 10 seconds and the appearance of the white ‘ALT’ annunciation. The VNV Target Altitude is shown as the Altitude Reference beside the ‘ALTV’ annunciation and remains displayed above the Vertical Speed Indicator. The Required Vertical Speed Indication (RSVI) is removed once VNV Target Altitude Capture Mode becomes active.

At 50 feet from the VNV Target Altitude, the flight director automatically transitions from VNV Target Altitude Capture to Altitude Hold Mode and tracks the level leg. As Altitude Hold Mode becomes active, the white ‘ALT’ annunciation moves to the active vertical mode field and flashes green for 10 seconds to indicate the automatic transition. The flight director automatically arms Vertical Path Tracking, allowing upcoming descent legs to be captured and subsequently tracked.

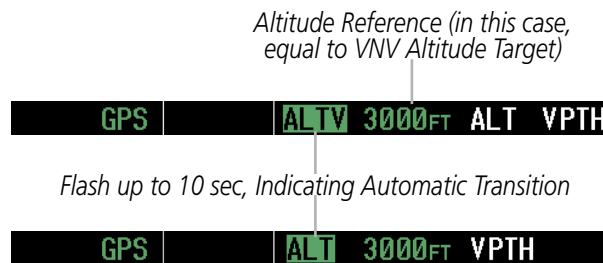

Figure 7-14 Automatic Mode Transitions During Altitude Capture

CHANGING THE VNV TARGET ALTITUDE



NOTE: Pressing the **CWS** Button while in VNV Target Altitude Capture Mode does not cancel the mode.

Changing the current VNV Target Altitude while VNV Target Altitude Capture Mode is active causes the flight director to revert to Pitch Hold Mode. Vertical Path Tracking and the appropriate altitude capture mode are armed in preparation to capture the new VNV Target Altitude or the Selected Altitude, depending on which altitude is to be intercepted first.

VNV target altitudes can be changed while editing the active flight plan (see the Flight Management Section for details).

SYSTEM OVERVIEW

FLIGHT INSTRUMENTS

EIS

AUDIO PANEL & CNS

FLIGHT MANAGEMENT

HAZARD AVOIDANCE

AFCS

ADDITIONAL FEATURES

APPENDICES

INDEX

GLIDEPATH MODE (GP) (SBAS ONLY)

 **NOTE:** Pressing the **CWS** Button while Glidepath Mode is active does not cancel the mode. The autopilot guides the aircraft back to the glidepath upon release of the **CWS** Button.

Glidepath Mode is available only in installations with GIA 63W IAUs when SBAS is available. Glidepath Mode is used to track the SBAS-based glidepath. When Glidepath Mode is armed, 'GP' is annunciated in white in the AFCS Status Box.

Selecting Glidepath Mode:

- 1) Ensure a GPS approach with vertical guidance (LPV, LNAV/VNAV, LNAV+V) is loaded into the active flight plan. The active waypoint must be part of the flight plan (cannot be a direct-to a waypoint not in the flight plan).
- 2) Ensure that GPS is the selected navigation source (use the **CDI** Softkey to cycle through navigation sources).
- 3) Press the **APR** Key.

 **NOTE:** Some RNAV (GPS) approaches provide a vertical descent angle as an aid in flying a stabilized approach. These approaches are NOT considered Approaches with Vertical Guidance (APV). Approaches that are annunciated on the HSI as LNAV or LNAV+V are considered Nonprecision Approaches (NPA) and are flown to an MDA even though vertical glidepath (GP) information may be provided.

 **WARNING:** When flying an LNAV approach (with vertical descent angle) with the autopilot coupled, the aircraft will not level off at the MDA even if the MDA is set in the altitude preselect.

Upon reaching the glidepath, the flight director transitions to Glidepath Mode and begins to capture and track the glidepath.



Figure 7-15 Glidepath Mode Armed

Once the following conditions have been met, the glidepath can be captured:

- The active waypoint is at or after the final approach fix (FAF).
- Vertical deviation is valid.
- The CDI is at less than full scale deviation
- Automatic sequencing of waypoints has not been suspended (no 'SUSP' annunciation on the HSI)

- SYSTEM OVERVIEW
- FLIGHT INSTRUMENTS
- EIS
- AUDIO PANEL & CNS
- FLIGHT MANAGEMENT
- HAZARD AVOIDANCE
- AFCS
- ADDITIONAL FEATURES
- APPENDICES
- INDEX

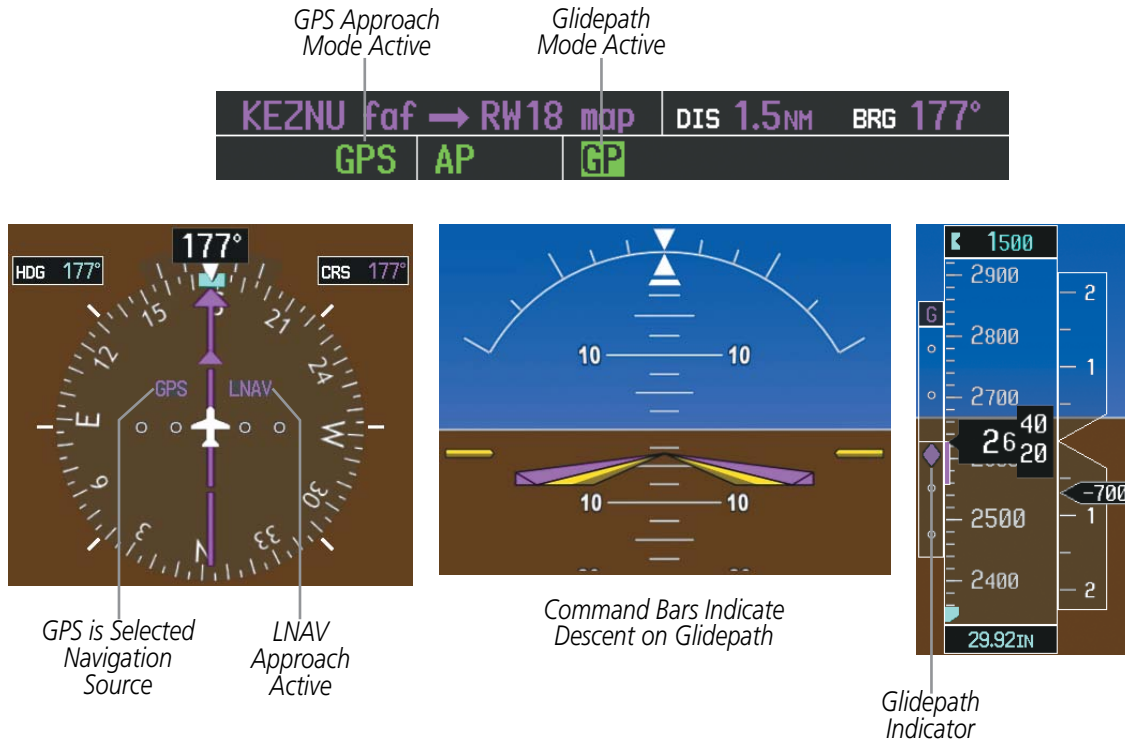

Figure 7-16 Glidepath Mode

GLIDESLOPE MODE (GS)

NOTE: Pressing the **CWS** Button while Glideslope Mode is active does not cancel the mode. The autopilot guides the aircraft back to the glideslope upon release of the **CWS** Button.

Glideslope Mode is available for LOC/ILS approaches to capture and track the glideslope. When Glideslope Mode is armed (annunciated as 'GS' in white), LOC Approach Mode is armed as the lateral flight director mode.

Selecting Glideslope Mode:

- 1) Ensure a valid localizer frequency is tuned.
 - 2) Ensure that LOC is the selected navigation source (use the **CDI** Softkey to cycle through navigation sources).
 - 3) Press the **APR** Key.
- Or:**
- 1) Ensure that GPS is the selected navigation source (use the **CDI** Softkey to cycle through navigation sources).
 - 2) Ensure a LOC/ILS approach is loaded into the active flight plan.
 - 3) Ensure the corresponding LOC frequency is tuned.
 - 4) Press the **APR** Key.



Figure 7-17 Glideslope Mode Armed

Once LOC is the navigation source, the localizer and glideslope can be captured. Upon reaching the glideslope, the flight director transitions to Glideslope Mode and begins to intercept and track the glideslope.

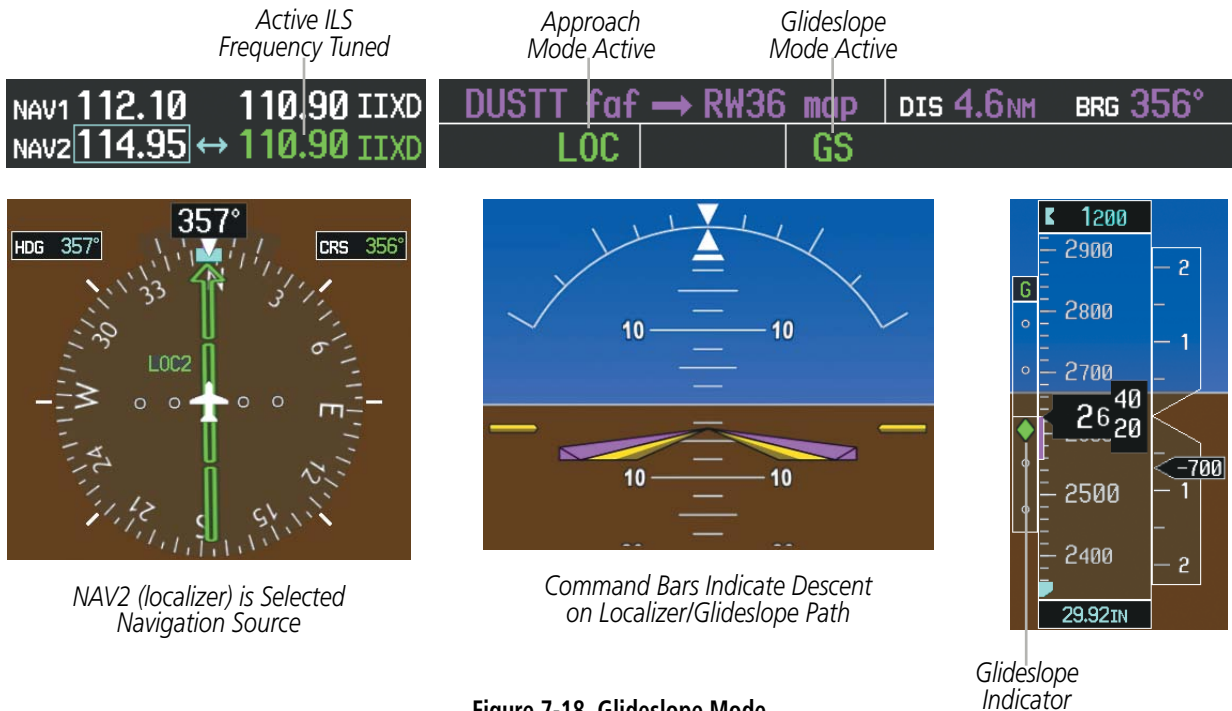

Figure 7-18 Glideslope Mode

SYSTEM OVERVIEW

FLIGHT INSTRUMENTS

EIS

AUDIO PANEL & CNS

FLIGHT MANAGEMENT

HAZARD AVOIDANCE

AFCS

ADDITIONAL FEATURES

APPENDICES

INDEX

GO AROUND MODE (GA)

Pressing the **GA** Switch engages the flight director in a wings-level, pitch-up attitude, allowing the execution of a missed approach or a go around. This mode is a coupled pitch and roll mode and is annunciated as ‘GA’ in both the active pitch and roll mode fields. Go Around Mode disengages the autopilot and arms Selected Altitude Capture Mode automatically. Subsequent autopilot engagement is allowed. Attempts to modify the aircraft attitude (i.e., with the **CWS** Button or **NOSE UP/NOSE DN** Keys) result in reversion to Pitch and Roll Hold modes.



Go Around Mode Active

*Autopilot Disconnect Annunciation
Flashes Yellow 5 sec*

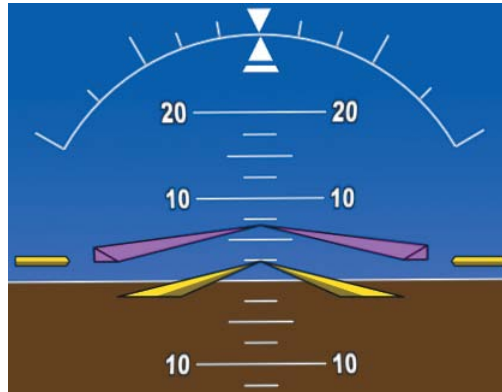

Command Bars Indicate Climb

Figure 7-19 Go Around Mode

7.4 LATERAL MODES

The GFC 700 offers the lateral modes listed in Table 7-3. Refer to the vertical modes section for information regarding Go Around Mode:

Lateral Mode	Description	Control	Annunciation	Maximum Roll Command Limit
Roll Hold	Holds the current aircraft roll attitude or rolls the wings level, depending on the commanded bank angle	(default)	ROL	22°
Heading Select	Captures and tracks the Selected Heading	HDG Key	HDG	22°
Navigation, GPS	Captures and tracks the selected navigation source (GPS, VOR, LOC)	NAV Key	GPS	22°
Navigation, VOR Enroute Capture/Track			VOR	22° Capture 10° Track
Navigation, LOC Capture/Track (No Glideslope)			LOC	22° Capture 10° Track
Navigation, Backcourse Capture/Track			BC	22° Capture 10° Track
Approach, GPS	Captures and tracks the selected navigation source (GPS, VOR, LOC)	APR Key	GPS	22°
Approach, VOR Capture/Track			VAPP	22° Capture 10° Track
Approach, LOC Capture/Track (Glideslope Mode automatically armed)			LOC	22° Capture 10° Track
Go Around	Disengages the autopilot and commands a constant pitch angle and wings level	GA Switch	GA	Wings Level

The GFC 700 may generate a lower bank angle than the maximum roll command limit in degrees indicated in the table above by the amount needed to produce a turn rate equal to or less than standard rate.

Table 7-3 Lateral Modes

The **CWS** Button does not change lateral references for Heading Select, Navigation, Backcourse, or Approach modes. The autopilot guides the aircraft back to the Selected Heading/Course upon release of the **CWS** Button.

ROLL HOLD MODE (ROL)



NOTE: If Roll Hold Mode is activated as a result of a mode reversion, the flight director rolls the wings level.

When the flight director is activated, Roll Hold Mode is selected by default. This mode is annunciated as 'ROL' in the AFCS Status Box. The current aircraft bank angle is held, subject to the bank angle conditions listed in Table 7-4.



Figure 7-20 Roll Hold Mode Annunciation

Bank Angle	Flight Director Response
< 6°	Rolls wings level
6° to 22°	Maintains current aircraft roll attitude
> 22°	Limits bank to 22°

Table 7-4 Roll Hold Mode Responses

CHANGING THE ROLL REFERENCE

The roll reference can be changed by pressing the **CWS** Button, establishing the desired bank angle, then releasing the **CWS** Button.

HEADING SELECT MODE (HDG)

Heading Select Mode is activated by pressing the **HDG** Key. Heading Select Mode acquires and maintains the Selected Heading. The Selected Heading is shown by a light blue bug on the HSI and in the box to the upper left of the HSI.

CHANGING THE SELECTED HEADING

NOTE: Pressing the **HDG** Knob synchronize the Selected Heading to the current heading.

The Selected Heading is adjusted using the **HDG** Knob. Pressing the **CWS** Button and hand-flying the aircraft does not change the Selected Heading. The autopilot guides the aircraft back to the Selected Heading upon release of the **CWS** Button.

Turns are commanded in the same direction as Selected Heading Bug movement, even if the Bug is turned more than 180° from the present heading (e.g., a 270° turn to the right). However, Selected Heading changes of more than 340° at a time result in turn reversals.

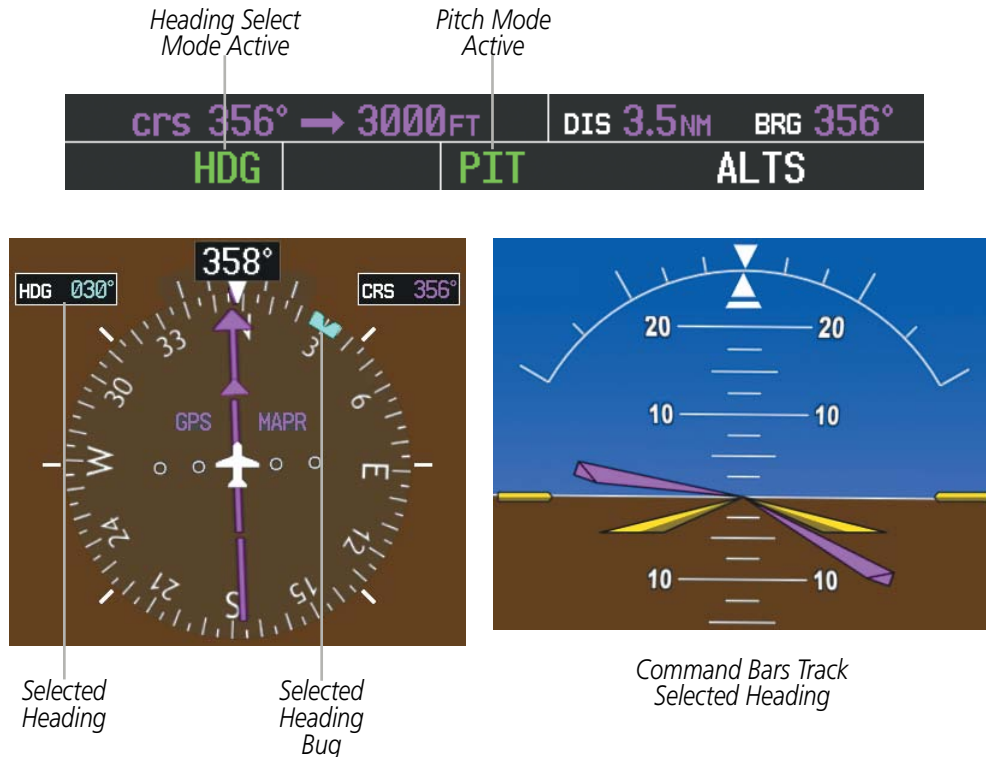



Figure 7-21 Heading Select Mode

NAVIGATION MODES (GPS, VOR, LOC)

 **NOTE:** The selected navigation receiver must have a valid VOR or LOC signal or active GPS course for the flight director to enter Navigation Mode.

 **NOTE:** When intercepting a flight plan leg, the flight director gives commands to capture the active leg at approximately a 45° angle to the track between the waypoints defining the active leg. The flight director does not give commands to fly to the starting waypoint of the active leg.

Pressing the **NAV** Key selects Navigation Mode. Navigation Mode acquires and tracks the selected navigation source (GPS, VOR, LOC). The flight director follows GPS roll steering commands when GPS is the selected navigation source. When the navigation source is VOR or LOC, the flight director creates roll steering commands from the Selected Course and deviation. Navigation Mode can also be used to fly non-precision GPS and LOC approaches where glideslope capture is not required.

If the Course Deviation Indicator (CDI) shows greater than one dot when the **NAV** Key is pressed, the selected mode is armed. If the CDI is less than one dot, Navigation Mode is automatically captured when the **NAV** Key is pressed. The armed annunciation appears in white to the left of the active roll mode.

GPS ROL PIT ALT

Figure 7-22 GPS Navigation Mode Armed

When the CDI has automatically switched from GPS to LOC during a LOC/ILS approach, GPS Navigation Mode remains active, providing GPS steering guidance until the localizer signal is captured. LOC Navigation Mode is armed when the automatic navigation source switch takes place. If the **APR** Key is pressed prior to the automatic navigation source switch, LOC Navigation mode is armed.

If Navigation Mode is active and either of the following occur, the flight director reverts to Roll Hold Mode (wings rolled level):

- Different VOR tuned while in VOR Navigation Mode (VOR Navigation Mode reverts to armed)
- Navigation source manually switched (with the **CDI** Softkey)
- During a LOC/ILS approach the FAF is crossed while in GPS Navigation Mode after the automatic navigation source switch from GPS to LOC

CHANGING THE SELECTED COURSE

The Selected Course is controlled using the **CRS** Knob (while in VOR, LOC, or OBS Mode). Pressing the **CWS** Button and hand-flying the aircraft does not change the Selected Course while in Navigation Mode. The autopilot guides the aircraft back to the Selected Course (or GPS flight plan) when the **CWS** Button is released.

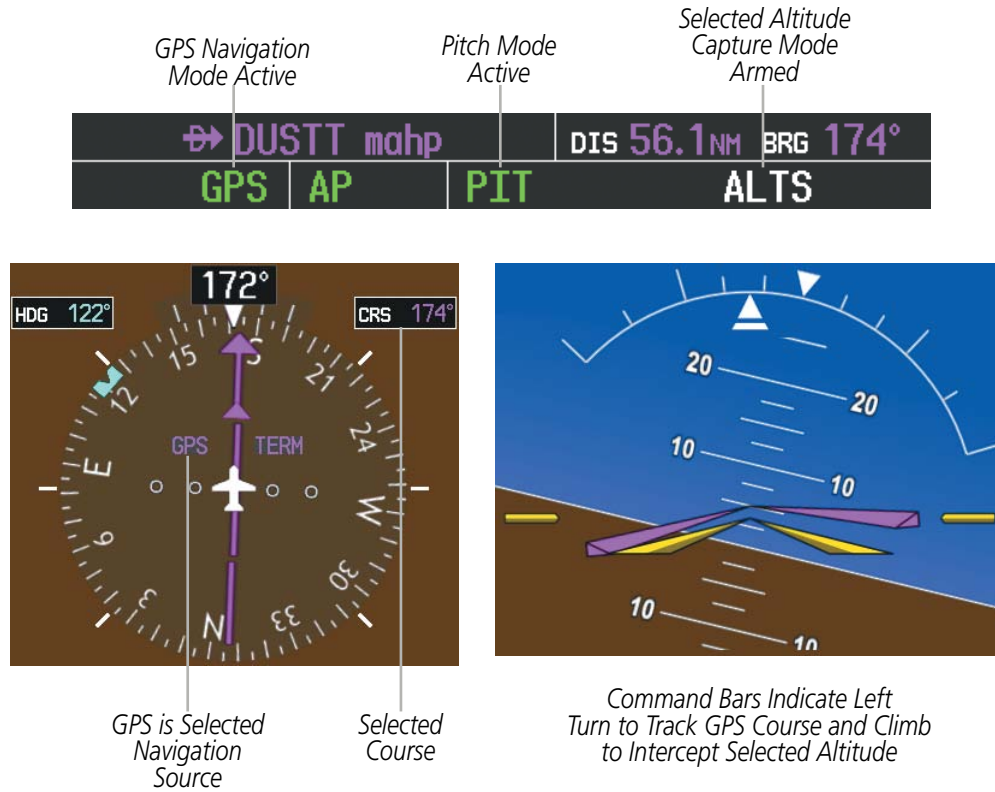

Figure 7-23 Navigation Mode

APPROACH MODES (GPS, VAPP, LOC)



NOTE: The selected navigation receiver must have a valid VOR or LOC signal or active GPS course for the flight director to enter Approach Mode.

Approach Mode is activated when the **APR** Key is pressed. Approach Mode acquires and tracks the selected navigation source (GPS, VOR, or LOC), depending on loaded approach. This mode uses the selected navigation receiver deviation and desired course inputs to fly the approach. Pressing the **APR** Key when the CDI is greater than one dot arms the selected approach mode (annunciated in white to the left of the active lateral mode). If the CDI is less than one dot, the LOC is automatically captured when the **APR** Key is pressed.

VOR Approach Mode (VAPP) provides greater sensitivity for signal tracking than VOR Navigation Mode .

Selecting VOR Approach Mode:

- 1) Ensure a valid VOR frequency is tuned.
- 2) Ensure that VOR is the selected navigation source (use the **CDI** Softkey to cycle through navigation sources if necessary).
- 3) Press the **APR** Key.

When GPS Approach Mode is armed, Glidepath Mode is also armed.

Selecting GPS Approach Mode:

- 1) Ensure a GPS approach is loaded into the active flight plan. The active waypoint must be part of the flight plan (cannot be a direct-to a waypoint not in the flight plan).
- 2) Ensure that GPS is the selected navigation source (use the **CDI** Softkey to cycle through navigation sources if necessary).
- 3) Press the **APR** Key.

GPS	ROL	PIT	ALT
-----	-----	-----	-----

Figure 7-24 Navigation/Approach Mode Armed

LOC Approach Mode allows the autopilot to fly a LOC/ILS approach with a glideslope. When LOC Approach Mode is armed, Glideslope Mode is also armed automatically. LOC captures are inhibited if the difference between aircraft heading and localizer course exceeds 105°.

Selecting LOC Approach Mode:

- 1) Ensure a valid localizer frequency is tuned.
- 2) Ensure that LOC is the selected navigation source (use the **CDI** Softkey to cycle through navigation sources if necessary).
- 3) Press the **APR** Key.

Or:

- 1) Ensure that GPS is the selected navigation source (use the **CDI** Softkey to cycle through navigation sources if necessary).
- 2) Ensure a LOC/ILS approach is loaded into the active flight plan.
- 3) Ensure the corresponding LOC frequency is tuned.
- 4) Press the **APR** Key.

If the following occurs, the flight director reverts to Roll Hold Mode (wings rolled level):

- Approach Mode is active and a Vectors-To-Final is activated
- Approach Mode is active and Navigation source is manually switched
- During a LOC/ILS Approach GPS Navigation Mode is active and the FAF is crossed after the automatic navigation source switch from GPS to LOC

CHANGING THE SELECTED COURSE

The Selected Course is controlled using the **CRS** Knob (while in VOR, LOC, or OBS Mode). Pressing the **CWS** Button and hand-flying the aircraft does not change the Selected Course while in Approach Mode. The autopilot guides the aircraft back to the Selected Course (or GPS flight plan) when the **CWS** Button is released.

INTERCEPTING AND FLYING A DME ARC

The AFCS will intercept and track a DME arc that is part of the active flight plan provided that GPS Navigation Mode is engaged, GPS is the active navigation source on the CDI, and the DME arc segment is the active flight plan leg. It is important to note that automatic navigation of DME arcs is based on GPS. Thus, even if the APR key is pressed and LOC or VOR Approach Mode is armed prior to reaching the Initial Approach Fix (IAF), Approach Mode will not activate until the arc segment is completed.

If the pilot decides to intercept the arc at a location other than the published IAF (i.e. ATC provides vectors to intercept the arc) and subsequently selects Heading Mode or Roll Mode, the AFCS will not automatically intercept or track the arc unless the pilot activates the arc leg of the flight plan and arms GPS Navigation Mode. The AFCS will not intercept and fly a DME arc before reaching an IAF that defines the beginning of the arc segment. Likewise, if at any point while established on the DME arc the pilot deselects GPS Navigation Mode, the AFCS will no longer track the arc.

BACKCOURSE MODE (BC)

NOTE: When making a backcourse approach, set the Selected Course to the localizer front course.

Backcourse Mode captures and tracks a localizer signal in the backcourse direction. The mode may be selected by pressing the **BC** Key. Backcourse Mode is armed if the CDI is greater than one dot when the mode is selected. If the CDI is less than one dot, the Backcourse Mode is automatically captured when the **BC** Key is pressed. The flight director creates roll steering commands from the Selected Course and deviation when in Backcourse Mode.

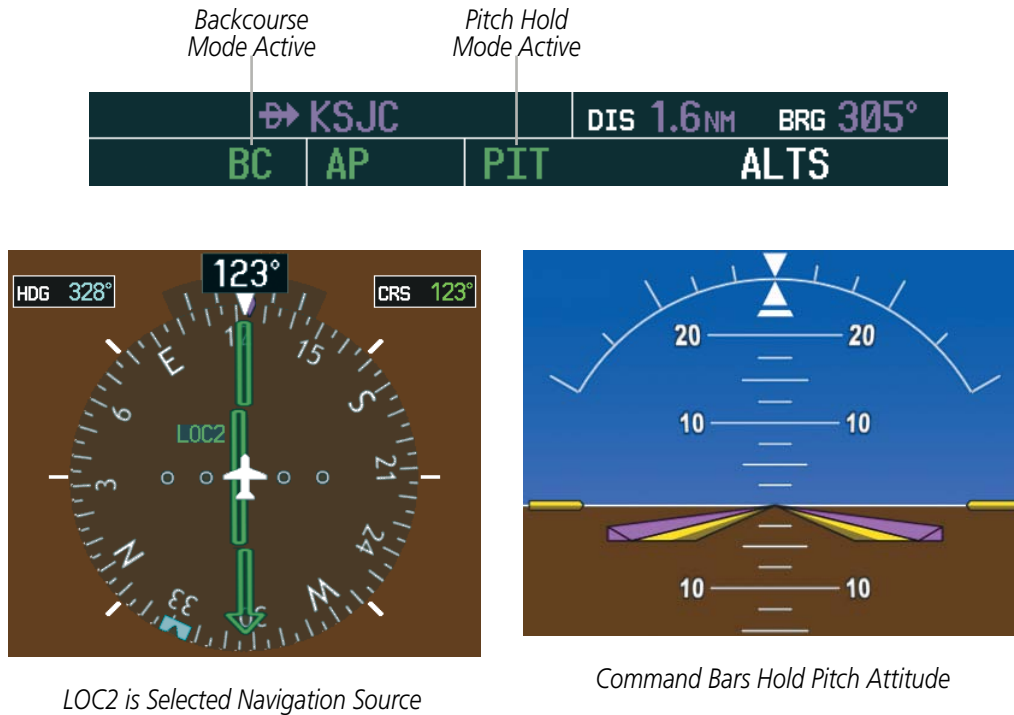

Figure 7-25 Backcourse Mode

CHANGING THE SELECTED COURSE

The Selected Course is controlled using the **CRS** Knob. Pressing the **CWS** Button and hand-flying the aircraft does not reset any reference data while in Backcourse Mode. The autopilot guides the aircraft back to the Selected Course when the **CWS** Button is released.

7.5 AUTOPILOT OPERATION



NOTE: Refer to the POH for specific instructions regarding emergency procedures.

The autopilot operates flight control surface servos to provide automatic flight control. Pitch and roll commands are provided to the servos, based on the active flight director modes. The autopilot uses pitch and roll rates to stabilize the aircraft attitude during upsets and flight director maneuvers. Flight director commands are rate- and attitude-limited, combined with pitch and roll damper control, and sent to the pitch and roll servo motors.

Pitch autotrim provides trim commands to the pitch trim servo to relieve any sustained effort required by the pitch servo. The pitch servo measures the output effort (torque) and provides this signal to the pitch trim servo. The pitch trim servo commands the motor to reduce the average pitch servo effort.

When the autopilot is not engaged, the pitch trim servo may be used to provide manual electric trim (MET). This allows the aircraft to be trimmed using a control wheel switch rather than the trim wheel. Manual trim commands are generated with the **MET** Switch. Trim speeds are scheduled with airspeed to provide more consistent response.

Servo motor control limits the maximum servo speed and torque. The servo mounts are equipped with slip-clutches set to certain values. This allows the servos to be overridden in case of an emergency.

ENGAGING THE AUTOPILOT



NOTE: Autopilot engagement/disengagement is not equivalent to servo engagement/disengagement. Use the CWS Button to disengage the pitch and roll servos while the autopilot remains active.

When the **AP** Key is pressed, the autopilot and flight director (if not already engaged) are activated. Engagement is indicated by a green 'AP' annunciation in the center of the AFCS Status Box. The flight director engages in Pitch and Roll Hold modes when initially activated.



Figure 7-26 Autopilot Engaged

SYSTEM OVERVIEW

FLIGHT INSTRUMENTS

EIS

AUDIO PANEL & CNS

FLIGHT MANAGEMENT

HAZARD AVOIDANCE

AFCS

ADDITIONAL FEATURES

APPENDICES

INDEX

CONTROL WHEEL STEERING

During autopilot operation, the aircraft may be hand-flown without disengaging the autopilot. Pressing and holding the **CWS** Button disengages the pitch and roll servos from the flight control surfaces and allows the aircraft to be hand-flown. At the same time, the flight director is synchronized to the aircraft attitude during the maneuver. The ‘AP’ annunciation is temporarily replaced by ‘CWS’ in white for the duration of CWS maneuvers.

In most scenarios, releasing the **CWS** Button reengages the autopilot with a new reference. Refer to the flight director modes section for CWS behavior in each mode.

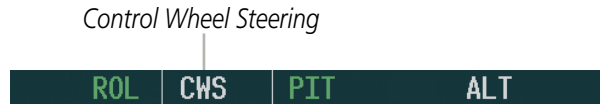

Figure 7-27 CWS Annunciation

DISENGAGING THE AUTOPILOT

The autopilot is manually disengaged by pushing the **AP DISC** Switch, **GA** Switch or the **AP** Key on the MFD. Manual disengagement is indicated by a five-second flashing yellow ‘AP’ annunciation and a two-second autopilot disconnect aural alert. After manual disengagement, the autopilot disconnect aural alert may be cancelled by pushing the **AP DISC** or **MET** Switch (**AP DISC** Switch also cancels the flashing ‘AP’ annunciation).

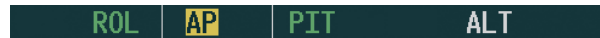

Figure 7-28 Manual Autopilot Disengagement

Automatic autopilot disengagement is indicated by a flashing red ‘AP’ annunciation and by the autopilot disconnect aural alert, which continue until acknowledged by pushing the **AP DISC** or **MET** Switch. Automatic disengagement occurs due to:

- System failure
- Invalid sensor data
- Inability to compute default flight director modes (FD also disengages automatically)



Figure 7-29 Automatic Autopilot Disengagement

7.6 EXAMPLE PROCEDURES



NOTE: The following example flight plan and diagrams (not to be used for navigation) in this section are for instructional purposes only and should be considered not current. Numbered portions of accompanying diagrams correspond to numbered procedure steps.

This scenario-based set of procedures (based on the example flight plan found in the Flight Management Section) shows various GFC 700 AFCS modes used during a flight. In this scenario, the aircraft departs Charles B. Wheeler Downtown Airport (KMKC), enroute to Colorado Springs Airport (KCOS). After departure, the aircraft climbs to 12,000 ft and airway V4 is intercepted, following ATC vectors.

Airway V4 is flown to Salina VOR (SLN) using VOR navigation, then airway V244 is flown using GPS Navigation. The ILS approach for runway 35L and LPV (WAAS) approach for runway 35R are shown and a missed approach is executed.

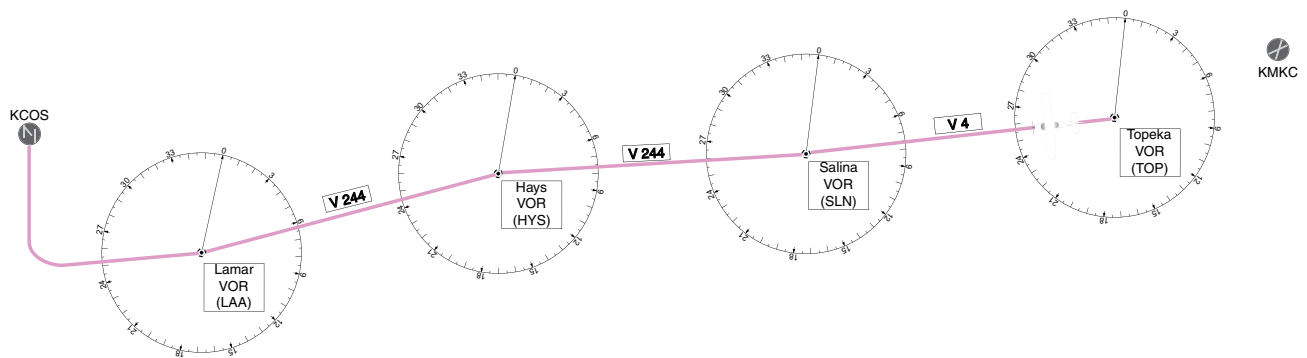

Figure 7-30 Flight Plan Overview

SYSTEM OVERVIEW

FLIGHT INSTRUMENTS

EIS

AUDIO PANEL & CNS

FLIGHT MANAGEMENT

HAZARD AVOIDANCE

AFCS

ADDITIONAL FEATURES

APPENDICES

INDEX

DEPARTURE

Climbing to the Selected Altitude and flying an assigned heading:

- 1) Before takeoff, set the Selected Altitude to 12,000 feet using the **ALT** Knob.
- 2) In this example, Vertical Speed Mode is used to capture the Selected Altitude (Pitch Hold, Vertical Speed, or Flight Level Change Mode may be used).
 - a) Press the **VS** Key to activate Vertical Speed Mode.



The Vertical Speed Reference may be adjusted after Vertical Speed Mode is selected using the **NOSE UP/NOSE DN** keys or pushing the **CWS** Button while hand-flying the aircraft to establish a new Vertical Speed Reference.

- b) Press the **AP** Key to engage the autopilot in a climb using Vertical Speed Mode.



- 3) Use the **HDG** Knob to set the Selected Heading, complying with ATC vectors to intercept Airway V4. Press the **HDG** Key to activate Heading Select Mode while the autopilot is engaged in the climb. The autopilot follows the Selected Heading Bug on the HSI and turns the aircraft to the desired heading.

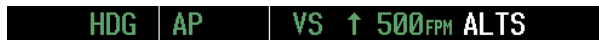

- 4) As the aircraft nears the Selected Altitude, the flight director transitions to Selected Altitude Capture Mode, indicated by the green 'ALTS' annunciation flashing for up to 10 seconds.



At 50 feet from the Selected Altitude, the green 'ALT' annunciation flashes for up to 10 seconds; the autopilot transitions to Altitude Hold Mode and levels the aircraft.



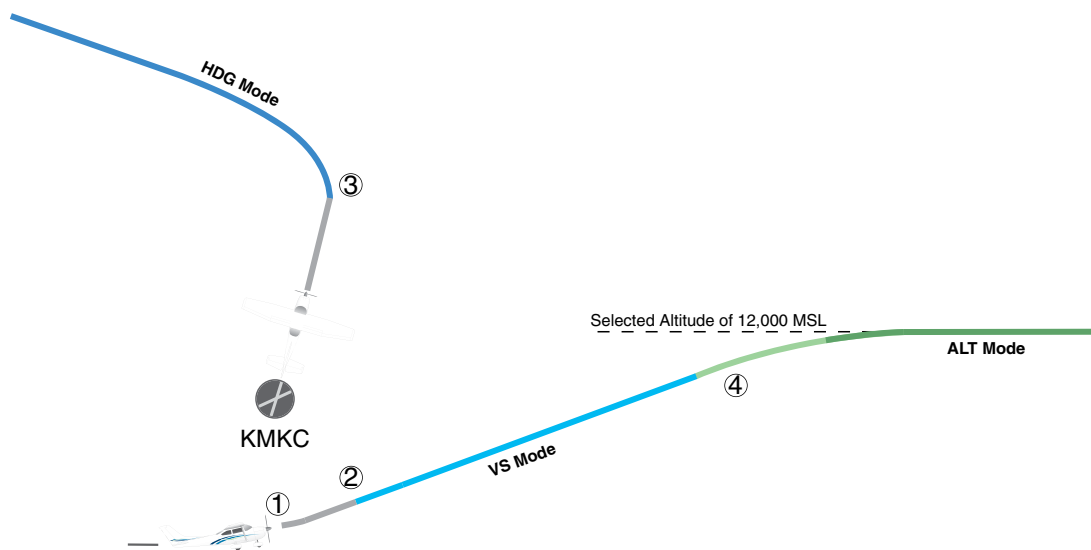

Figure 7-31 Departure

INTERCEPTING A VOR RADIAL

During climb-out, the autopilot continues to fly the aircraft in Heading Select Mode. Airway V4 to Salina VOR (SLN) should now be intercepted. Since the enroute flight plan waypoints correspond to VORs, flight director Navigation Mode using either VOR or GPS as the navigation source may be used. In this scenario, VOR Navigation Mode is used for navigation to the first VOR waypoint in the flight plan.

Intercepting a VOR radial:

- 1) Arm VOR Navigation Mode:
 - a) Tune the VOR frequency.
 - b) Press the **CDI** Softkey to set the navigation source to VOR.
 - c) Use the **CRS** Knob to set the Selected Course to 255°. Note that at this point, the flight director is still in Heading Select Mode and the autopilot continues to fly 290°.
 - d) Press the **NAV** Key. This arms VOR Navigation Mode and the white 'VOR' annunciation appears to the left of the active lateral mode.

VOR HDG AP ALT 12000FT

- 2) As the aircraft nears the Selected Course, the flight director transitions from Heading Select to VOR Navigation Mode and the 'VOR' annunciation flashes green. The autopilot begins turning to intercept the Selected Course.

VOR AP ALT 12000FT

- 3) The autopilot continues the turn until the aircraft is established on the Selected Course.

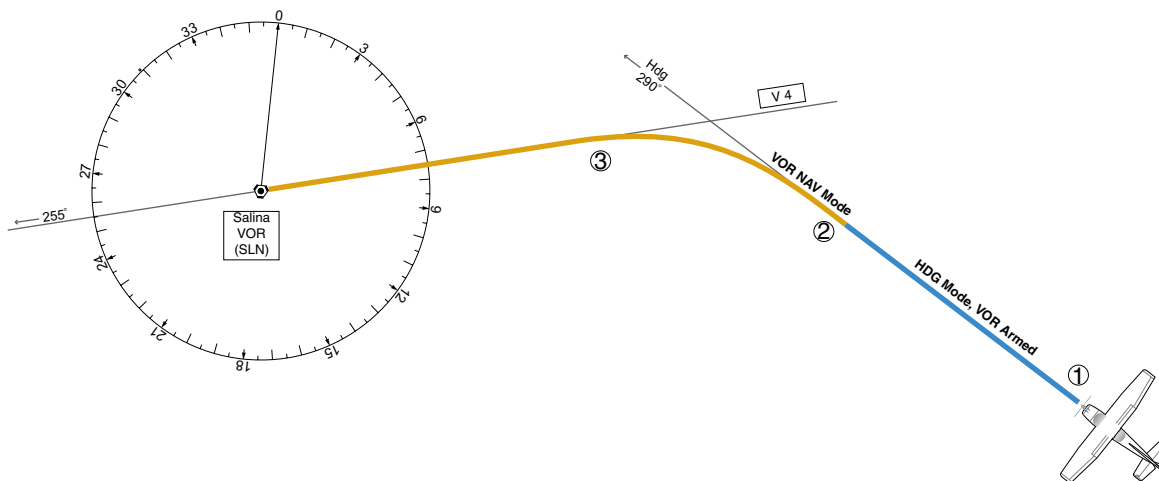

Figure 7-32 Intercepting a VOR Radial

FLYING A FLIGHT PLAN/GPS COURSE

NOTE: Changing the navigation source cancels Navigation Mode and causes the flight director to revert back to Roll Hold Mode (wings rolled level).

As the aircraft closes on Salina VOR, GPS is used to navigate the next leg, airway V244. The aircraft is currently tracking inbound on Airway V4.

Flying a GPS flight plan:

- 1) Transition from VOR to GPS Navigation Mode:
 - a) Press the **CDI** Softkey until GPS is the selected navigation source.
 - b) Press the **NAV** Key to activate GPS Navigation Mode. The autopilot guides the aircraft along the active flight plan leg.



- 2) Following the flight plan, the autopilot continues to steer the aircraft under GPS guidance. Note that in GPS Navigation Mode, course changes defined by the flight plan are automatically made without pilot action required.

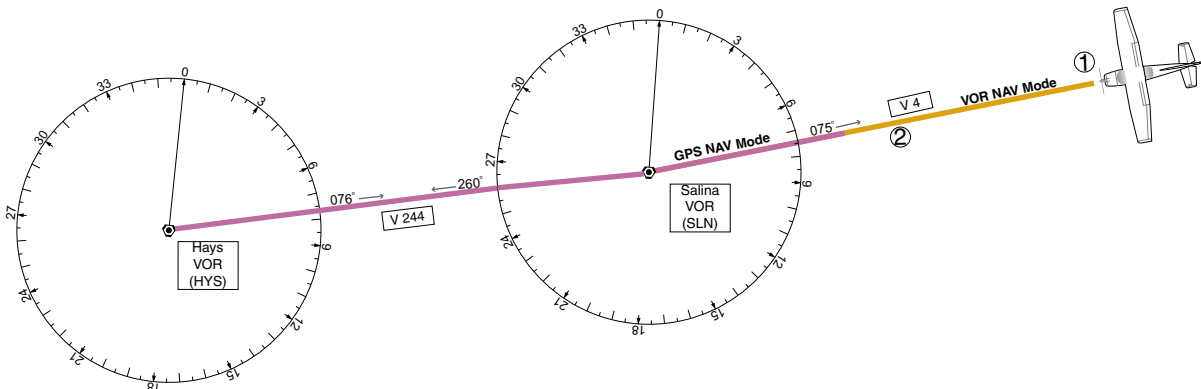

Figure 7-33 Transition to GPS Flight Plan

DESCENT

While flying the arrival procedure, the aircraft is cleared for descent in preparation for the approach to KCOS. Three methods are presented for descent:

- Flight Level Change descent – Flight Level Change Mode can be used to descend to the Selected Altitude at a constant airspeed. This descent method does not account for flight plan waypoint altitude constraints.
- Vertical Path Tracking descent – Vertical Path Tracking Mode is used to follow the vertical descent path defined in the GPS flight plan. Altitude constraints correspond to waypoints in the flight plan. Before VNV flight control can provide vertical profile guidance, a VNV flight plan must be entered and enabled.
- Non-path descent in a VNV scenario – A VNV flight plan is entered and enabled, however Pitch Hold, Vertical Speed, or Flight Level Change Mode can be used to descend to the VNV Target Altitude prior to reaching the planned TOD. Flight Level Change Mode is used in the example.

Flight Level Change descent:

- 1) Select Flight Level Change Mode:
 - a) Using the **ALT** Knob, set the Selected Altitude to 10,000 feet.
 - b) Press the **FLC** Key to activate Flight Level Change Mode. The annunciation 'FLC' appears next to the Airspeed Reference, which defaults to the current aircraft airspeed. Selected Altitude Capture Mode is armed automatically.



- 2) Use the **NOSE UP/NOSE DN** keys or push the **CWS** Button while hand-flying the aircraft to adjust the commanded airspeed while maintaining the same power, or reduce power to allow descent in Flight Level Change Mode while the autopilot maintains the current airspeed.
- 3) As the aircraft nears the Selected Altitude, the flight director transitions to Selected Altitude Capture Mode, indicated by the green 'ALTS' annunciation flashing for up to 10 seconds.



The green 'ALT' annunciation flashes for up to 10 seconds upon reaching 50 feet from the Selected Altitude; the autopilot transitions to Altitude Hold Mode and levels the aircraft.

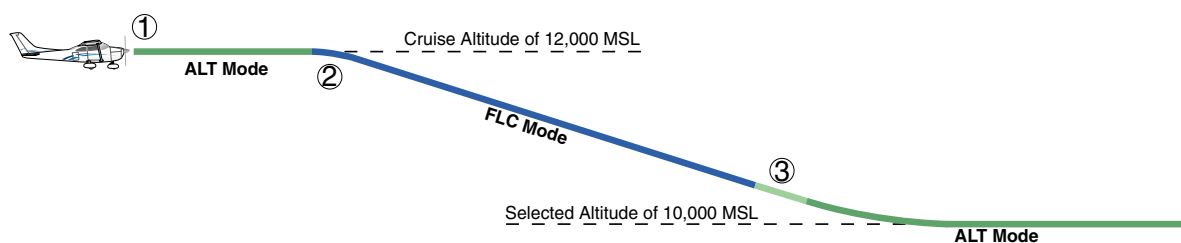

Figure 7-34 FLC Descent

Vertical Path Tracking descent to VNV Target Altitude:

- 1) Select VNV flight control:
 - a) Press the **VNV** Key to arm Vertical Path Tracking Mode. The white annunciation 'VPTH' appears.



- b) Using the **ALT** Knob, set the Selected Altitude below the flight plan's VNV Target Altitude of 10,000 feet.

If the Selected Altitude is not at least 75 ft below the VNV Target Altitude, the flight director captures the Selected Altitude rather than the VNV Target Altitude once Vertical Path Tracking Mode becomes active (ALTS is armed rather than ALT).
- c) If Vertical Path Tracking Mode is armed more than 5 minutes prior to descent path capture, acknowledgment is required for the flight director to transition from Altitude Hold to Vertical Path Tracking Mode. To proceed with descent path capture if the white 'VPTH' annunciation begins flashing, do one of the following
 - Press the **VNV** Key
 - Turn the **ALT** Knob to adjust the Selected Altitude

If the descent is not confirmed by the time of interception, Vertical Path Tracking Mode remains armed and the descent is not captured.

- 2) When the top of descent (TOD) is reached, the flight director transitions to Vertical Path Tracking Mode and begins the descent to the VNV Target Altitude. Intention to capture the VNV Target Altitude is indicated by the white 'ALTV' annunciation.



- 3) As the aircraft nears the VNV Target Altitude, the flight director transitions to VNV Target Altitude Capture Mode, indicated by the green 'ALTV' annunciation flashing for up to 10 seconds.



The green 'ALT' annunciation flashes for up to 10 seconds upon reaching 50 feet from the VNV Target Altitude; the autopilot transitions to Altitude Hold Mode and levels the aircraft at the vertical waypoint.

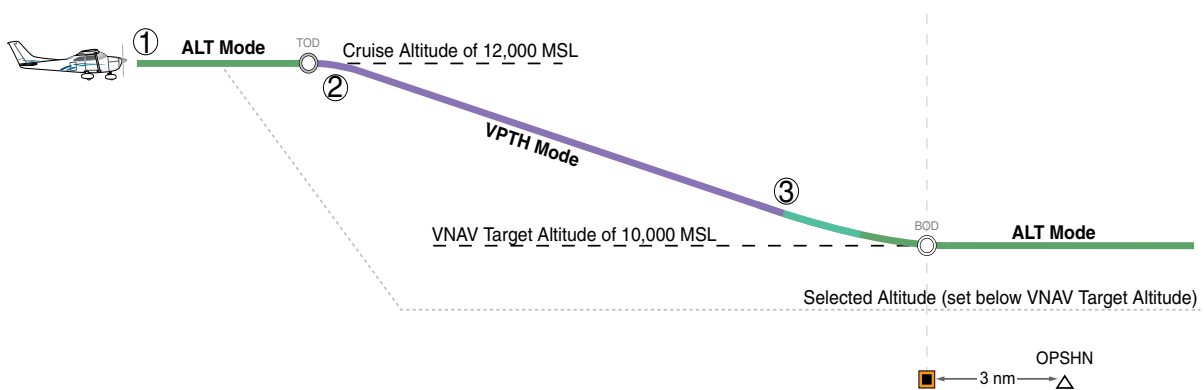

Figure 7-35 VPTH Descent

Non-path descent using Flight Level Change Mode:

- 1) Using Flight Level Change Mode, command a non-path descent to an intermediate altitude above the next VNV flight plan altitude:
 - a) Using the **ALT** Knob, set the Selected Altitude below the current aircraft altitude to an altitude (in this case, 9,400 feet) at which to level off between VNV flight plan altitudes.
 - b) Press the **FLC** Key before the planned TOD during an altitude hold while VPTH is armed. The Airspeed Reference defaults to the current aircraft airspeed. Vertical Path Tracking and Selected Altitude Capture Mode are armed automatically.

GPS | AP | FLC | 130KT | **ALTS** | VPTH

- 2) Reduce power to allow descent in Flight Level Change Mode. The autopilot maintains the Airspeed Reference.
- 3) As the aircraft nears the Selected Altitude, the flight director transitions to Selected Altitude Capture Mode, indicated by the green 'ALTS' annunciation flashing for up to 10 seconds.

GPS | AP | **ALTS** | 9400FT | ALT | VPTH

The green 'ALT' annunciation flashes for up to 10 seconds upon reaching 50 feet from the Selected Altitude; the autopilot transitions to Altitude Hold Mode and levels the aircraft. After leveling off reset, Selected Altitude at or below 9,000 ft.

GPS | AP | **ALT** | 9400FT | VPTH

- 4) When the next TOD is reached, Vertical Path Tracking becomes active (may require acknowledgment to allow descent path capture).

GPS | AP | VPTH | **ALTV**

- 5) As the aircraft nears the VNV Target Altitude, the flight director transitions to VNV Target Altitude Capture Mode, indicated by the green 'ALTV' annunciation flashing for up to 10 seconds.

GPS | AP | **ALTV** | 9000FT | ALT

The green 'ALT' annunciation flashes for up to 10 seconds upon reaching 50 feet from the VNV Target Altitude; the autopilot transitions to Altitude Hold Mode and levels the aircraft at the vertical waypoint.

GPS | AP | **ALT** | 9000FT

- SYSTEM OVERVIEW
- FLIGHT INSTRUMENTS
- EIS
- AUDIO PANEL & CNS
- FLIGHT MANAGEMENT
- HAZARD AVOIDANCE
- AFCS
- ADDITIONAL FEATURES
- APPENDICES
- INDEX

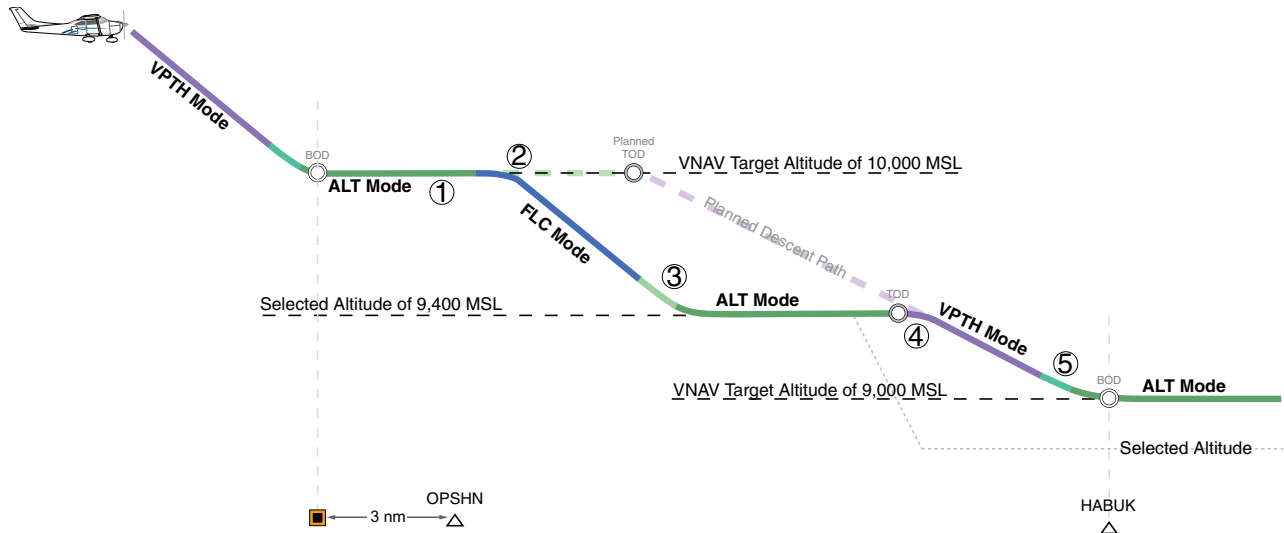

Figure 7-36 Non-path Descent

APPROACH



NOTE: If an approach contains a DME arc, the arc must be flown in Navigation Mode with the GFC 700. When receiving vectors from ATC, Navigation Mode must be selected prior to intercepting the ARC.

Flying an ILS approach:

- 1) Transition from GPS Navigation Mode to Heading Select Mode.
 - a) Select the Runway 35L ILS approach for KCOS and select 'VECTORS' for the transition. Load and activate the approach into the flight plan.
 - b) Use the **HDG** Knob to set the Selected Heading after getting vectors from ATC.
 - c) Press the **HDG** Key. The autopilot turns the aircraft to the desired heading.
 - d) Use Heading Select Mode to comply with ATC vectors as requested.

HDG | AP | ALT 9000FT

- 2) Arm LOC Approach and Glideslope modes.
 - a) Ensure the appropriate localizer frequency is tuned.
 - b) Press the **APR** Key when cleared for approach to arm Approach and Glideslope modes. 'LOC' and 'GS' appear in white as armed mode annunciations.

LOC | HDG | AP | ALT 9000FT | GS

- c) The navigation source automatically switches to LOC. After this switch occurs, the localizer signal can be captured and the flight director determines when to begin the turn to intercept the final approach course. The flight director now provides guidance to the missed approach point.

- 3) There are two options available at this point, as the autopilot flies the ILS approach:
- Push the **AP DISC** Switch at the decision height and land the aircraft.
 - Use the **GA** Switch to execute a missed approach.

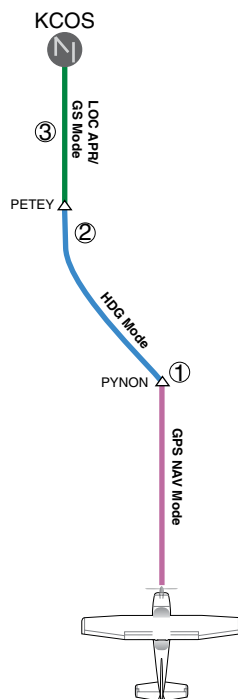

Figure 7-37 ILS Approach to KCOS



NOTE: Support for SBAS precision approaches is available only in installations with GIA 63W IAUs when SBAS is available.

Flying a RNAV GPS approach with vertical guidance:

- 1) Arm flight director modes for a RNAV GPS approach with vertical guidance:
 - a) Make sure the navigation source is set to GPS (use **CDI** Softkey to change navigation source).
 - b) Select the Runway 35R LPV approach for KCOS. Load and activate the approach into the flight plan.
- 2) Press the **APR** Key once clearance for approach has been received. GPS Approach Mode is activated and Glidepath Mode is armed.

GPS	AP	VPTH	ALTS GP
-----	----	------	---------

- 3) Once the glidepath is captured, Glidepath Mode becomes active. The flight director now provides guidance to the missed approach point.

GPS	AP	GP
-----	----	----

- 4) There are two options available at this point, as the autopilot flies the approach:
 - Push the **AP DISC** Switch at the Decision height and land the aircraft.
 - Use the **GA** Switch to execute a missed approach.

- SYSTEM OVERVIEW
- FLIGHT INSTRUMENTS
- EIS
- AUDIO PANEL & CNS
- FLIGHT MANAGEMENT
- HAZARD AVOIDANCE
- AFCS
- ADDITIONAL FEATURES
- APPENDICES
- INDEX

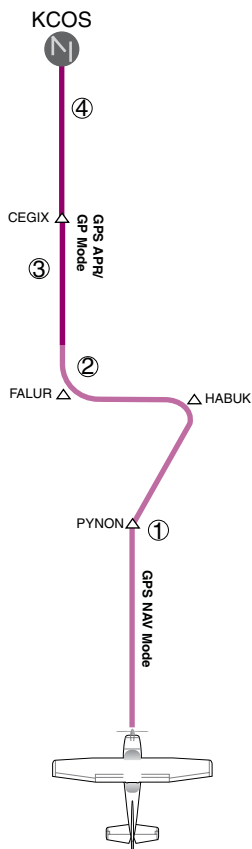

Figure 7-38 LPV Approach to KCOS

GO AROUND/MISSED APPROACH



NOTE: As a result of calculations performed by the system while flying the holding pattern, the display may re-size automatically and the aircraft may not precisely track the holding pattern as depicted on the PFD and MFD.

Flying a missed approach:

- 1) Push the **GA** Switch at the Decision height and apply go around power to execute a missed approach. The flight director Command Bars establish a nose-up climb to follow. If flying an ILS or LOC approach the CDI also switches to GPS as the navigation source.

Note that when the **GA** Switch is pushed, the missed approach is activated and the autopilot disconnects, indicated by the 'AP' annunciation flashing yellow for 5 seconds and the autopilot disconnect aural alert.

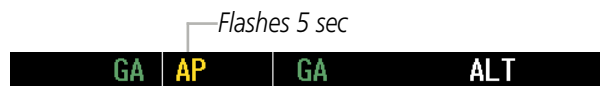

- 2) Start the climb to the prescribed altitude in the published Missed Approach Procedure (in this case, 10,000 ft).
 - a) Press the **AP** Key to re-engage the autopilot.
 - b) Press the **NAV** Key to have the autopilot fly to the hold.



- 3) Use the **ALT** Knob to set a Selected Altitude to hold.

To hold the current airspeed during the climb, press the **FLC** Key.



As the aircraft nears the Selected Altitude, the flight director transitions to Selected Altitude Capture Mode, indicated by the green 'ALTS' annunciation flashing for up to 10 seconds.



The green 'ALT' annunciation flashes for up to 10 seconds upon reaching 50 feet from the Selected Altitude; the autopilot transitions to Altitude Hold Mode and levels the aircraft.



- 4) The autopilot flies the holding pattern after the missed approach is activated. Annunciations are displayed in the Navigation Status Box, above the AFCS Status Box.



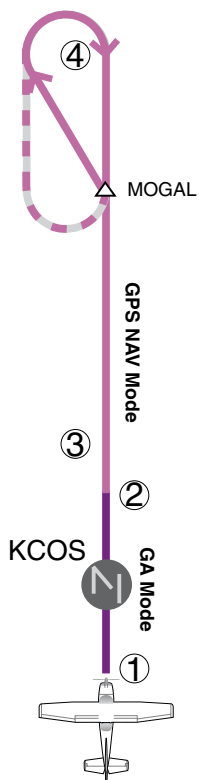

Figure 7-39 Go Around/Missed Approach

7.7 AFCS ANNUNCIATIONS AND ALERTS

AFCS STATUS ALERTS

The annunciations in Table 7-5 (listed in order of increasing priority) can appear on the PFD above the Airspeed and Attitude indicators. Only one annunciation occurs at a time, and messages are prioritized by criticality.

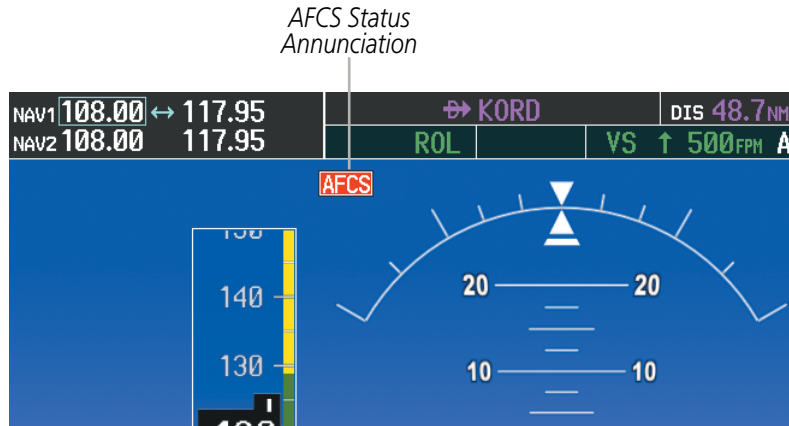

Figure 7-40 AFCS Status Annunciation

Alert Condition	Annunciation	Description
Aileron Mistrim Right	AIL→	Roll servo providing sustained force in the indicated direction
Aileron Mistrim Left	←AIL	
Elevator Mistrim Down	↓ELE	Pitch servo providing sustained force in the indicated direction
Elevator Mistrim Up	↑ELE	
Pitch Trim Failure)	PTRM	If AP engaged, take control of the aircraft and disengage AP
Roll Failure	ROLL	Roll axis control failure; AP inoperative
Pitch Failure	PTCH	Pitch axis control failure; AP inoperative
System Failure	AFCS	AP and MET are unavailable; FD may still be available
Preflight Test	PFT	Performing preflight system test; aural alert sounds at completion Do not press the AP DISC Switch during servo power-up and preflight system tests as this may cause the preflight system test to fail or never to start (if servos fail their power-up tests). Power must be cycled to the servos to remedy the situation.
	PFT	Preflight system test failed; aural alert sounds at failure

Table 7-5 AFCS Status Alerts

OVERSPEED PROTECTION



NOTE: Overspeed protection is not active in Altitude Hold, Glideslope or Glidepath modes.

While Pitch Hold, Vertical Speed, Flight Level Change, Vertical Path Tracking, or an altitude capture mode is active, airspeed is monitored by the flight director. Pitch commands are not changed until overspeed protection becomes active. Overspeed protection is provided in situations where the flight director cannot acquire and maintain the mode reference for the selected vertical mode without exceeding the certified maximum autopilot airspeed.

When an autopilot overspeed condition occurs, the Airspeed Reference appears in a box above the Airspeed Indicator, flashing a yellow 'MAXSPD' annunciation. Engine power should be reduced and/or the pitch reference adjusted to slow the aircraft. The annunciation disappears when the overspeed condition is resolved.

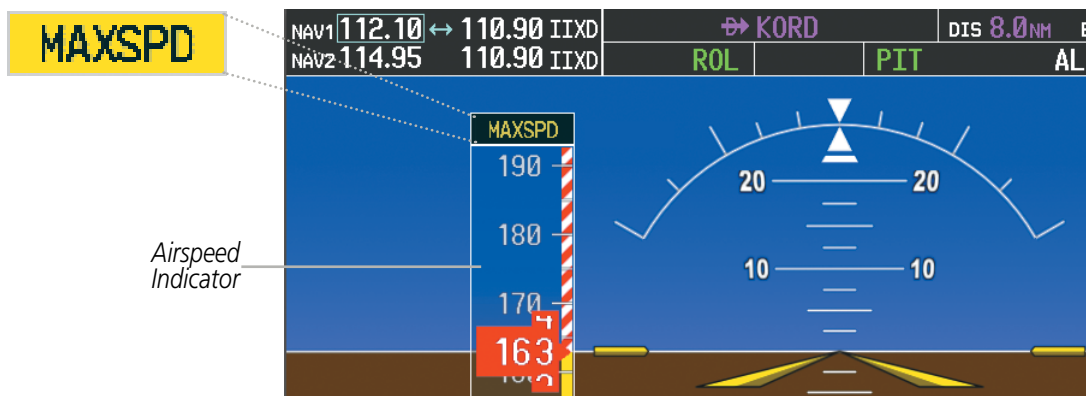

Figure 7-41 Overspeed Annunciation

SYSTEM
OVERVIEW

FLIGHT
INSTRUMENTS

EIS

AUDIO PANEL
& CNS

FLIGHT
MANAGEMENT

HAZARD
AVOIDANCE

AFCS

ADDITIONAL
FEATURES

APPENDICES

INDEX

BLANK PAGE

SECTION 8 ADDITIONAL FEATURES



NOTE: *With the availability of SafeTaxi®, ChartView, or FliteCharts®, it may be necessary to carry another source of charts on-board the aircraft.*

Additional features of the system include the following:

- Synthetic Vision System (SVS)(Optional)
- SafeTaxi® diagrams
- ChartView and FliteCharts® electronic charts (Optional)
- SiriusXM Satellite Radio entertainment (Optional)
- Scheduler
- Electronic Checklists (Optional)
- Flight Data Logging
- Auxiliary Video (Optional)

The optional Synthetic Vision System (SVS) provides a three-dimensional forward view of terrain features on the PFD. SVS imagery shows the pilot's view of relevant features in relation to the aircraft attitude, as well as the flight path pertaining to the active flight plan.

SafeTaxi diagrams provide detailed taxiway, runway, and ramp information at more than 700 airports in the United States. By decreasing range on an airport that has a SafeTaxi diagram available, a close up view of the airport layout can be seen.

The optional ChartView and FliteCharts provide on-board electronic terminal procedures charts. Electronic charts offer the convenience of rapid access to essential information. Either ChartView or FliteCharts may be configured in the system, but not both.

The optional SiriusXM Satellite Radio entertainment audio feature of the GDL 69A Data Link Receiver handles more than 170 channels of music, news, and sports. SiriusXM Satellite Radio offers more entertainment choices and longer range coverage than commercial broadcast stations.

The Scheduler feature can be used to enter and display short term or long term reminder messages such as Switch fuel tanks, Change oil, or Altimeter-Transponder Check in the Messages Window on the PFD.

Optional checklists help to quickly find the proper procedure on the ground or during flight.

The Flight Data Logging feature automatically stores critical flight and engine data on an SD data card. Approximately 1,000 flight hours can be recorded for each 1GB of available space on the card.

The G1000 system provides a control and display interface to an optional auxiliary video system. The system can display video for up to two inputs.

8.1 SYNTHETIC VISION SYSTEM (SVS) (OPTIONAL)



WARNING: Use appropriate primary systems for navigation, and for terrain, obstacle, and traffic avoidance. SVS is intended as an aid to situational awareness only and may not provide either the accuracy or reliability upon which to solely base decisions and/or plan maneuvers to avoid terrain, obstacles, or traffic.

The optional Synthetic Vision System (SVS) is a visual enhancement to the G1000 Integrated Flight Deck. SVS depicts a forward-looking attitude display of the topography immediately in front of the aircraft. The field of view is 30 degrees to the left and 35 degrees to the right. SVS information is shown on the Primary Flight Display (PFD), or on the Multifunction Display (MFD) in Reversionary Mode (Figure 8-91). The depicted imagery is derived from the aircraft attitude, heading, GPS three-dimensional position, and a nine arc-second database of terrain, obstacles, and other relevant features. The terrain data resolution of nine arc-seconds, meaning that the terrain elevation contours are stored in squares measuring nine arc-seconds on each side, is required for the operation of SVS. Loss of any of the required data, including temporary loss of the GPS signal, will cause SVS to be disabled until the required data is restored.

The SVS terrain display shows land contours (colors are consistent with those of the topographical map display), large water features, towers, and other obstacles over 200' AGL that are included in the obstacle database. Cultural features on the ground such as roads, highways, railroad tracks, cities, and state boundaries are not displayed even if those features are found on the MFD map. The terrain display also includes a north–south east–west grid with lines oriented with true north and spaced at one arc-minute intervals to assist in orientation relative to the terrain.

The optional Terrain Awareness and Warning System (TAWS) or standard Terrain-SVS is integrated within SVS to provide visual and auditory alerts to indicate the presence of terrain and obstacle threats relevant to the projected flight path. Terrain alerts are displayed in red and yellow shading on the PFD.

The terrain display is intended for situational awareness only. It may not provide the accuracy or fidelity on which to base decisions and plan maneuvers to avoid terrain or obstacles. Navigation must not be predicated solely upon the use of the Terrain–SVS or TAWS terrain or obstacle data displayed by the SVS.

The following SVS enhancements appear on the PFD:

- Pathways
- Flight Path Marker
- Horizon Heading Marks
- Traffic Display
- Airport Signs
- Runway Display
- Terrain Alerting
- Obstacle Alerting

SYSTEM OVERVIEW

FLIGHT INSTRUMENTS

EIS

AUDIO PANEL & CNS

FLIGHT MANAGEMENT

HAZARD AVOIDANCE

AFCS

ADDITIONAL FEATURES

APPENDICES

INDEX



Figure 8-1 Synthetic Vision Imagery

SVS OPERATION

SVS is activated from the PFD using the softkeys located along the bottom edge of the display. Pressing the softkeys turns the related function on or off. When SVS is enabled, the pitch scale increments are reduced to 10 degrees up and 7.5 degrees down.

SVS functions are displayed on three levels of softkeys. The **PFD** Softkey leads into the PFD function Softkeys, including synthetic vision. Pressing the **SYN VIS** Softkey displays the SVS feature softkeys. The softkeys are labeled **PATHWAY**, **SYN TERR**, **HRZN HDG**, and **APTSIGNS**. The **BACK** Softkey returns to the previous level of softkeys. Synthetic Terrain must be active before any other SVS feature may be activated.

HRZN HDG, **APTSIGNS**, and **PATHWAY** Softkeys are only available when the **SYN TERR** Softkey is activated (gray with black characters). After activating the **SYN TERR** Softkey, the **HRZN HDG**, **APTSIGNS**, and **PATHWAY** softkeys may be activated in any combination to display desired features. When system power is cycled, the last selected state (on or off) of the **SYN TERR**, **HRZN HDG**, **APTSIGNS**, and **PATHWAY** softkeys is remembered by the system.

- **PATHWAY** Softkey enables display of rectangular boxes that represent course guidance.
- **SYN TERR** Softkey enables synthetic terrain depiction.
- **HRZN HDG** Softkey enables horizon heading marks and digits.
- **APTSIGNS** Softkey enables airport signposts.

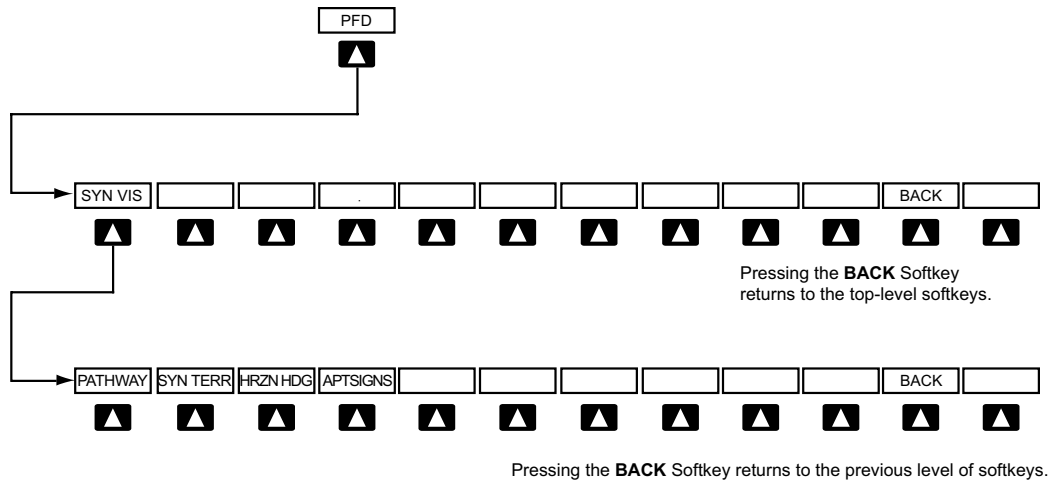

Figure 8-2 SVS Softkeys

Activating and deactivating SVS:

- 1) Press the **PFD** Softkey.
- 2) Press the **SYN VIS** Softkey.
- 3) Press the **SYN TERR** Softkey. The SVS display will cycle on or off with the **SYN TERR** Softkey.

Activating and deactivating Pathways:

- 1) Press the **PFD** Softkey.
- 2) Press the **SYN VIS** Softkey.
- 3) Press the **PATHWAY** Softkey. The Pathway feature will cycle on or off with the **PATHWAY** Softkey.

Activating and deactivating Horizon Headings:

- 1) Press the **PFD** Softkey.
- 2) Press the **SYN VIS** Softkey.
- 3) Press the **HRZN HDG** Softkey. The horizon heading display will cycle on or off with the **HRZN HDG** Softkey.

Activating and deactivating Airport Signs:

- 1) Press the **PFD** Softkey.
- 2) Press the **SYN VIS** Softkey.
- 3) Press the **APTSIGNS** Softkey. Display of airport signs will cycle on or off with the **APTSIGNS** Softkey.

SVS FEATURES



Figure 8-3 SVS on the Primary Flight Display



NOTE: Pathways and terrain features are not a substitute for standard course and altitude deviation information provided by the altimeter, CDI, and VDI.

PATHWAYS

Pathways provide a three-dimensional perspective view of the selected route of flight shown as colored rectangular boxes representing the horizontal and vertical flight path of the active flight plan. The box size represents 700 feet wide by 200 feet tall during enroute, oceanic, and terminal flight phases. During an approach, the box width is 700 feet or one half full scale deviation on the HSI, whichever is less. The height is 200 feet or one half full scale deviation on the VDI, whichever is less. The altitude at which the pathway boxes are displayed is determined by the higher of either the selected altitude or the VNAV altitude programmed for the active leg in the flight plan (Figure 8-4).

The color of the rectangular boxes may be magenta, green, or white depending on the route of flight and navigation source selected. The active GPS or GPS overlay flight plan leg is represented by magenta boxes that correspond to the Magenta CDI. A localizer course is represented by green boxes that correspond to a green CDI. An inactive leg of an active flight plan is represented by white boxes corresponding to a white line drawn on the Inset map or MFD map indicating an inactive leg.

- SYSTEM OVERVIEW
- FLIGHT INSTRUMENTS
- EIS
- AUDIO PANEL & CNS
- FLIGHT MANAGEMENT
- HAZARD AVOIDANCE
- AFCS
- ADDITIONAL FEATURES
- APPENDICES
- INDEX

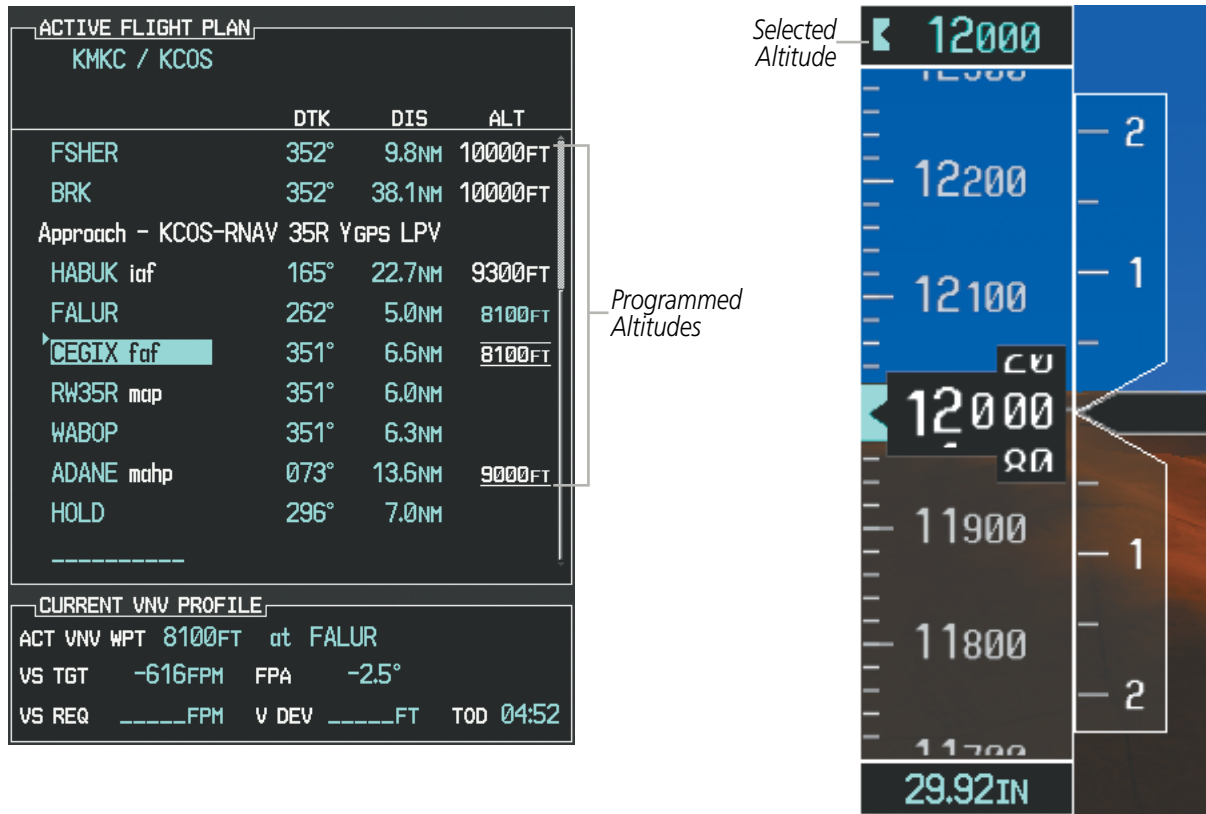

Figure 8-4 Programmed and Selected Altitude

Pathways provide supplemental glidepath information on an active ILS, LPV, LNAV/VNAV, and some LNAV approaches. Pathways are intended as an aid to situational awareness and should not be used independent of the CDI, VDI, glide path indicator, and glide slope indicator. They are removed from the display when the selected navigation information is not available. Pathways are not displayed beyond the active leg when leg sequencing is suspended and are not displayed on any portion of the flight plan leg that would lead to intercepting a leg in the wrong direction.

DEPARTURE AND ENROUTE

Prior to intercepting an active flight plan leg, pathways are displayed as a series of boxes with pointers at each corner that point in the direction of the active waypoint. Pathways are not displayed for the first leg of the flight plan if that segment is a Heading-to-Altitude leg. The first segment displaying pathways is the first active GPS leg or active leg with a GPS overlay. If this leg of the flight plan route is outside the SVS field of view, pathways will not be visible until the aircraft has turned toward this leg. While approaching the center of the active leg and prescribed altitude, the number of pathway boxes decreases to a minimum of four.

Pathways are displayed along the flight plan route at the highest of either the selected altitude or the programmed altitude for the leg. Climb profiles cannot be displayed due to the variables associated with aircraft performance. Flight plan legs requiring a climb are indicated by pathways displayed at a level above the aircraft at the altitude selected or programmed.

DESCENT AND APPROACH

Pathways are shown descending only for a programmed descent (Figures 8-5, 8-6). When the flight plan includes programmed descent segments, pathways are displayed along the descent path provided that the selected altitude is lower than the programmed altitude.

When an approach providing vertical guidance is activated, Pathways are shown level at the selected altitude up to the point along the final approach course where the altitude intercepts the extended vertical descent path, glidepath, or glideslope. From the vertical path descent, glidepath, or glideslope intercept point, the pathways are shown inbound to the Missed Approach Point (MAP) along the published lateral and vertical descent path, or at the selected altitude, whichever is lower.

During an ILS approach, the initial approach segment is displayed in magenta at the segment altitudes if GPS is selected as the navigation source on the CDI. When switching to localizer inbound with LOC selected as the navigation source on the CDI, pathways are displayed in green along the localizer and glide slope.

VOR, LOC BC, and ADF approach segments that are approved to be flown using GPS are displayed in magenta boxes. Segments that are flown using other than GPS or ILS, such as heading legs or VOR final approach courses are not displayed.

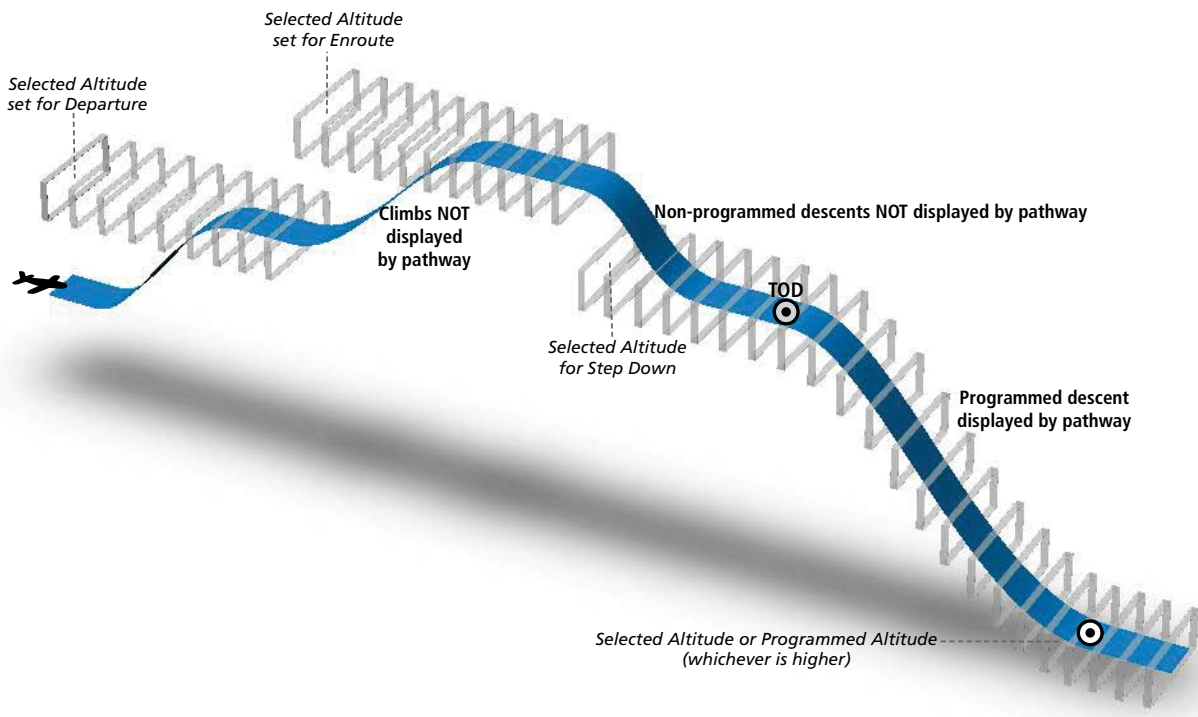

Figure 8-5 SVS Pathways, Enroute and Descent

- SYSTEM OVERVIEW
- FLIGHT INSTRUMENTS
- EIS
- AUDIO PANEL & CNS
- FLIGHT MANAGEMENT
- HAZARD AVOIDANCE
- AFCS
- ADDITIONAL FEATURES
- APPENDICES
- INDEX

MISSED APPROACH

Upon activating the missed approach, pathways lead to the Missed Approach Holding Point (MAHP) and are displayed as a level path at the published altitude for the MAHP, or the selected altitude, whichever is the highest. If the initial missed approach leg is a Course-to-Altitude (CA) leg, the pathways boxes will be displayed level at the altitude published for the MAHP. If the initial missed approach leg is defined by a course using other than GPS, pathways are not displayed for that segment. In this case, the pathways displayed for the next leg may be outside the field of view and will be visible when the aircraft has turned in the direction of that leg.

Pathways are displayed along each segment including the path required to track course reversals that are part of a procedure, such as holding patterns. Pathways boxes will not indicate a turn to a MAHP unless a defined geographical waypoint exists between the MAP and MAHP.

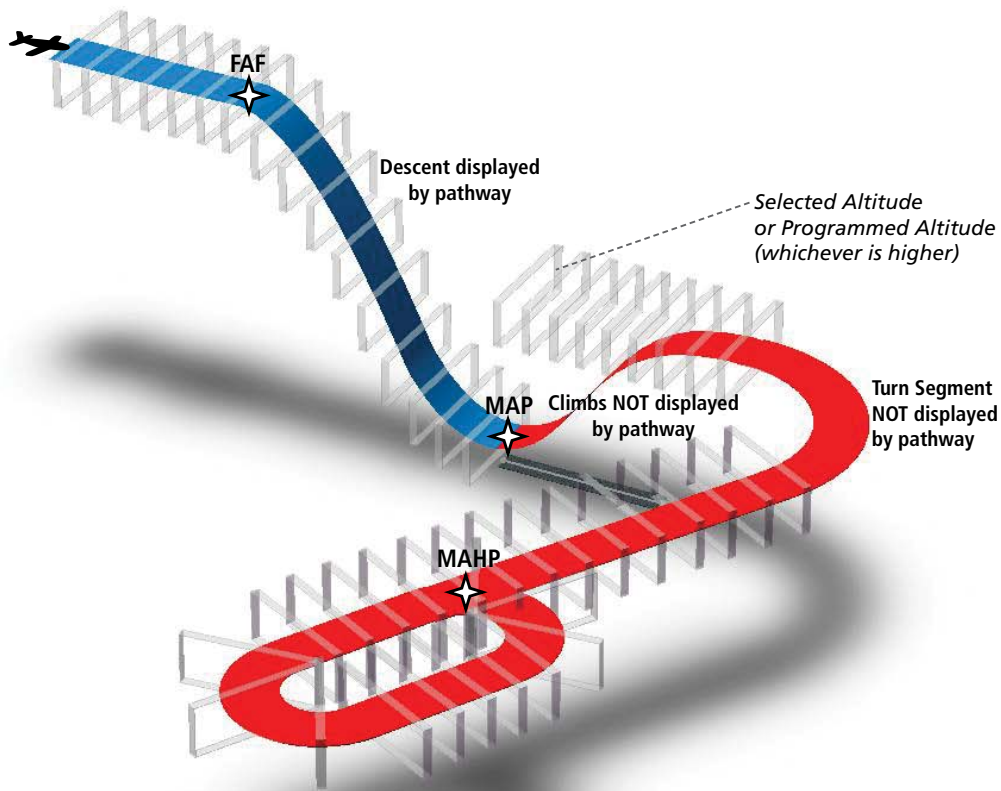

Figure 8-6 SVS Pathways, Approach, Missed Approach, and Holding

SYSTEM OVERVIEW

FLIGHT INSTRUMENTS

EIS

AUDIO PANEL & CNS

FLIGHT MANAGEMENT

HAZARD AVOIDANCE

AFCS

ADDITIONAL FEATURES

APPENDICES

INDEX

FLIGHT PATH MARKER

The Flight Path Marker (FPM), also known as a Velocity Vector, is displayed on the PFD at groundspeeds above 30 knots. The FPM depicts the approximate projected path of the aircraft accounting for wind speed and direction relative to the three-dimensional terrain display.

The FPM is always available when the Synthetic Terrain feature is in operation. The FPM represents the direction of the flight path as it relates to the terrain and obstacles on the display, while the airplane symbol represents the aircraft heading.

The FPM works in conjunction with the Pathways feature to assist the pilot in maintaining desired altitudes and direction when navigating a flight plan. When on course and altitude the FPM is aligned inside the pathway boxes as shown (Figure 8-7).

The FPM may also be used to identify a possible conflict with the aircraft flight path and distant terrain or obstacles. Displayed terrain or obstacles in the aircraft's flight path extending above the FPM could indicate a potential conflict, even before an alert is issued by TAWS. However, decisions regarding terrain and/or obstacle avoidance should not be made using only the FPM.



Figure 8-7 Flight Path Marker and Pathways

ZERO PITCH LINE

The Zero Pitch Line is drawn completely across the display and represents the aircraft attitude with respect to the horizon. It may not align with the terrain horizon, particularly when the terrain is mountainous or when the aircraft is flown at high altitudes.

RUNWAYS

WARNING: Do not use SVS runway depiction as the sole means for determining the proximity of the aircraft to the runway or for maintaining the proper approach path angle during landing.

NOTE: Not all airports have runways with endpoint data in the database, therefore, these runways are not displayed.

Runway data provides improved awareness of runway location with respect to the surrounding terrain. All runway thresholds are depicted at their respective elevations as defined in the database. In some situations, where threshold elevations differ significantly, crossing runways may appear to be layered. As runways are displayed, those within 45 degrees of the aircraft heading are displayed in white. Other runways will be gray in color. When an approach for a specific runway is active, that runway will appear brighter and be outlined with a white box, regardless of the runway orientation as related to aircraft heading. As the aircraft gets closer to the runway, more detail such as runway numbers and centerlines will be displayed.



Figure 8-9 Airport Runways

TERRAIN-SVS AND TAWS ALERTING

Terrain alerting on the synthetic terrain display is triggered by Forward-looking Terrain Avoidance (FLTA) alerts, and corresponds to the red and yellow X symbols on the Inset Map and MFD map displays. For more detailed information regarding Terrain-SVS and TAWS, refer to the Hazard Avoidance Section.

In some instances, a terrain or obstacle alert may be issued with no conflict shading displayed on the synthetic terrain. In these cases, the conflict is outside the SVS field of view to the left or right of the aircraft.

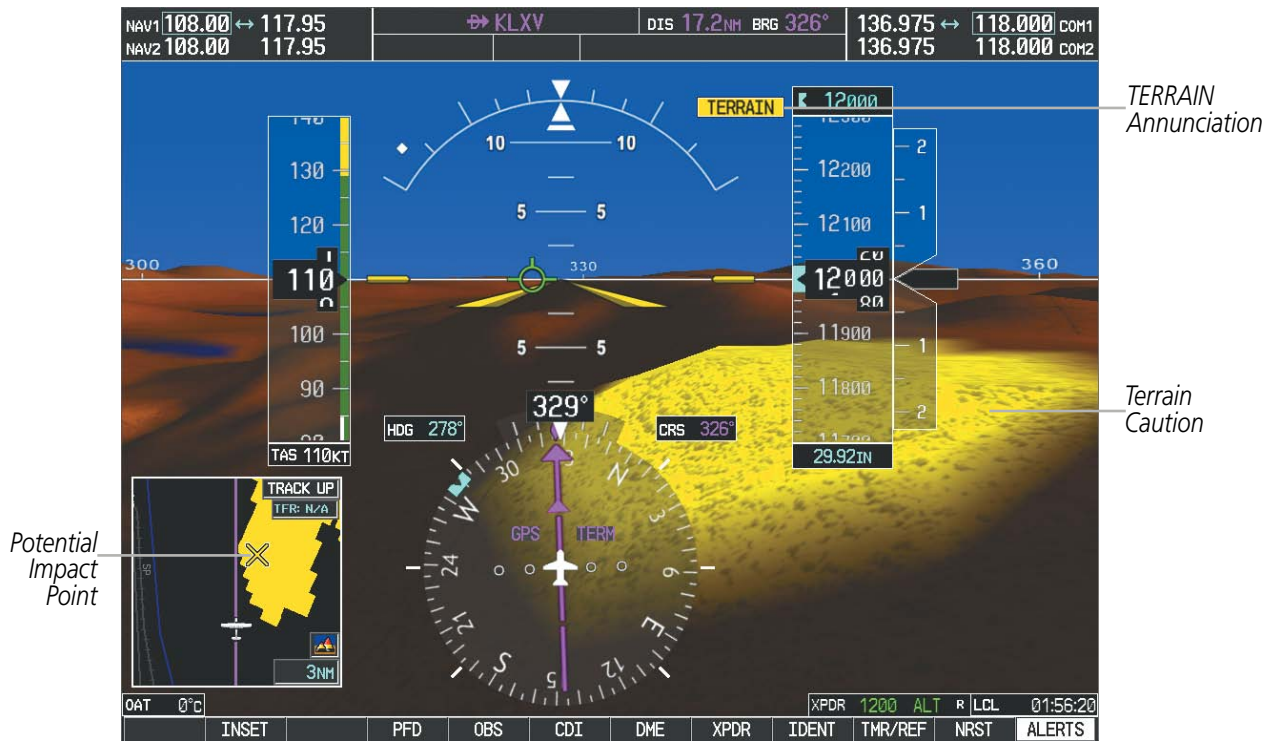

Figure 8-10 Terrain Alert

Obstacles are represented on the synthetic terrain display by standard two-dimensional tower symbols found on the Inset map and MFD maps and charts. Obstacle symbols appear in the perspective view with relative height above terrain and distance from the aircraft. Unlike the Inset map and MFD moving map display, obstacles on the synthetic terrain display do not change colors to warn of potential conflict with the aircraft's flight path until the obstacle is associated with an actual FLTA alert. Obstacles greater than 1000 feet below the aircraft altitude are not shown. Obstacles are shown behind the airspeed and altitude displays.



Figure 8-11 Obstacle

FIELD OF VIEW

The PFD field of view can be represented on the MFD Navigation Map Page. Two dashed lines forming a V-shape in front of the aircraft symbol on the map, represent the forward viewing area shown on the PFD.

Configuring field of view:

- 1) While viewing the Navigation Map Page, press the **MENU** Key to display the PAGE MENU.
- 2) Turn the large **FMS** Knob to highlight Map Setup and press the **ENT** Key.



Navigation Map Page OPTIONS Menu Map Setup Menu, Map Group, Field of View Option

Figure 8-12 Option Menus

- 3) Turn the **FMS** Knob to select the Map Group and press the **ENT** Key.
- 4) Turn the large **FMS** Knob to scroll through the Map Group options to FIELD OF VIEW.
- 5) Turn the small **FMS** Knob to select On or Off.
- 6) Press the **FMS** Knob to return to the Navigation Map Page.

The following figure compares the PFD forward looking depiction with the MFD plan view and FIELD OF VIEW turned on.

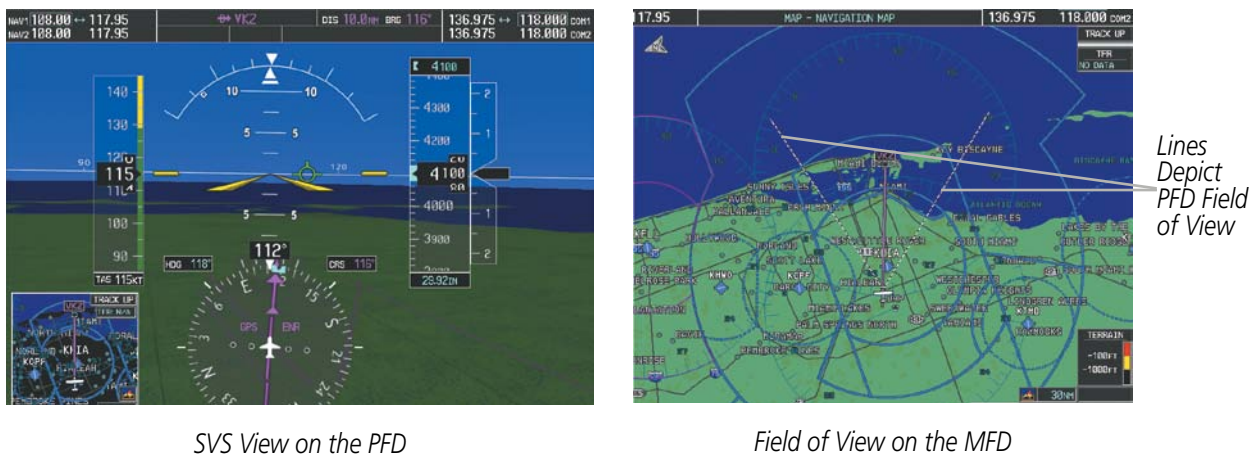

Figure 8-13 PFD and MFD Field of View Comparison

8.2 SAFETAXI

SafeTaxi is an enhanced feature that gives greater map detail when viewing airports at close range. The maximum map ranges for enhanced detail are pilot configurable. When viewing at ranges close enough to show the airport detail, the map reveals taxiways with identifying letters/numbers, airport Hot Spots, and airport landmarks including ramps, buildings, control towers, and other prominent features. Resolution is greater at lower map ranges. When the MFD display is within the SafeTaxi ranges, the airplane symbol on the airport provides enhanced position awareness.

Designated Hot Spots are recognized at airports with many intersecting taxiways and runways, and/or complex ramp areas. Airport Hot Spots are outlined to caution pilots of areas on an airport surface where positional awareness confusion or runway incursions happen most often. Hot Spots are defined with a magenta circle or outline around the region of possible confusion.

Any map page that displays the navigation view can also show the SafeTaxi airport layout within the maximum configured range. The following is a list of pages where the SafeTaxi feature can be seen:

- Navigation Map Page
- Inset Map (PFD)
- Weather Datalink Page
- Airport Information Page
- Intersection Information Page
- NDB Information Page
- VOR Information Page
- User Waypoint Information Page
- Trip Planning Page
- Nearest Pages
- Active and Stored Flight Plan Pages

During ground operations the aircraft's position is displayed in reference to taxiways, runways, and airport features. In the example shown, the aircraft is on taxiway Bravo approaching the High Alert Intersection boundary on KSFO airport. Airport Hot Spots are outlined in magenta. When panning over the airport, features such as runway holding lines and taxiways are shown at the cursor.

SYSTEM OVERVIEW
 FLIGHT INSTRUMENTS
 EIS
 AUDIO PANEL & CNS
 FLIGHT MANAGEMENT
 HAZARD AVOIDANCE
 AFCS
 ADDITIONAL FEATURES
 APPENDICES
 INDEX

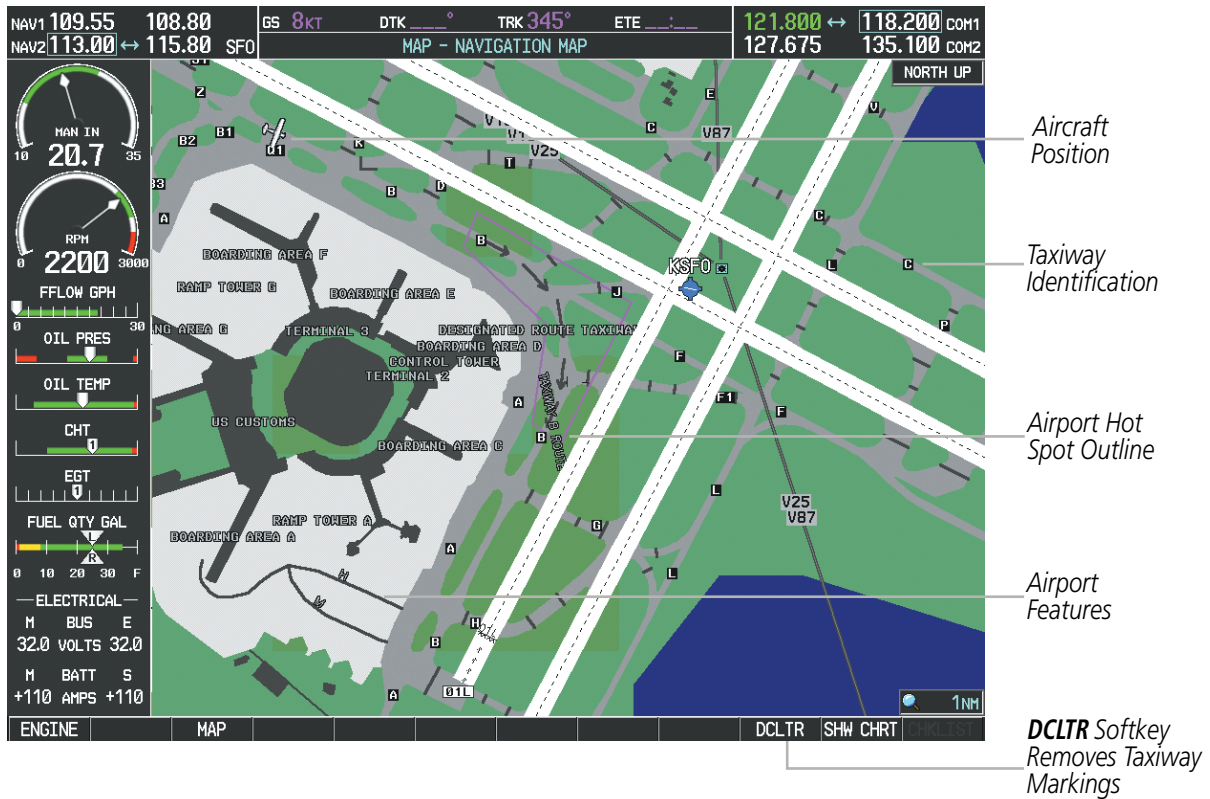

Figure 8-14 SafeTaxi Depiction on the Navigation Map Page

The **DCLTR** Softkey (declutter) label advances to DCLTR-1, DCLTR -2, and DCLTR-3 each time the softkey is pressed for easy recognition of decluttering level. Pressing the **DCLTR** Softkey removes the taxiway markings and airport feature labels. Pressing the **DCLTR-1** Softkey removes VOR station ID, the VOR symbol, and intersection names if within the airport plan view. Pressing the **DCLTR-2** Softkey removes the airport runway layout, unless the airport in view is part of an active route structure. Pressing the **DCLTR-3** Softkey cycles back to the original map detail. Refer to Map Declutter Levels in the Flight Management Section.

Configuring SafeTaxi range:

- 1) While viewing the Navigation Map Page, press the **MENU** Key to display the PAGE MENU.
- 2) Turn the large **FMS** Knob to highlight the Map Setup Menu Option and press the **ENT** Key.

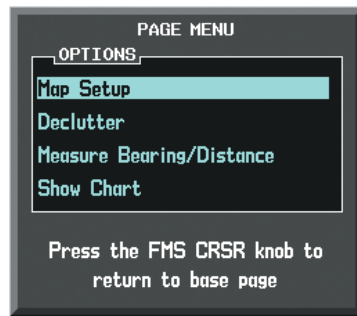

Figure 8-15 Navigation Map PAGE MENU, Map Setup Option

- 3) Turn the **FMS** Knob to select the Aviation Group and press the **ENT** Key.
- 4) Turn the large **FMS** Knob to scroll through the Aviation Group options to SAFETAXI.
- 5) Turn the small **FMS** Knob to display the range of distances.
- 6) Turn either **FMS** Knob to select the desired distance for maximum SafeTaxi display range.
- 7) Press the **ENT** Key to complete the selection.
- 8) Press the **FMS** Knob to return to the Navigation Map Page.

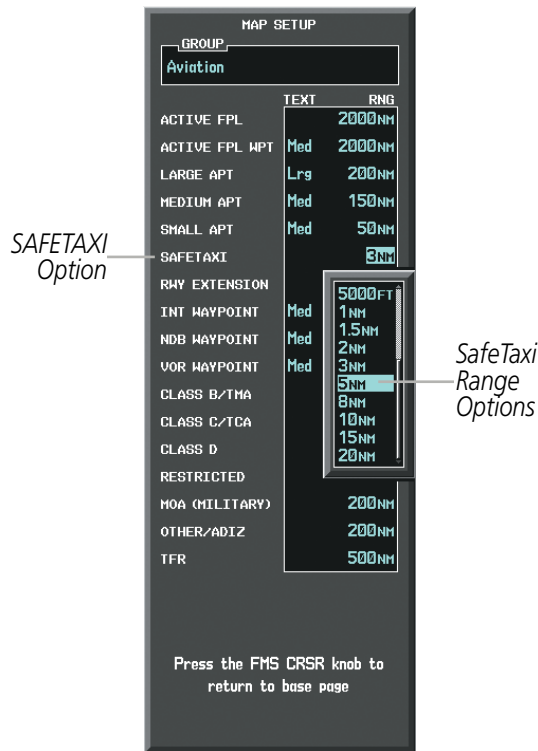

Figure 8-16 MAP SETUP Menu, Aviation Group, SAFETAXI Range Options

SAFETAXI CYCLE NUMBER AND REVISION

SafeTaxi database is revised every 56 days. SafeTaxi is always available for use after the expiration date. When turning on the system, the Power-up Page indicates whether the databases are current, out of date, or not available.

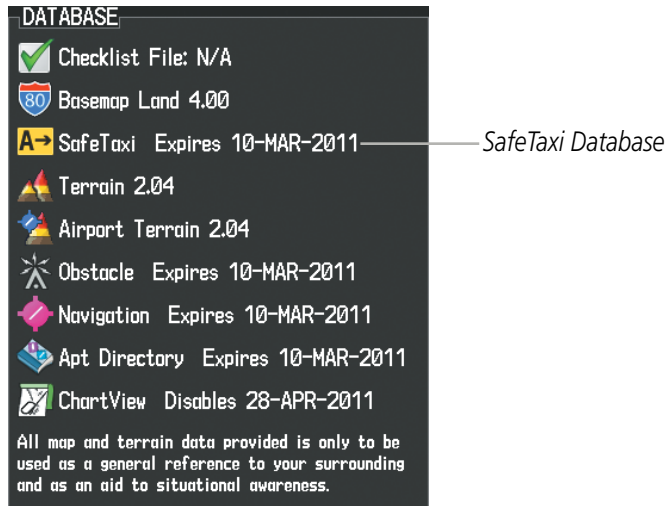

Figure 8-17 Power-up Page, SafeTaxi Database

Power-up Page Display	Definition
	Normal operation. SafeTaxi database is valid and within current cycle.
	SafeTaxi database has expired.
	Database card contains no SafeTaxi data.

Table 8-1 SafeTaxi Annunciation Definitions

The SafeTaxi Region, Version, Cycle, Effective date and Expires date of the database cycle can also be found on the AUX - System Status page, as seen in Figure 8-18.

Select the **MFD1 DB** Softkey to place the cursor in the DATABASE window. Scroll through the listed information by turning the **FMS** Knob or pressing the **ENT** Key until the SafeTaxi database information is shown.

The SafeTaxi database cycle number shown in the figure, 11S1, is deciphered as follows:

11 – Indicates the year 2011

S – Indicates the data is for SafeTaxi

1 – Indicates the first issue of the SafeTaxi database for the year

The SafeTaxi EFFECTIVE date 13–JAN–11 is the beginning date for the current database cycle. SafeTaxi EXPIRES date 10–MAR–11 is the revision date for the next database cycle.

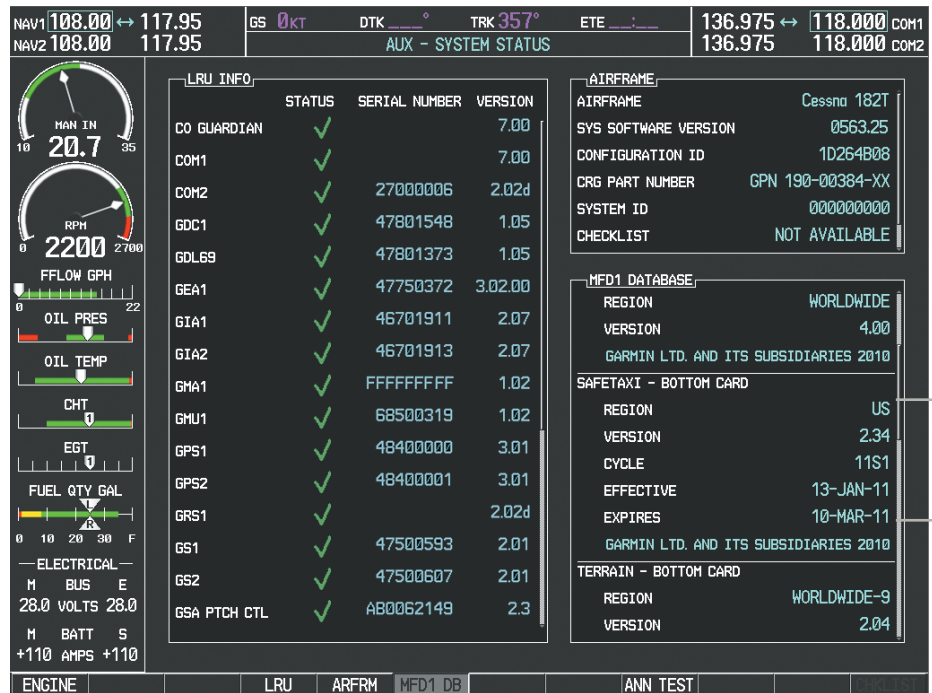

Figure 8-18 AUX – System Status Page, SafeTaxi Current Information

SafeTaxi information appears in blue and yellow text. The EFFECTIVE date appears in blue when data is current and in yellow when the current date is before the effective date. The EXPIRES date appears in blue when data is current and in yellow when expired (Figures 8-18 and 8-19). NOT AVAILABLE appears in blue in the REGION field if SafeTaxi data is not available on the database card (Figure 8-19). An expired SafeTaxi database is not disabled and will continue to function indefinitely.

Select the **MFD1 DB** Softkey a second time. The softkey label will change to **PFDI DB**. The DATABASE window will now be displaying database information for PFD1. As before, scroll through the listed information by turning the **FMS** Knob or pressing the **ENT** Key until the SafeTaxi database information is shown.

Refer to Updating Garmin Databases in Appendix B for instructions on revising the SafeTaxi database.

Figure 8-19 illustrates possible SafeTaxi database conditions that may appear on the AUX - System Status Page. The EFFECTIVE date is the beginning date for this database cycle. If the present date is before the effective date, the EFFECTIVE date appears in yellow and the EXPIRES date appears in blue. The EXPIRES date is the revision date for the next database cycle. NOT AVAILABLE indicates that SafeTaxi is not available on the database card or no database card is inserted.

MFD1 DATABASE	MFD1 DATABASE	MFD1 DATABASE
REGION WORLDWIDE	REGION WORLDWIDE	REGION WORLDWIDE
VERSION 4.00	VERSION 4.00	VERSION 4.00
GARMIN LTD. AND ITS SUBSIDIARIES 2010	GARMIN LTD. AND ITS SUBSIDIARIES 2010	GARMIN LTD. AND ITS SUBSIDIARIES 2010
SAFETAXI - BOTTOM CARD	SAFETAXI - BOTTOM CARD	SAFETAXI - UNKNOWN
REGION US	REGION US	REGION NOT AVAILABLE
VERSION 2.34	VERSION 2.34	VERSION
CYCLE 11S1	CYCLE 11S1	CYCLE
EFFECTIVE 13-JAN-11	EFFECTIVE 13-JAN-11	EFFECTIVE --- -- --
EXPIRES 10-MAR-11	EXPIRES 10-MAR-11	EXPIRES --- -- --
GARMIN LTD. AND ITS SUBSIDIARIES 2010	GARMIN LTD. AND ITS SUBSIDIARIES 2010	
TERRAIN - BOTTOM CARD	TERRAIN - BOTTOM CARD	TERRAIN - BOTTOM CARD
REGION WORLDWIDE-9	REGION WORLDWIDE-9	REGION WORLDWIDE-9
VERSION 2.04	VERSION 2.04	VERSION 2.04

Current Date is before Effective Date

SafeTaxi Database has Expired

SafeTaxi Database Not Installed

Figure 8-19 AUX – System Status Page, SafeTaxi Database Status

- SYSTEM OVERVIEW
- FLIGHT INSTRUMENTS
- EIS
- AUDIO PANEL & CNS
- FLIGHT MANAGEMENT
- HAZARD AVOIDANCE
- AFCS
- ADDITIONAL FEATURES
- APPENDICES
- INDEX

8.3 CHARTVIEW (OPTIONAL)

ChartView resembles the paper version of Jeppesen terminal procedures charts. The charts are displayed in full color with high-resolution. The MFD depiction shows the aircraft position on the moving map in the plan view of approach charts and on airport diagrams. Airport Hot Spots are outlined in magenta.

The ChartView database subscription is available from Jeppesen, Inc. Available data includes:

- Arrivals (STAR)
- Departure Procedures (DP)
- Approaches
- Airport Diagrams
- NOTAMs

CHARTVIEW SOFTKEYS

ChartView functions are displayed on three levels of softkeys. While on the Navigation Map Page, Nearest Airports Page, or Flight Plan Page, pressing the **SHW CHRT** Softkey displays the available terminal chart and advances to the chart selection level of softkeys: **CHRT OPT**, **CHRT**, **INFO-1**, **DP**, **STAR**, **APR**, **WX**, **NOTAM**, and **GO BACK**. The chart selection softkeys shown below appear on the Airport Information Page.

Pressing the **GO BACK** Softkey reverts to the top level softkeys and previous page.

Pressing the **CHRT OPT** Softkey advances to the next level of softkeys: **ALL**, **HEADER**, **PLAN**, **PROFILE**, **MINIMUMS**, **FIT WDTN**, **FULL SCN**, and **BACK**.

While viewing the **CHRT OPT** Softkeys, after 45 seconds of softkey inactivity, the system reverts to the chart selection softkeys.

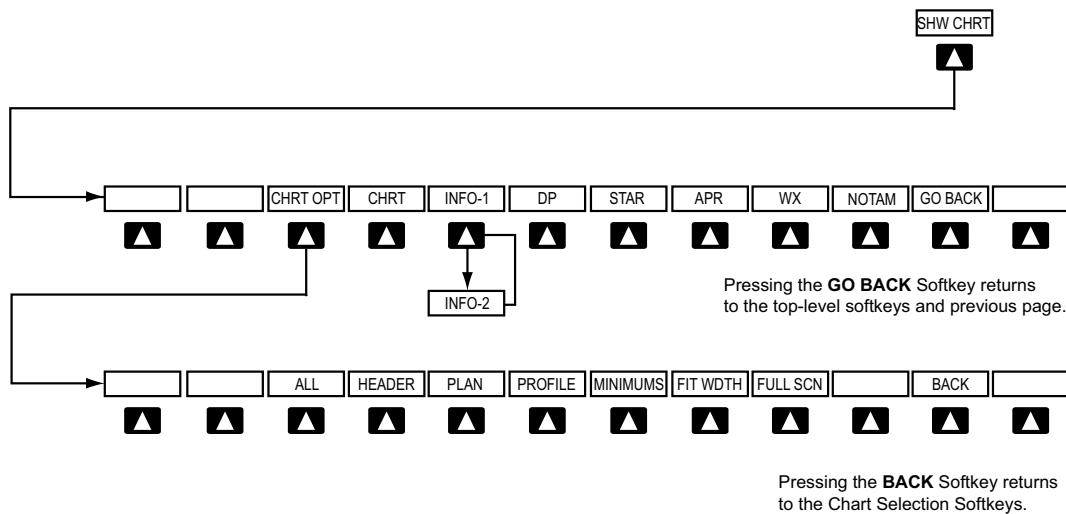

Figure 8-20 ChartView SHW CHRT, Chart Selection, and Chart Option Softkeys

TERMINAL PROCEDURES CHARTS

Selecting Terminal Procedures Charts:

While viewing the Navigation Map Page, Nearest Airport Page, or Flight Plan Page, press the **SHW CHRT** Softkey.

Or:

- 1) Press the **MENU** Key to display the PAGE MENU.
- 2) Turn the large **FMS** Knob to scroll through the OPTIONS Menu to Show Chart.
- 3) Press the **ENT** Key to display the chart.

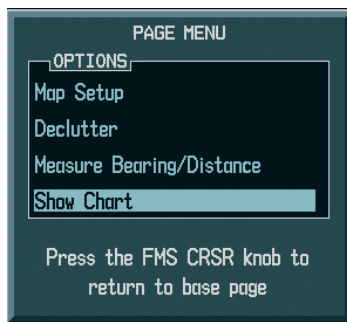

Navigation Map Page OPTIONS Menu



Waypoint Airport Information Page OPTIONS Menu

Figure 8-21 Option Menus

When no terminal procedure chart is available for the nearest airport or the selected airport, the banner **CHART NOT AVAILABLE** appears on the screen. The **CHART NOT AVAILABLE** banner does not refer to the Jeppesen subscription, but rather the availability of a particular airport chart selection or procedure for a selected airport.



Figure 8-22 Chart Not Available Banner

If there is a problem in rendering the data (such as a data error or a failure of an individual chart), the banner **UNABLE TO DISPLAY CHART** is then displayed.



Figure 8-23 Unable To Display Chart Banner

When a chart is not available by pressing the **SHW CHRT** Softkey or selecting a Page Menu Option, charts may be obtained for other airports from the WPT Pages or Flight Plan Pages.

If a chart is available for the destination airport, or the airport selected in the active flight plan, the chart appears on the screen. When no flight plan is active, or when not flying to a direct-to destination, pressing the **SHW CHRT** Softkey displays the chart for the nearest airport, if available.

The chart shown is one associated with the WPT – Airport Information page. Usually this is the airport runway diagram. Where no runway diagram exists, but Take Off Minimums or Alternate Minimums are available, that page appears. If Airport Information pages are unavailable, the Approach Chart for the airport is shown.

Selecting a chart:

- 1) While viewing the Navigation Map Page, Flight Plan Page, or Nearest Airports Page, press the **SHW CHRT** Softkey. The airport diagram or approach chart is displayed on the Airport Information Page.
- 2) Press the **FMS** Knob to activate the cursor.
- 3) Turn the large **FMS** Knob to select either the Airport Identifier Box or the Approach Box. (Press the **APR** Softkey if the Approach Box is not currently shown).
- 4) Turn the small and large **FMS** Knob to enter the desired airport identifier.
- 5) Press the **ENT** Key to complete the airport selection.
- 6) Turn the large **FMS** Knob to select the Approach Box.
- 7) Turn the small **FMS** Knob to show the approach chart selection choices.
- 8) Turn either **FMS** Knob to scroll through the available charts.
- 9) Press the **ENT** Key to complete the chart selection.

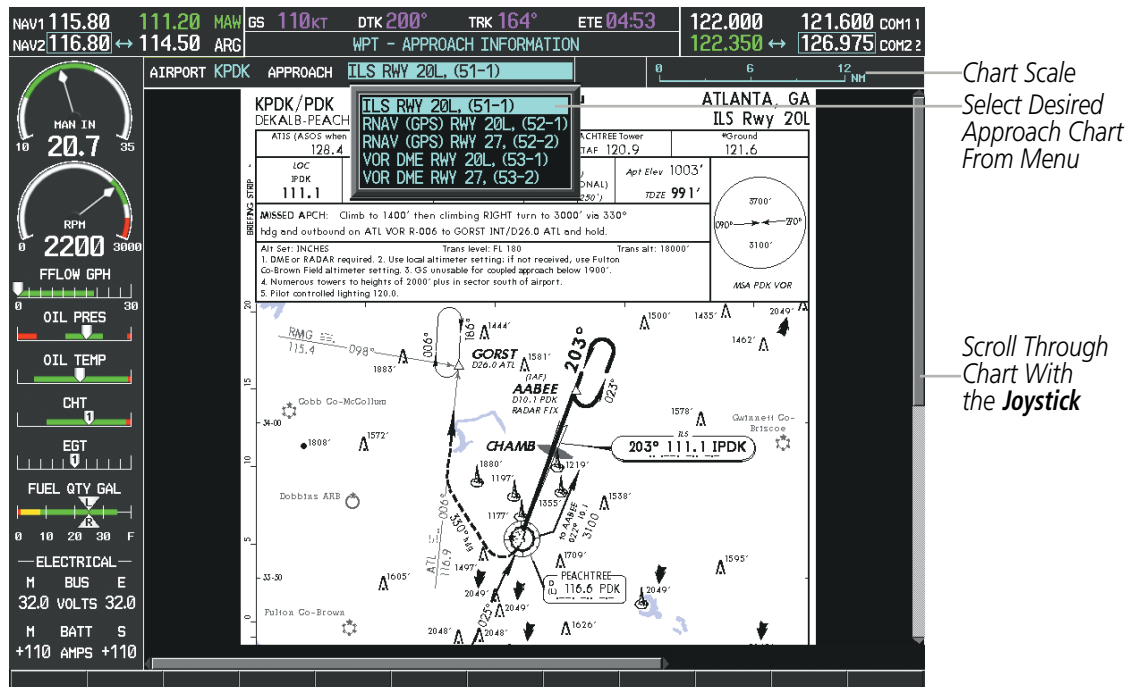

Figure 8-24 Approach Information Page, Chart Selection

SYSTEM OVERVIEW

FLIGHT INSTRUMENTS

EIS

AUDIO PANEL & CNS

FLIGHT MANAGEMENT

HAZARD AVOIDANCE

AFCS

ADDITIONAL FEATURES

APPENDICES

INDEX

While the APPROACH Box is selected using the **FMS** Knob, the G1000 softkeys are blank. Once the desired chart is selected, the chart scale can be changed and the chart page can be scrolled using the **Joystick**. Pressing the **Joystick** centers the chart on the screen.

The aircraft symbol is shown on the chart only if the chart is to scale and the aircraft position is within the boundaries of the chart. The aircraft symbol is not displayed when the Aircraft Not Shown Icon appears (Figure 8-28). If the Chart Scale Box displays a banner NOT TO SCALE, the aircraft symbol is not shown. The Aircraft Not Shown Icon may appear at certain times, even if the chart is displayed to scale.

Pressing the **CHRT** Softkey switches between the ChartView diagram and the associated map in the WPT page group. In the example shown, the **CHRT** Softkey switches between the DeKalb Peachtree (KPKD) Airport Diagram and the navigation map on the WPT – Airport Information page.

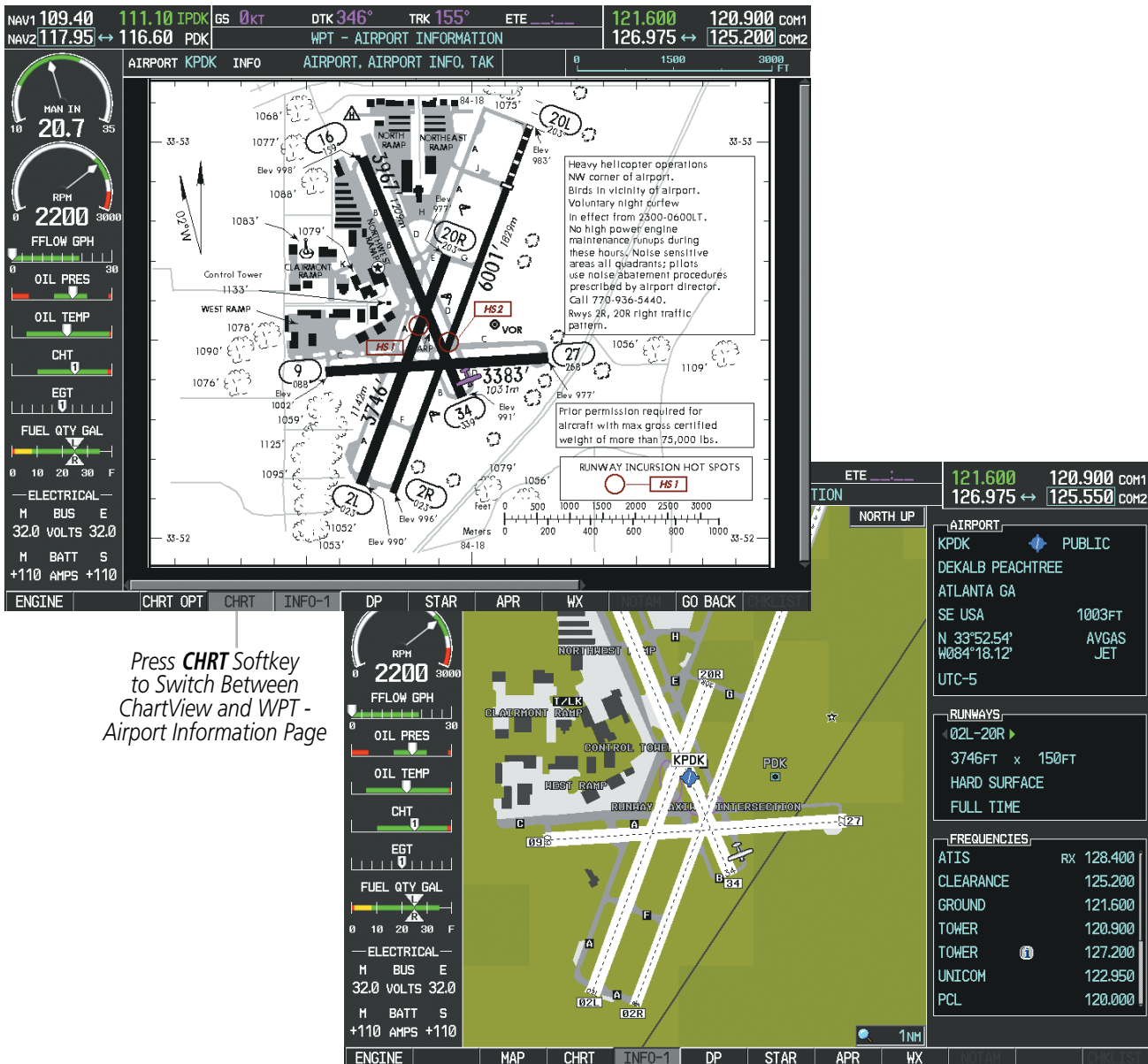

Press **CHRT** Softkey to Switch Between ChartView and WPT - Airport Information Page

Figure 8-25 CHRT Softkey, Airport Information Page

Pressing the **INFO-1** or **INFO-2** Softkey returns to the airport diagram when the view is on a different chart. If the displayed chart is the airport diagram, the **INFO-1** or **INFO-2** Softkey has no effect.

The aircraft position is shown in magenta on the ChartView diagrams when the location of the aircraft is within the chart boundaries. In the example shown, the aircraft is taxiing on Taxiway Alpha on the Charlotte, NC (KCLT) airport.

Another source for additional airport information is from the INFO Box above the chart for certain airports. This information source is not related to the **INFO-1** or **INFO-2** Softkey. When the INFO Box is selected using the **FMS** Knob, the G1000 softkeys are blank. The Charlotte, NC airport has five additional charts offering information; the Airport Diagram, Take-off Minimums, Class B Airspace, Airline Parking Gate Coordinates, and Airline Parking Gate Location. (The numbers in parentheses after the chart name are Jeppesen designators.)



Figure 8-26 Airport Information Page, INFO View, Full Screen Width

SYSTEM OVERVIEW

FLIGHT INSTRUMENTS

EIS

AUDIO PANEL & CNS

FLIGHT MANAGEMENT

HAZARD AVOIDANCE

AFCS

ADDITIONAL FEATURES

APPENDICES

INDEX

In the example shown in Figure 8-26, the Class B Chart is selected. Pressing the **ENT** Key displays the Charlotte Class B Airspace Chart (Figure 8-27).

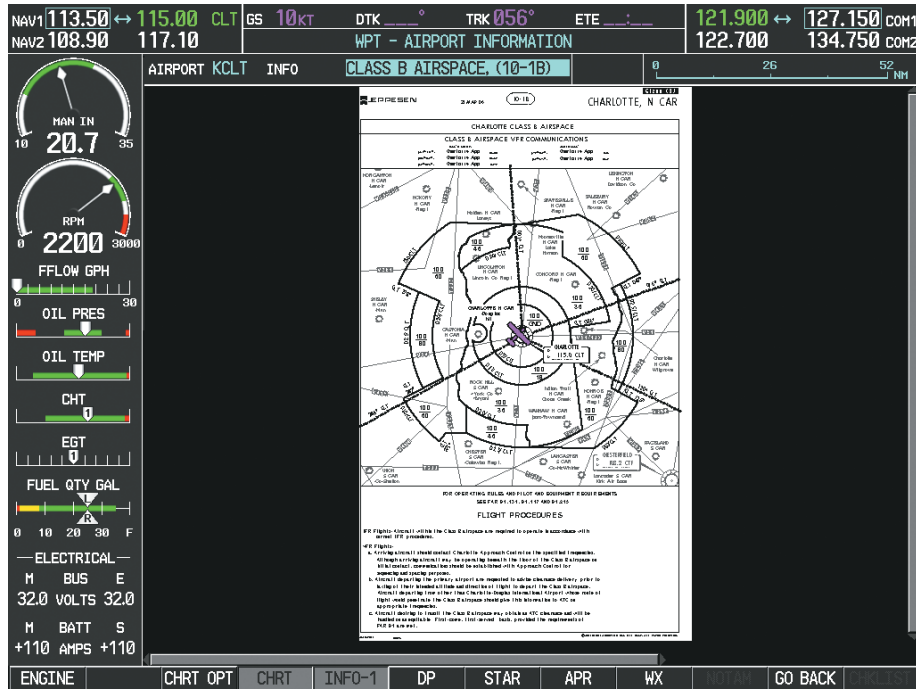

Figure 8-27 Airport Information Page, Class B Chart Selected from INFO View

Pressing the **DP** Softkey displays the Departure Procedure Chart if available.

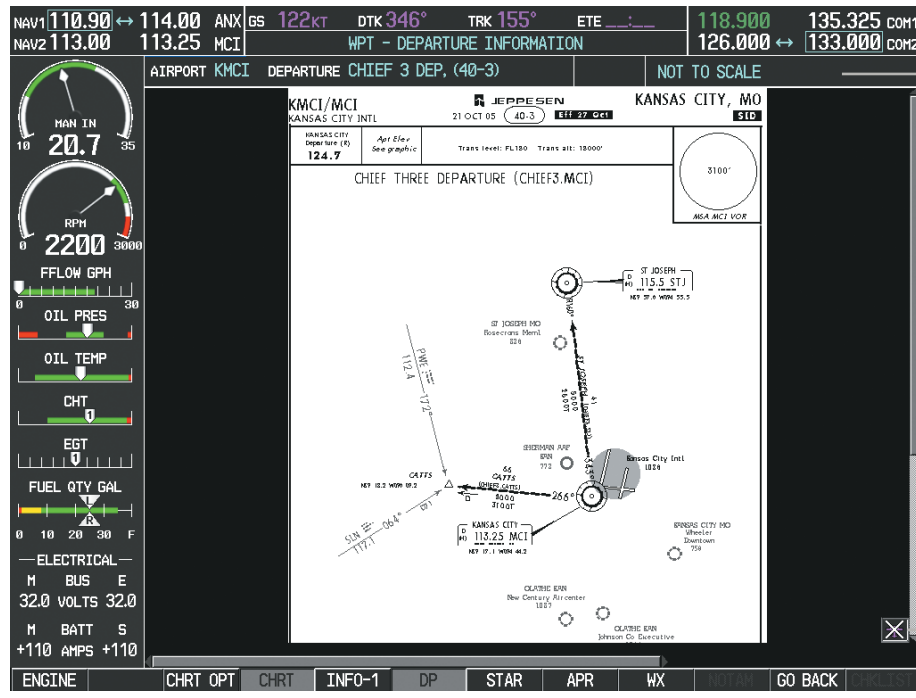

Figure 8-28 Departure Information Page

Pressing the **STAR** Softkey displays the Standard Terminal Arrival Chart if available.

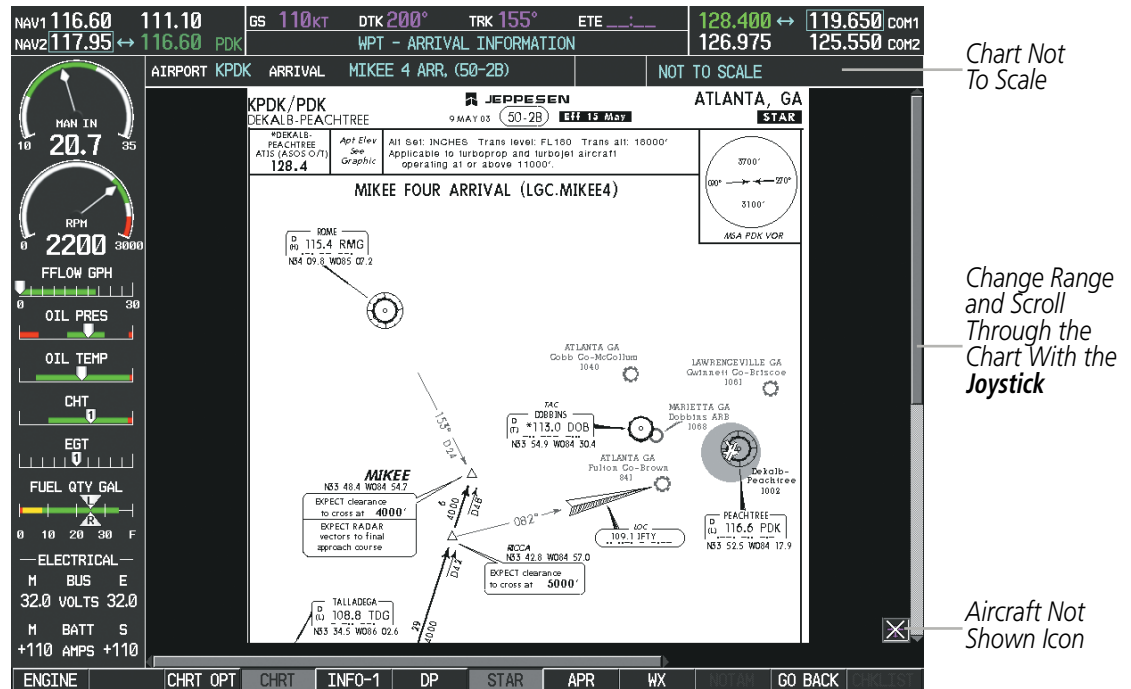

Figure 8-29 Arrival Information Page

Pressing the **APR** Softkey displays the approach chart for the airport if available.



Figure 8-30 Approach Information Page

- SYSTEM OVERVIEW
- FLIGHT INSTRUMENTS
- EIS
- AUDIO PANEL & CNS
- FLIGHT MANAGEMENT
- HAZARD AVOIDANCE
- AFCS
- ADDITIONAL FEATURES
- APPENDICES
- INDEX

Pressing the **WX** Softkey shows the airport weather frequency information, and includes weather data such as METAR and TAF from the XM Data Link Receiver, when available. Weather information is available only when an XM Data Link Receiver is installed and the XM WX Satellite Weather subscription is current.

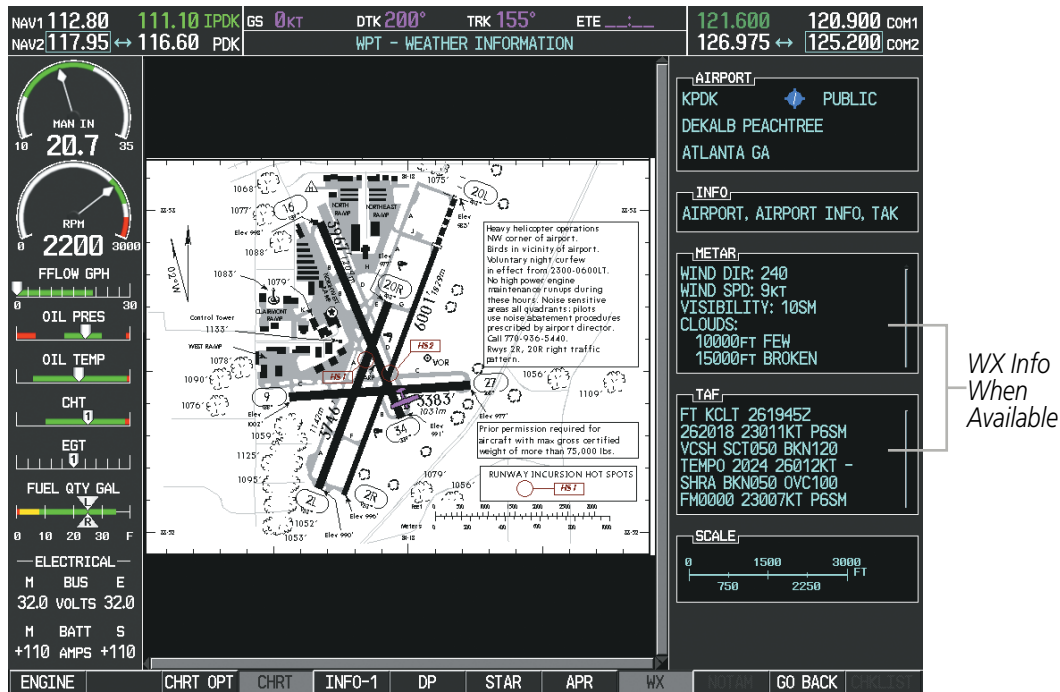
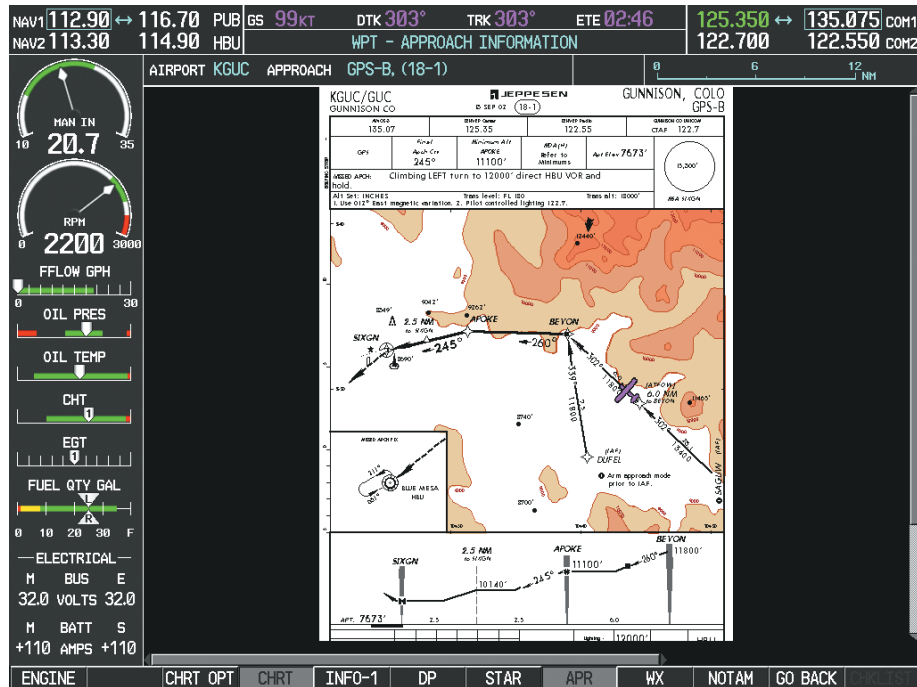

Figure 8-31 Weather Information Page

NOTE: A subdued softkey label indicates the function is disabled.

NOTE: Only NOTAMs applicable to specific information conveyed on the displayed Jeppesen chart are available when the NOTAM Softkey is selected. There may be other NOTAMs available pertaining to the flight that may not be displayed. Contact Jeppesen for more information regarding Jeppesen database-published NOTAMs.

Recent NOTAMs applicable to the current ChartView cycle are included in the ChartView database. Pressing the **NOTAM** Softkey shows the local NOTAM information for selected airports, when available. When NOTAMs are not available, the **NOTAM** Softkey label appears subdued and is disabled as shown in Figure 8-31. The **NOTAM** Softkey may appear on the Airport Information Page and all of the chart page selections.



NOTAM Softkey Appears for Selected Airports

Figure 8-32 NOTAM Softkey Highlighted

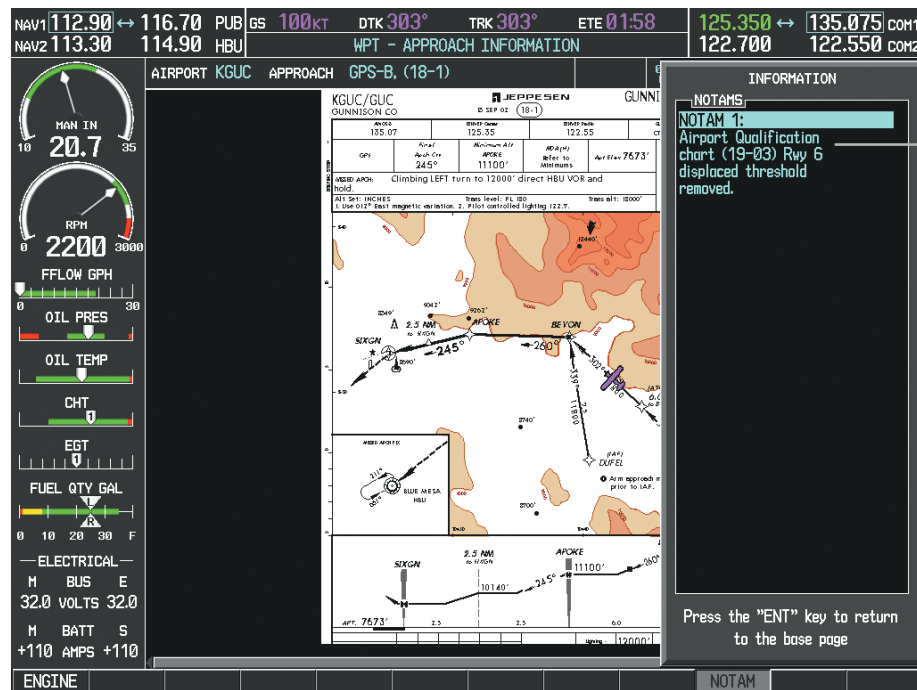

Local NOTAM on This Airport

NOTAM Softkey Selected

Figure 8-33 Airport Information Page, Local NOTAMS

Pressing the **NOTAM** Softkey again removes the NOTAMS information.

Pressing the **GO BACK** Softkey reverts to the previous page (Navigation Map Page, Nearest Pages, or Flight Plan Page).

CHART OPTIONS

Pressing the **CHRT OPT** Softkey displays the next level of softkeys, the chart options level (Figure 8-20). Pressing the **ALL** Softkey shows the complete approach chart on the screen.



Complete Chart Shown

Figure 8-34 Approach Information Page, ALL View

Pressing the **HEADER** Softkey shows the header view (approach chart briefing strip) on the screen.

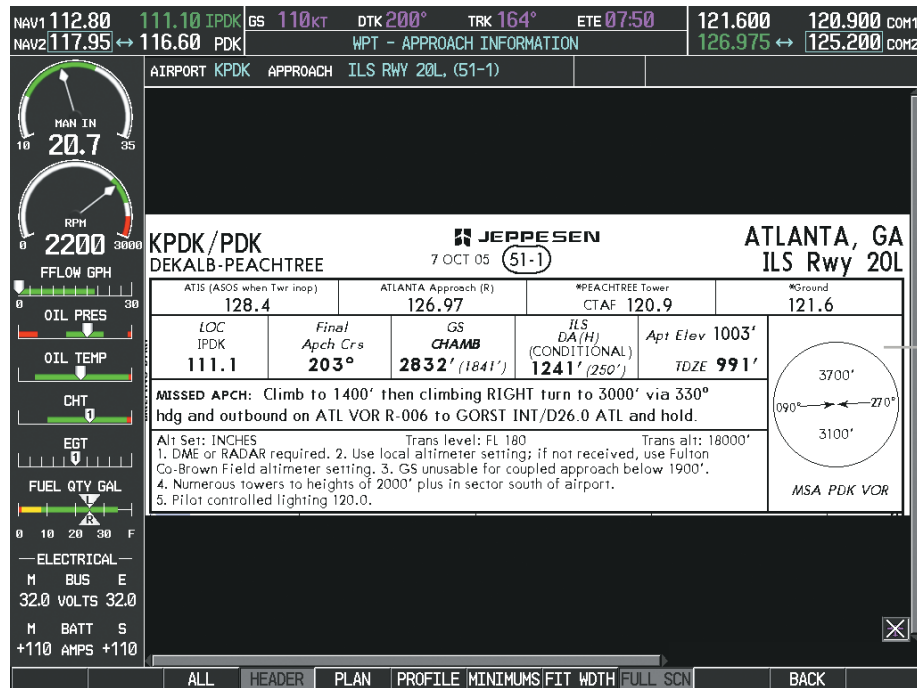

Approach Chart Briefing Strip

Figure 8-35 Approach Information Page, Header View

Pressing the **PLAN** Softkey shows the approach chart two dimensional plan view.

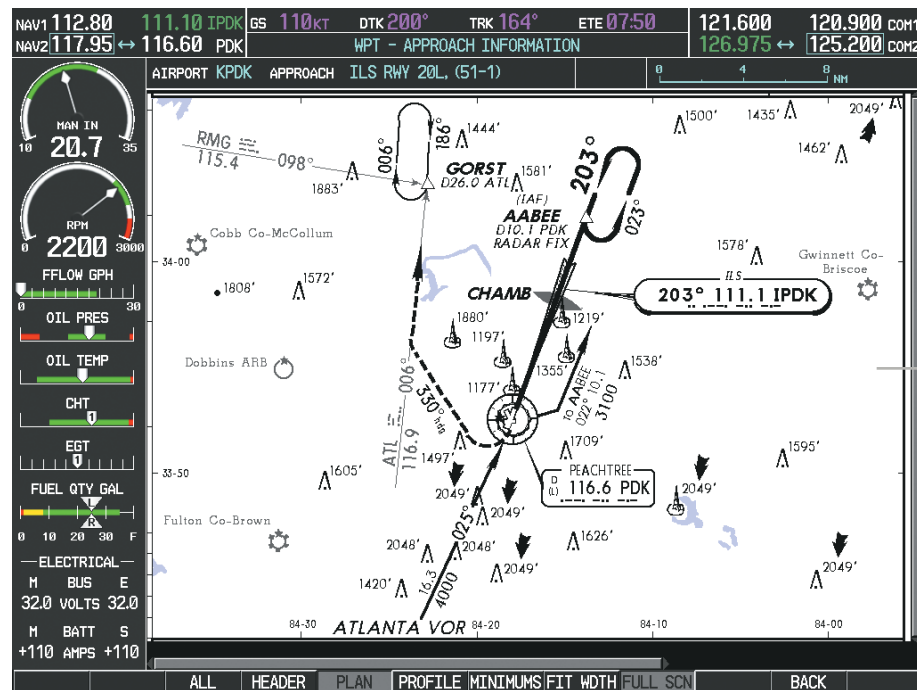

Approach Chart Plan View

Figure 8-36 Approach Information Page, Plan View

Pressing the **PROFILE** Softkey displays the approach chart descent profile strip.

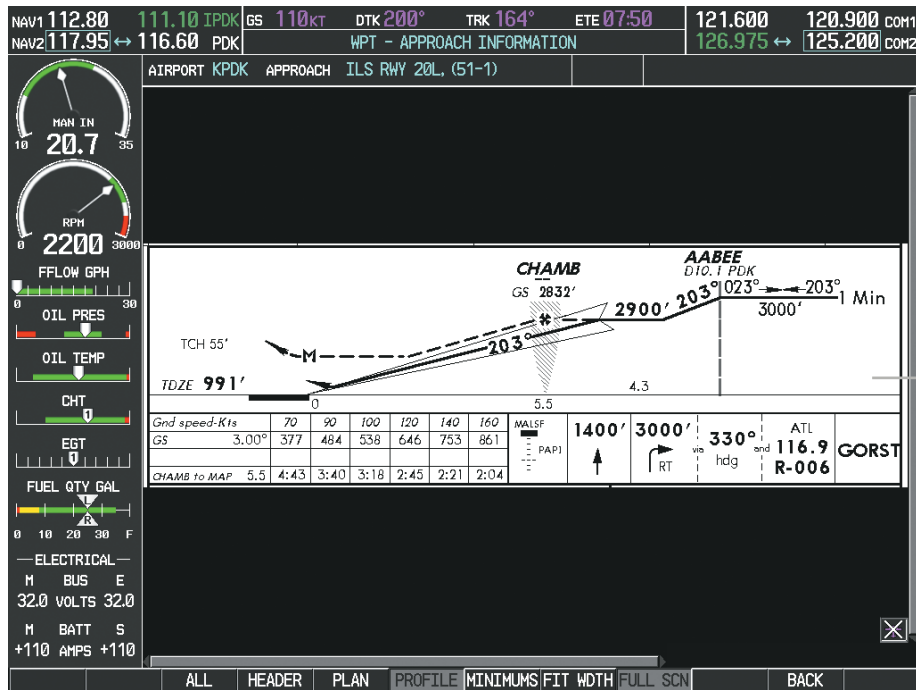

Approach Chart Descent Profile Strip

Figure 8-37 Approach Information Page, Profile View, Full Screen Width

Pressing the **MINIMUMS** Softkey displays the minimum descent altitude/visibility strip at the bottom of the approach chart.

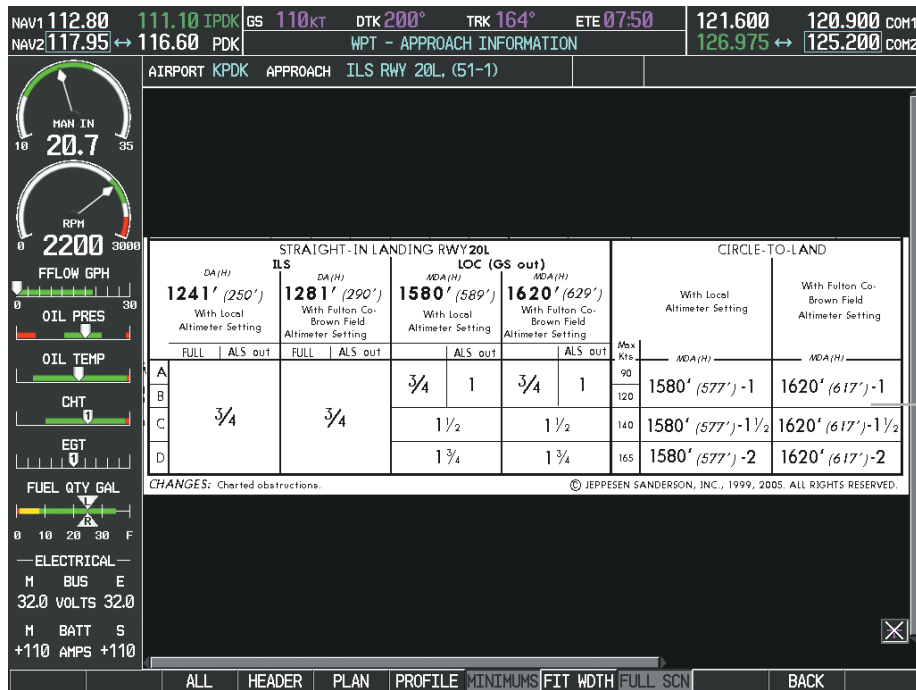

Minimum Descent Altitude/Visibility Strip

Figure 8-38 Approach Information Page, Minimums View, Full Screen Width

If the chart scale has been adjusted to view a small area of the chart, pressing the **FIT WIDTH** Softkey changes the chart size to fit the available screen width.



Press **FIT WIDTH** Softkey to Show Full Chart Width

Figure 8-39 Airport Information Page, FIT WIDTH Softkey Selected

SYSTEM OVERVIEW

FLIGHT INSTRUMENTS

EIS

AUDIO PANEL & CNS

FLIGHT MANAGEMENT

HAZARD AVOIDANCE

AFCS

ADDITIONAL FEATURES

APPENDICES

INDEX

Pressing the **FULL SCN** Softkey alternates between removing and replacing the data window to the right.

Selecting Additional Information:

- 1) While viewing the Airport Taxi Diagram, press the **FULL SCN** Softkey to display the information windows (AIRPORT, INFO).
- 2) Press the **FMS** Knob to activate the cursor.
- 3) Turn the large **FMS** Knob to highlight the AIRPORT, INFO, RUNWAYS, or FREQUENCIES Box (INFO Box shown).
- 4) Turn the small **FMS** Knob to select the INFO Box choices. If multiple choices are available, scroll to the desired choice with the large **FMS** Knob and press the **ENT** Key to complete the selection.
- 5) Press the **FMS** Knob again to deactivate the cursor.

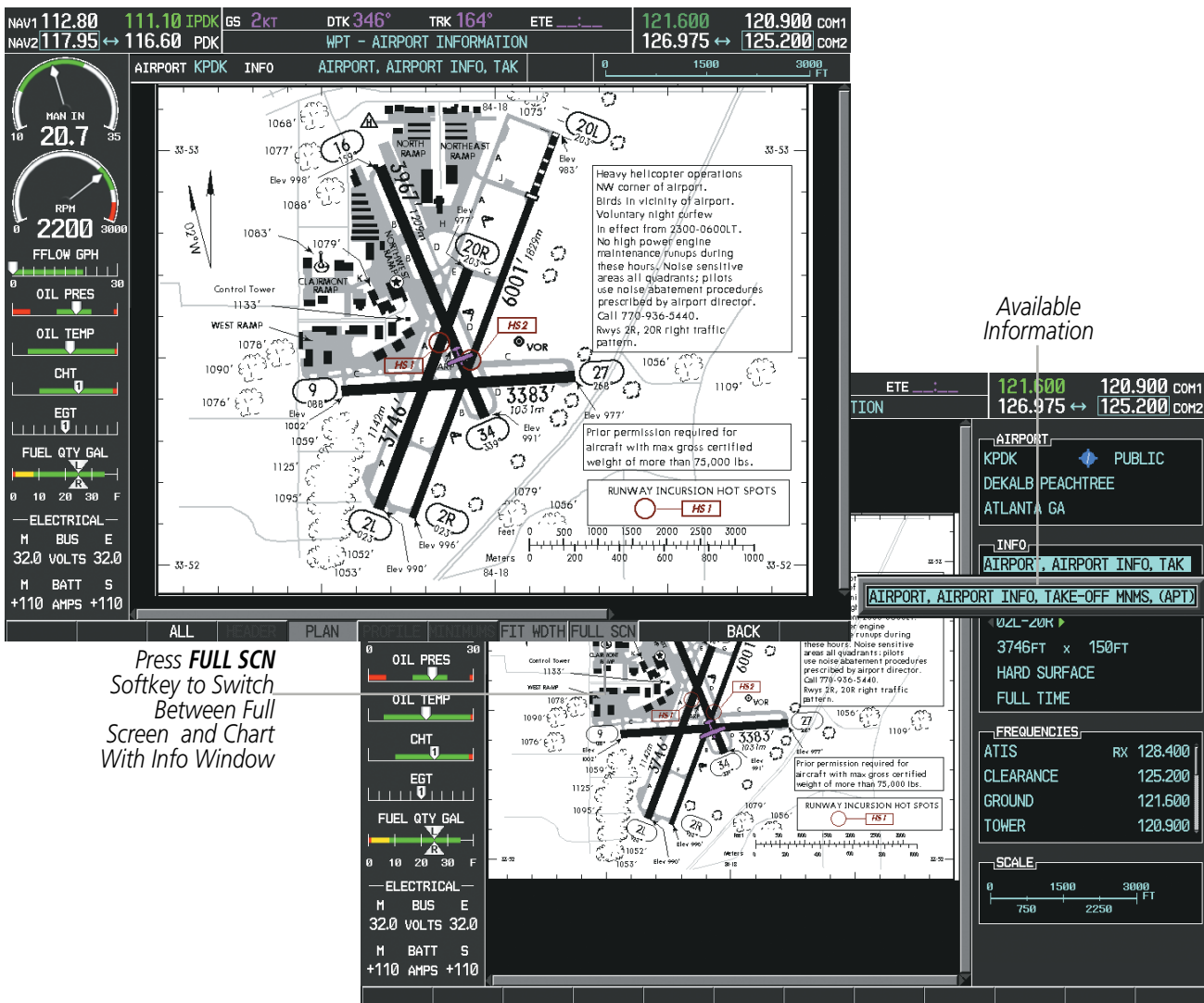

Press **FULL SCN** Softkey to Switch Between Full Screen and Chart With Info Window

Figure 8-40 Airport Information Page, Full Screen and Info Window

Pressing the **BACK** Softkey, or waiting for 45 seconds reverts to the chart selection softkeys.

The full screen view can also be selected by using the page menu option.

Selecting full screen On or Off:

- 1) While viewing a terminal chart press the **MENU** Key to display the Page Menu OPTIONS.
- 2) Turn the large **FMS** Knob to highlight the Chart Setup Menu Option and press the **ENT** Key.
- 3) Turn the large **FMS** Knob to move between the FULL SCREEN and COLOR SCHEME Options.
- 4) Turn the small **FMS** Knob to choose between the On and Off Full Screen Options.

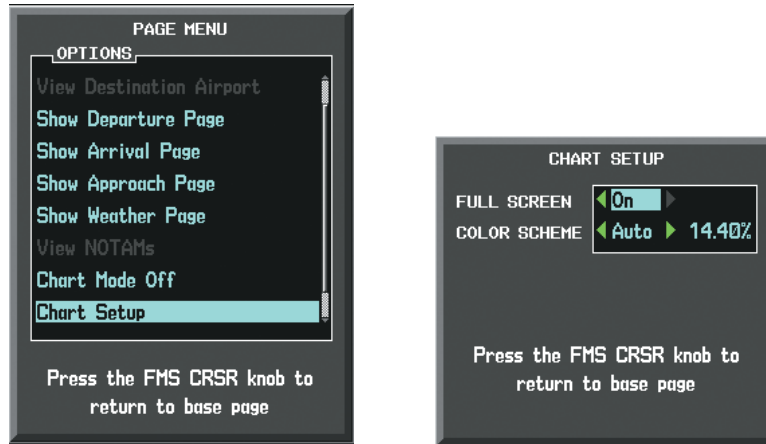

Chart Setup Option

Full Screen On/Off Selection

Figure 8-41 Page Menus

DAY/NIGHT VIEW

ChartView can be displayed on a white or black background for day or night viewing. The Day View offers a better presentation in a bright environment. The Night View gives a better presentation for viewing in a dark environment. When the CHART SETUP Box is selected the G1000 softkeys are blank.

Selecting Day, Night, or Automatic View:

- 1) While viewing a terminal chart press the **MENU** Key to display the Page Menu OPTIONS.
- 2) Turn the large **FMS** Knob to highlight the Chart Setup Menu Option and press the **ENT** Key.

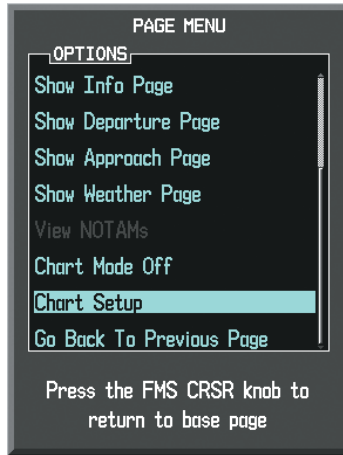

Figure 8-42 Waypoint Information Page, OPTIONS Menu

- 3) Turn the large **FMS** Knob to move to the COLOR SCHEME Option (Figure 8-43).
- 4) Turn the small **FMS** Knob to choose between Day, Auto, and Night Options.
- 5) If Auto Mode is selected, turn the large **FMS** Knob to select the percentage field. Use the small **FMS** Knob to change the percentage value. The percentage value is the day/night crossover point based on the percentage of backlighting intensity. For example, if the value is set to 15%, the day/night display changes when the display backlight reaches 15% of full brightness.

The display must be changed in order for the new setting to become active. This may be accomplished by selecting another page or changing the display range.

- 6) Press the **FMS** Knob when finished to remove the Chart Setup Menu.

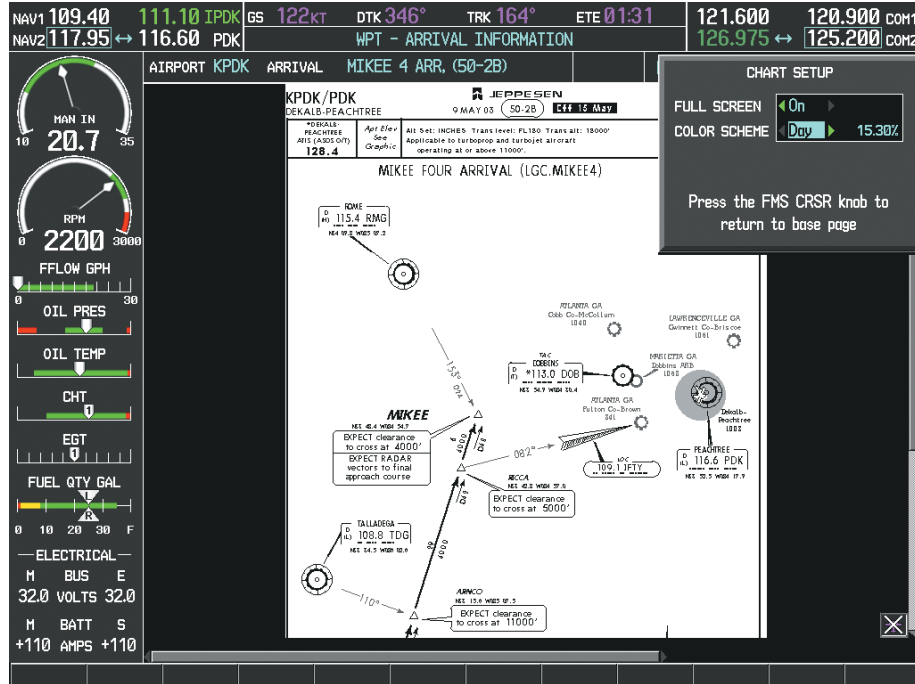

Figure 8-43 Arrival Information Page, Day View

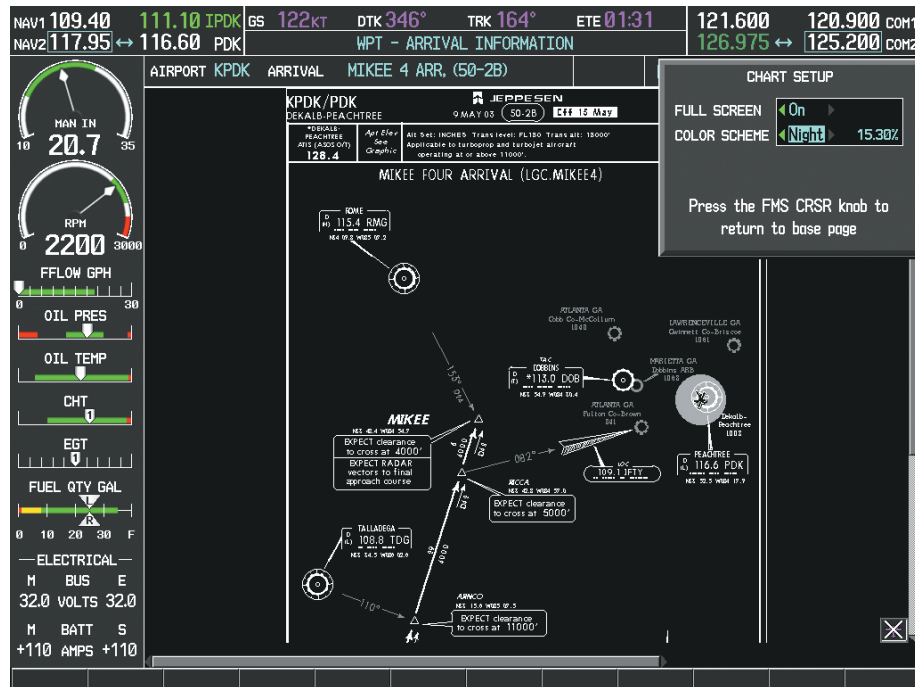

Figure 8-44 Arrival Information Page, Night View

SYSTEM OVERVIEW

FLIGHT INSTRUMENTS

EIS

AUDIO PANEL & CNS

FLIGHT MANAGEMENT

HAZARD AVOIDANCE

AFCS

ADDITIONAL FEATURES

APPENDICES

INDEX

CHARTVIEW CYCLE NUMBER AND EXPIRATION DATE

ChartView database is revised every 14 days. Charts are still viewable during a period that extends from the cycle expiration date to the disables date. ChartView is disabled 70 days after the expiration date and is no longer available for viewing. When turning on the system, the Power-up Page displays the current status of the ChartView database. See the table below for the various ChartView Power-up Page displays and the definition of each.

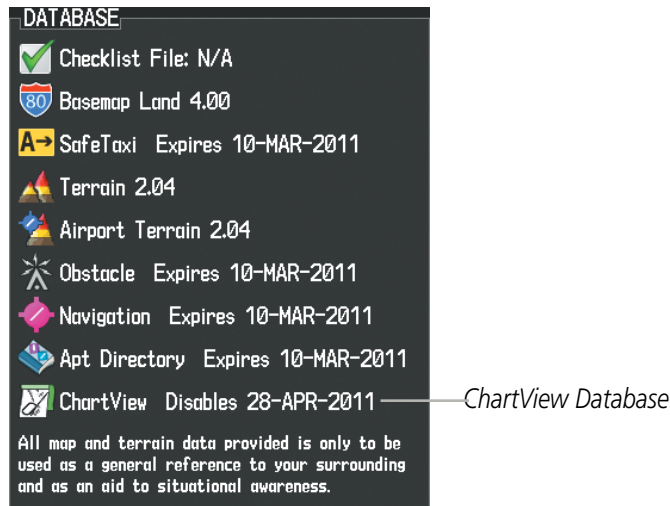



Figure 8-45 Power-up Page, ChartView Database

Power-up Page Display	Definition
[Blank Line]	Blank Line. system is not configured for ChartView. Contact a Garmin-authorized service center for configuration.
[Chart Data: N/A]	System is configured for ChartView but no chart database is installed. Contact Jeppesen for a ChartView database.
[ChartView Disables 28-APR-2011]	Normal operation. ChartView database is valid and within current cycle.
[Chart data update available.]	ChartView database is within 1 week after expiration date. A new cycle is available for update.
[Chart data is out of date!]	ChartView database is beyond 1 week after expiration date, but still within the 70 day viewing period.
[Chart data is disabled.]	ChartView database has timed out. Database is beyond 70 days after expiration date. ChartView database is no longer available for viewing.
[Verify chart database cycle.]	System time is not available. GPS satellite data is unknown or the system has not yet locked onto satellites. Check database cycle number for effectivity.
[Verifying Chart data]	System is verifying chart database when new cycle is installed for the first time.
[Chart Data is Corrupt!]	After verifying, chart database is found to be corrupt. ChartView is not available.

Table 8-2 ChartView Power-up Page Annunciations and Definitions

The ChartView time critical information can also be found on the AUX - System Status page. The database CYCLE number, EXPIRES, and DISABLES dates of the ChartView subscription appear in either blue or yellow text. When the ChartView EXPIRES date is reached, ChartView becomes inoperative 70 days later. This is shown as the DISABLES date. When the DISABLES date is reached, charts are no longer available for viewing. The **SHW CHRT** Softkey label then appears subdued and is disabled until a revised issue of ChartView is installed.

 **NOTE:** A subdued softkey label indicates the function is disabled.

Press the **MFD1 DB** Softkey to place the cursor in the DATABASE window. Scroll through the listed information by turning the **FMS** Knob or pressing the **ENT** Key until the ChartView database information is shown.

The ChartView database cycle number shown in the figure, 1103, is deciphered as follows:

11 – Indicates the year 2011

03 – Indicates the third issue of the ChartView database for the year

The EXPIRES date 17-FEB-11 is the date that this database should be replaced with the next issue.

The DISABLES date 28-APR-11 is the date that this database becomes inoperative.

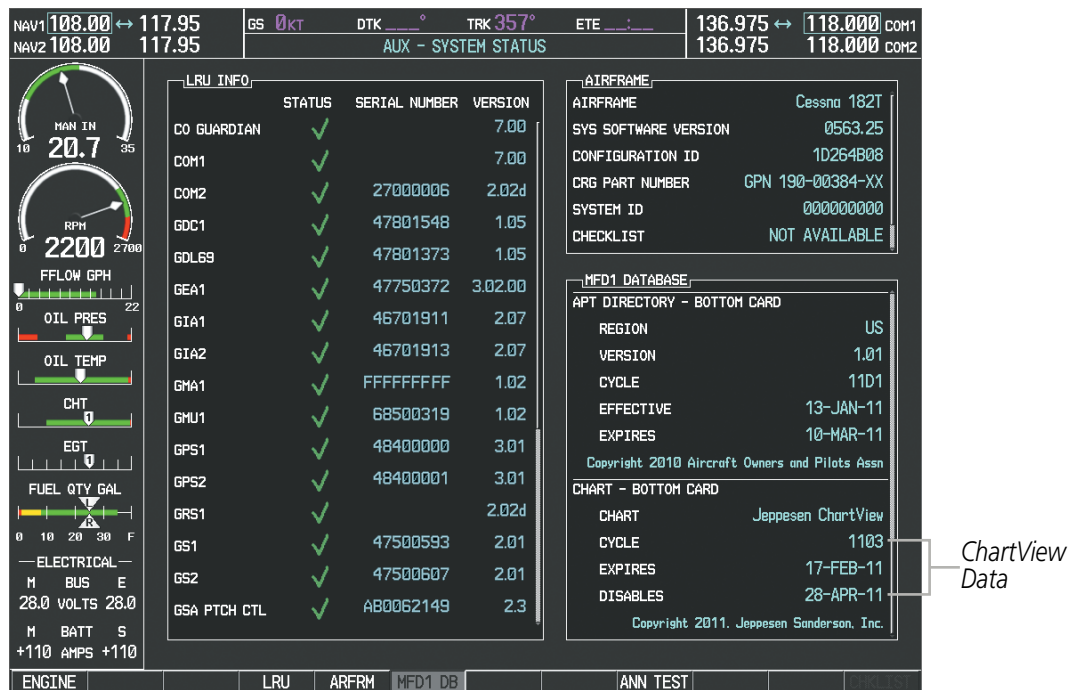

Figure 8-46 AUX – System Status Page, ChartView Current and Available

The ChartView database is provided directly from Jeppesen. Refer to Updating Jeppesen Databases in Appendix B for instructions on revising the ChartView database.

The ChartView database is obtained directly from Jeppesen. Refer to Updating Jeppesen Databases in Appendix B for instructions on revising the ChartView database.

Other possible AUX - System Status page conditions are shown in Figure 8-47. The EXPIRES date, in yellow, is the revision date for the next database cycle. The DISABLES date, in yellow, is the date that this database cycle is no longer viewable. CYCLE NOT AVAILABLE in blue, indicates no ChartView data is available on the database card or no database card is inserted.

<table border="1"> <thead> <tr><th colspan="2">MFD1 DATABASE</th></tr> </thead> <tbody> <tr><td colspan="2">APT DIRECTORY - BOTTOM CARD</td></tr> <tr><td>REGION</td><td>US</td></tr> <tr><td>VERSION</td><td>1.01</td></tr> <tr><td>CYCLE</td><td>11D1</td></tr> <tr><td>EFFECTIVE</td><td>13-JAN-11</td></tr> <tr><td>EXPIRES</td><td>10-MAR-11</td></tr> <tr><td colspan="2">Copyright 2010 Aircraft Owners and Pilots Assn</td></tr> <tr><td colspan="2">CHART - BOTTOM CARD</td></tr> <tr><td>CHART</td><td>Jeppesen ChartView</td></tr> <tr><td>CYCLE</td><td>1103</td></tr> <tr><td>EXPIRES</td><td>17-FEB-11</td></tr> <tr><td>DISABLES</td><td>28-APR-11</td></tr> <tr><td colspan="2">Copyright 2011. Jeppesen Sanderson, Inc.</td></tr> </tbody> </table>	MFD1 DATABASE		APT DIRECTORY - BOTTOM CARD		REGION	US	VERSION	1.01	CYCLE	11D1	EFFECTIVE	13-JAN-11	EXPIRES	10-MAR-11	Copyright 2010 Aircraft Owners and Pilots Assn		CHART - BOTTOM CARD		CHART	Jeppesen ChartView	CYCLE	1103	EXPIRES	17-FEB-11	DISABLES	28-APR-11	Copyright 2011. Jeppesen Sanderson, Inc.		<table border="1"> <thead> <tr><th colspan="2">MFD1 DATABASE</th></tr> </thead> <tbody> <tr><td colspan="2">APT DIRECTORY - BOTTOM CARD</td></tr> <tr><td>REGION</td><td>US</td></tr> <tr><td>VERSION</td><td>1.01</td></tr> <tr><td>CYCLE</td><td>11D1</td></tr> <tr><td>EFFECTIVE</td><td>13-JAN-11</td></tr> <tr><td>EXPIRES</td><td>10-MAR-11</td></tr> <tr><td colspan="2">Copyright 2010 Aircraft Owners and Pilots Assn</td></tr> <tr><td colspan="2">CHART - BOTTOM CARD</td></tr> <tr><td>CHART</td><td>Jeppesen ChartView</td></tr> <tr><td>CYCLE</td><td>1103</td></tr> <tr><td>EXPIRES</td><td>17-FEB-11</td></tr> <tr><td>DISABLES</td><td>28-APR-11</td></tr> <tr><td colspan="2">Copyright 2011. Jeppesen Sanderson, Inc.</td></tr> </tbody> </table>	MFD1 DATABASE		APT DIRECTORY - BOTTOM CARD		REGION	US	VERSION	1.01	CYCLE	11D1	EFFECTIVE	13-JAN-11	EXPIRES	10-MAR-11	Copyright 2010 Aircraft Owners and Pilots Assn		CHART - BOTTOM CARD		CHART	Jeppesen ChartView	CYCLE	1103	EXPIRES	17-FEB-11	DISABLES	28-APR-11	Copyright 2011. Jeppesen Sanderson, Inc.		<table border="1"> <thead> <tr><th colspan="2">MFD1 DATABASE</th></tr> </thead> <tbody> <tr><td>REGION</td><td>US</td></tr> <tr><td>VERSION</td><td>1.01</td></tr> <tr><td>CYCLE</td><td>11D1</td></tr> <tr><td>EFFECTIVE</td><td>13-JAN-11</td></tr> <tr><td>EXPIRES</td><td>10-MAR-11</td></tr> <tr><td colspan="2">Copyright 2010 Aircraft Owners and Pilots Assn</td></tr> <tr><td colspan="2">CHART - UNKNOWN</td></tr> <tr><td>CHART</td><td>Jeppesen ChartView</td></tr> <tr><td>REGION</td><td>NOT AVAILABLE</td></tr> <tr><td>CYCLE</td><td>NOT AVAILABLE</td></tr> <tr><td>EFFECTIVE</td><td>-- -- -- --</td></tr> <tr><td>EXPIRES</td><td>-- -- -- --</td></tr> <tr><td>DISABLES</td><td>-- -- -- --</td></tr> </tbody> </table>	MFD1 DATABASE		REGION	US	VERSION	1.01	CYCLE	11D1	EFFECTIVE	13-JAN-11	EXPIRES	10-MAR-11	Copyright 2010 Aircraft Owners and Pilots Assn		CHART - UNKNOWN		CHART	Jeppesen ChartView	REGION	NOT AVAILABLE	CYCLE	NOT AVAILABLE	EFFECTIVE	-- -- -- --	EXPIRES	-- -- -- --	DISABLES	-- -- -- --
MFD1 DATABASE																																																																																						
APT DIRECTORY - BOTTOM CARD																																																																																						
REGION	US																																																																																					
VERSION	1.01																																																																																					
CYCLE	11D1																																																																																					
EFFECTIVE	13-JAN-11																																																																																					
EXPIRES	10-MAR-11																																																																																					
Copyright 2010 Aircraft Owners and Pilots Assn																																																																																						
CHART - BOTTOM CARD																																																																																						
CHART	Jeppesen ChartView																																																																																					
CYCLE	1103																																																																																					
EXPIRES	17-FEB-11																																																																																					
DISABLES	28-APR-11																																																																																					
Copyright 2011. Jeppesen Sanderson, Inc.																																																																																						
MFD1 DATABASE																																																																																						
APT DIRECTORY - BOTTOM CARD																																																																																						
REGION	US																																																																																					
VERSION	1.01																																																																																					
CYCLE	11D1																																																																																					
EFFECTIVE	13-JAN-11																																																																																					
EXPIRES	10-MAR-11																																																																																					
Copyright 2010 Aircraft Owners and Pilots Assn																																																																																						
CHART - BOTTOM CARD																																																																																						
CHART	Jeppesen ChartView																																																																																					
CYCLE	1103																																																																																					
EXPIRES	17-FEB-11																																																																																					
DISABLES	28-APR-11																																																																																					
Copyright 2011. Jeppesen Sanderson, Inc.																																																																																						
MFD1 DATABASE																																																																																						
REGION	US																																																																																					
VERSION	1.01																																																																																					
CYCLE	11D1																																																																																					
EFFECTIVE	13-JAN-11																																																																																					
EXPIRES	10-MAR-11																																																																																					
Copyright 2010 Aircraft Owners and Pilots Assn																																																																																						
CHART - UNKNOWN																																																																																						
CHART	Jeppesen ChartView																																																																																					
REGION	NOT AVAILABLE																																																																																					
CYCLE	NOT AVAILABLE																																																																																					
EFFECTIVE	-- -- -- --																																																																																					
EXPIRES	-- -- -- --																																																																																					
DISABLES	-- -- -- --																																																																																					

ChartView has Expired, but is not Disabled

ChartView Database is Disabled

ChartView Database is Not Available

Figure 8-47 AUX – System Status Page, ChartView Database Status

8.4 FLITECHARTS

FliteCharts resemble the paper version of AeroNav Services terminal procedures charts. The charts are displayed with high-resolution and in color for applicable charts. FliteCharts database subscription is available from Garmin. Available data includes:

- Arrivals (STAR)
- Departure Procedures (DP)
- Approaches
- Airport Diagrams

FLITECHARTS SOFTKEYS

FliteCharts functions are displayed on three levels of softkeys. While on the Navigation Map Page, Nearest Airports Page, or Flight Plan Page, pressing the **SHW CHRT** Softkey displays the available terminal chart and advances to the chart selection level of softkeys: **CHRT OPT**, **CHRT**, **INFO-1**, **DP**, **STAR**, **APR**, **WX**, and **GO BACK**. The chart selection softkeys appear on the Airport Information Page.

Pressing the **GO BACK** Softkey reverts to the top level softkeys and previous page.

Pressing the **CHRT OPT** Softkey displays the available terminal chart and advances to the next level of softkeys: **ALL**, **FIT WDTN**, **FULL SCN**, and **BACK**.

While viewing the **CHRT OPT** Softkeys, after 45 seconds of softkey inactivity, the system reverts to the chart selection softkeys.

NOTAMs are not available with FliteCharts. The NOTAM Softkey label appears subdued and is disabled.

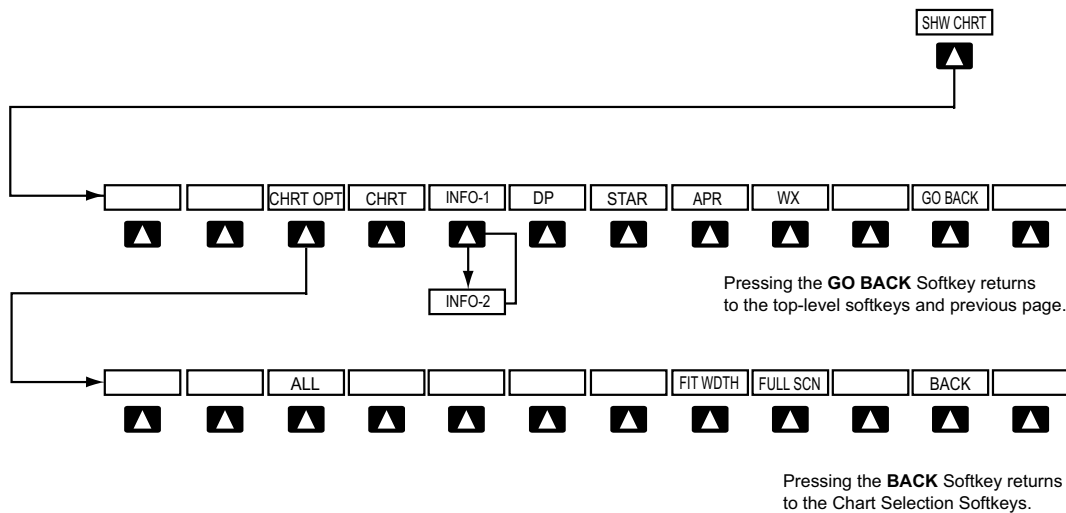

Figure 8-48 FliteCharts SHW CHRT, Chart Selection, and Chart Option Softkeys

TERMINAL PROCEDURES CHARTS

Selecting Terminal Procedures Charts:

While viewing the Navigation Map Page, Nearest Airport Page, or Flight Plan Page, press the **SHW CHRT** Softkey.

Or:

- 1) Press the **MENU** Key to display the PAGE MENU.
- 2) Turn the large **FMS** Knob to scroll through the OPTIONS Menu to Show Chart.
- 3) Press the **ENT** Key to display the chart.

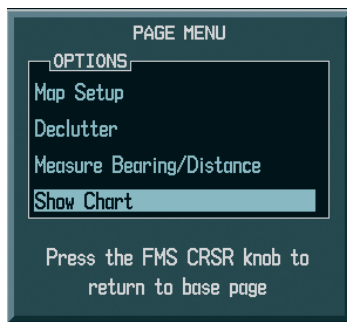

Navigation Map Page OPTIONS Menu



Waypoint Airport Information Page OPTIONS Menu

Figure 8-49 Option Menus

When no terminal procedure chart is available, the banner **CHART NOT AVAILABLE** appears on the screen. The **CHART NOT AVAILABLE** banner does not refer to the FliteCharts subscription, but rather the availability of a particular airport chart selection or procedure for a selected airport.



Figure 8-50 Chart Not Available Banner

If there is a problem in rendering the data (such as a data error or a failure of an individual chart), the banner **UNABLE TO DISPLAY CHART** is then displayed.



Figure 8-51 Unable To Display Chart Banner

When a chart is not available by pressing the **SHW CHRT** Softkey or selecting a Page Menu Option, charts may be obtained for other airports from the WPT Pages or Flight Plan Pages.

If a chart is available for the destination airport, or the airport selected in the active flight plan, the chart appears on the screen. When no flight plan is active, or when not flying to a direct-to destination, pressing the **SHW CHRT** Softkey displays the chart for the nearest airport, if available.

The chart shown is one associated with the WPT – Airport Information page. Usually this is the airport runway diagram. Where no runway diagram exists, but Take Off Minimums or Alternate Minimums are available, that page appears. If Airport Information pages are unavailable, the Approach Chart for the airport is shown.

Selecting a chart:

- 1) While viewing the Navigation Map Page, Flight Plan Page, or Nearest Airports Page, press the **SHW CHRT** Softkey. The airport diagram or approach chart is displayed on the Airport Information Page.
- 2) Press the **FMS** Knob to activate the cursor.
- 3) Turn the large **FMS** Knob to select either the Airport Identifier Box or the Approach Box. (Press the **APR** Softkey if the Approach Box is not currently shown).
- 4) Turn the small and large **FMS** Knob to enter the desired airport identifier.
- 5) Press the **ENT** Key to complete the airport selection.
- 6) Turn the large **FMS** Knob to select the Approach Box.
- 7) Turn the small **FMS** Knob to show the approach chart selection choices.
- 8) Turn either **FMS** Knob to scroll through the available charts.
- 9) Press the **ENT** Key to complete the chart selection.

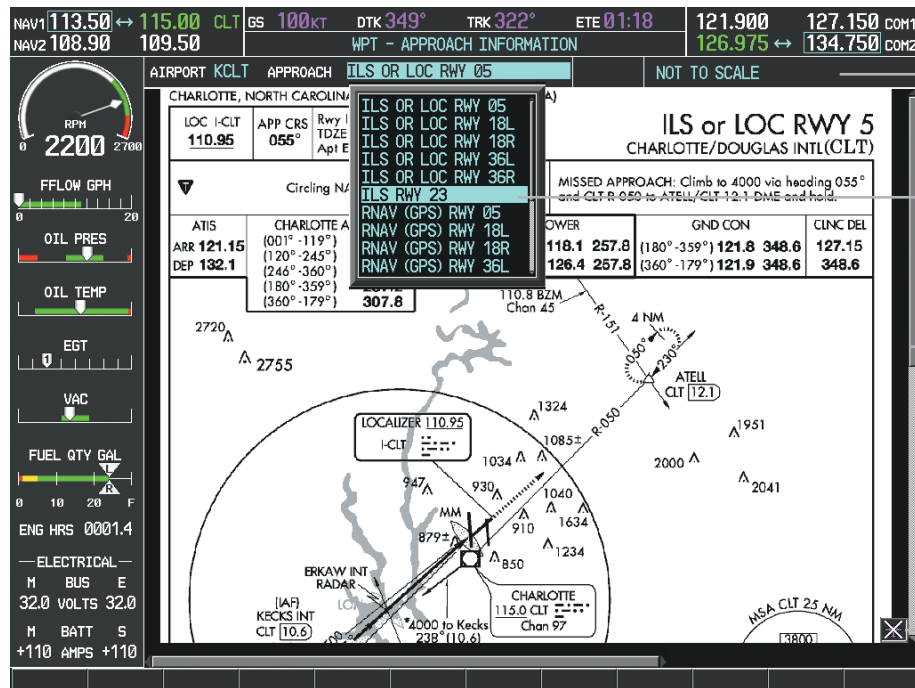

Chart Not To Scale

Select Desired Approach Chart from Menu

Pan Chart With the Joystick

Aircraft Not Shown Icon

Figure 8-52 Approach Information Page, Chart Selection

SYSTEM OVERVIEW

FLIGHT INSTRUMENTS

EIS

AUDIO PANEL & CNS

FLIGHT MANAGEMENT

HAZARD AVOIDANCE

AFCS

ADDITIONAL FEATURES

APPENDICES

INDEX

While the APPROACH Box is selected using the **FMS** Knob, the G1000 softkeys are blank. Once the desired chart is selected, the chart scale can be changed and the chart can be panned using the **Joystick**. Pressing the **Joystick** centers the chart on the screen.

The aircraft symbol is not shown on FliteCharts. The Chart Scale Box displays a banner NOT TO SCALE, and the Aircraft Not Shown Icon is displayed in the lower right corner of the screen.

Pressing the **CHRT** Softkey alternates between the FliteCharts diagram and the associated map in the WPT page group. In the example shown, the **CHRT** Softkey switches between the Charlotte, NC (KCLT) Airport Diagram and the navigation map on the WPT – Airport Information page.



Press **CHRT** Softkey to Switch Between FliteCharts and Navigation Map Page

Figure 8-53 CHRT Softkey, Airport Information Page

Pressing the **INFO-1** or **INFO-2** Softkey returns to the airport diagram when the view is on a different chart. If the displayed chart is the airport diagram, the **INFO-1** or **INFO-2** Softkey has no effect.

Another source for additional airport information is from the INFO Box above the chart (Figure 8-52) or to the right of the chart (Figure 8-54) for certain airports. This information source is not related to the **INFO-1** or **INFO-2** Softkey. When the INFO Box is selected using the **FMS** Knob, the G1000 softkeys are blank. The Charlotte, NC airport has three additional charts offering information; the Airport Diagram, Alternate Minimums, and Take-off Minimums.

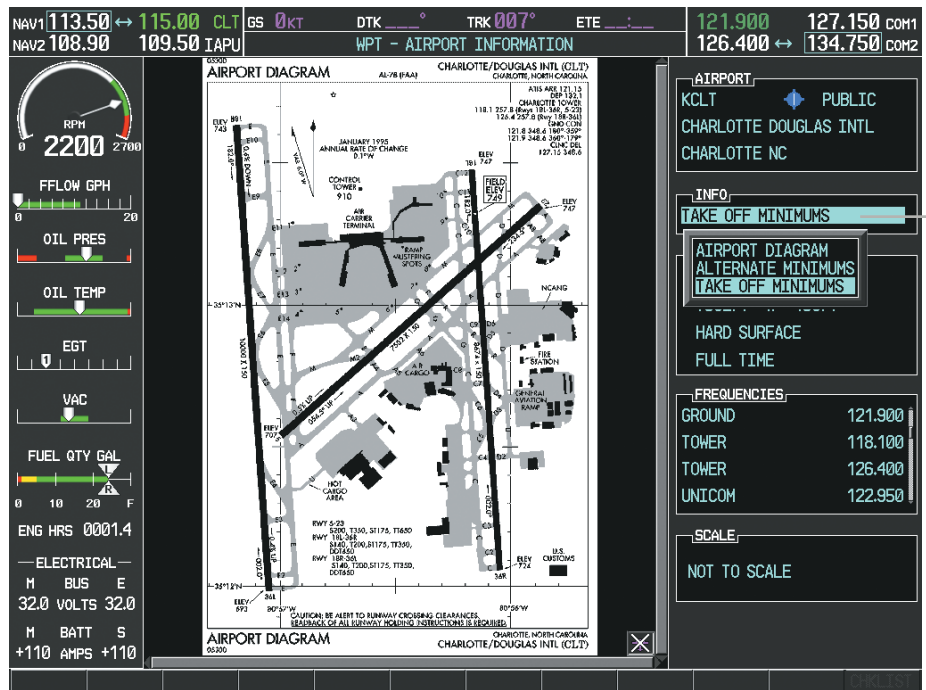

Info Box Selected

Figure 8-54 Airport Information Page, INFO View with Airport Information

In the example shown in Figure 8-54, TAKE OFF MINIMUMS is selected. Pressing the ENT Key displays the Take-off Minimums and Departure Procedures Chart (Figure 8-55).

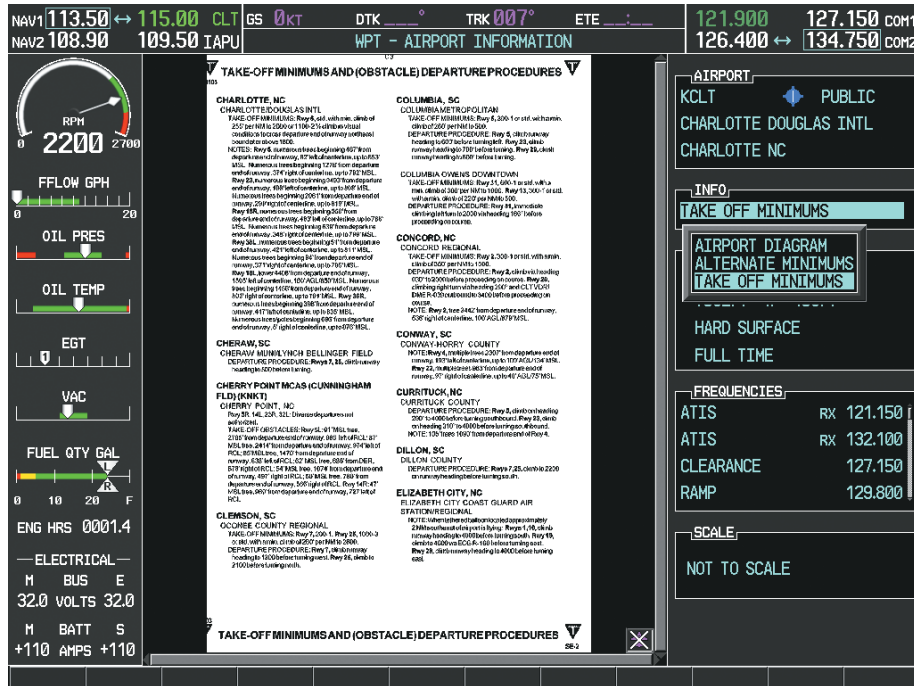

Figure 8-55 Airport Information Page, TAKE OFF MINIMUMS Selected from INFO View

Pressing the DP Softkey displays the Departure Procedure Chart if available.

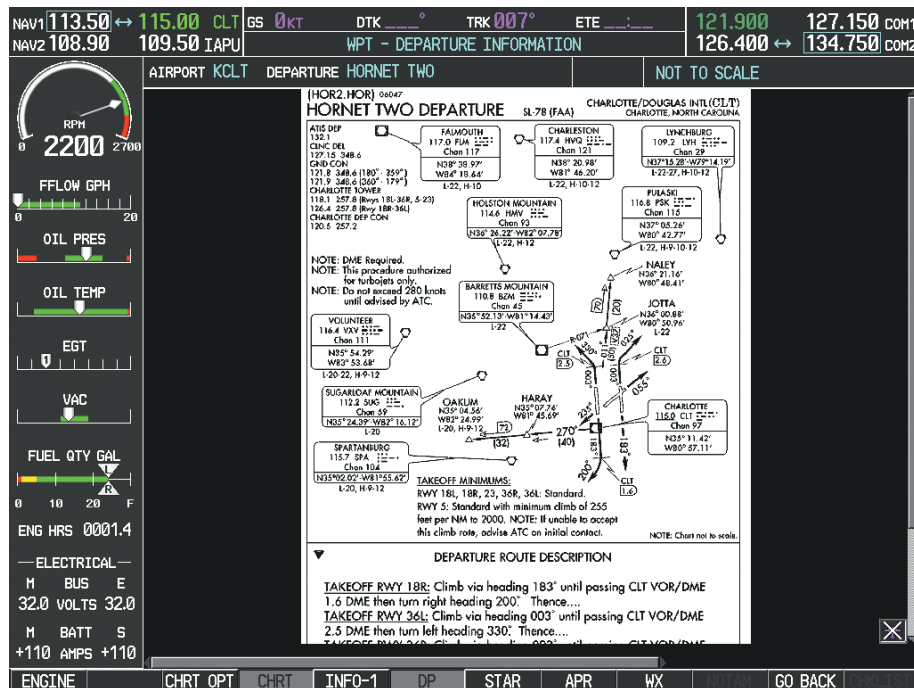

Figure 8-56 Departure Procedure Page

Pressing the **STAR** Softkey displays the Standard Terminal Arrival Chart if available.

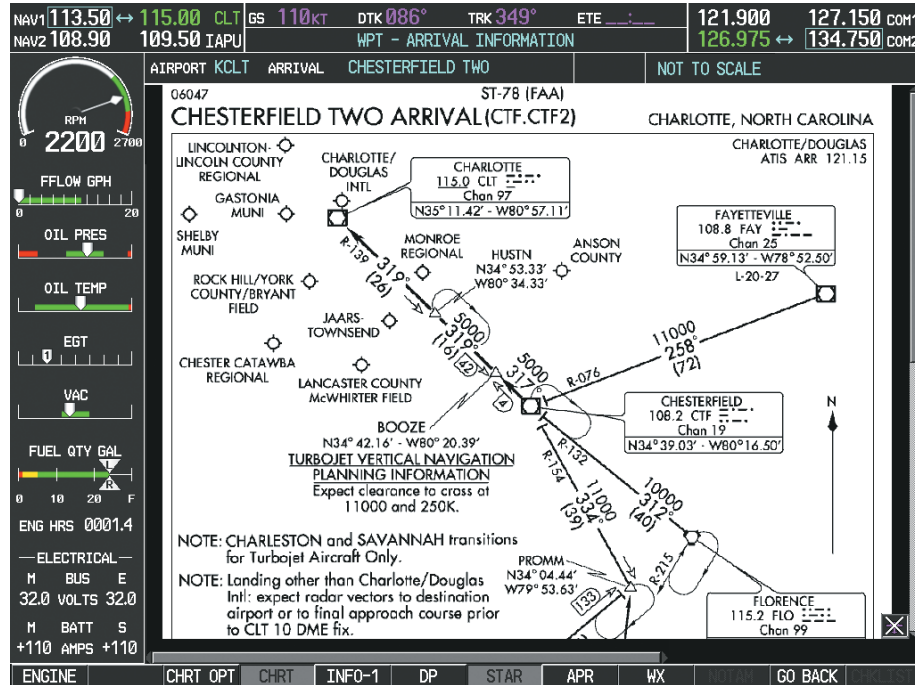

Figure 8-57 Arrival Information Page

Pressing the **APR** Softkey displays the approach chart for the airport if available.

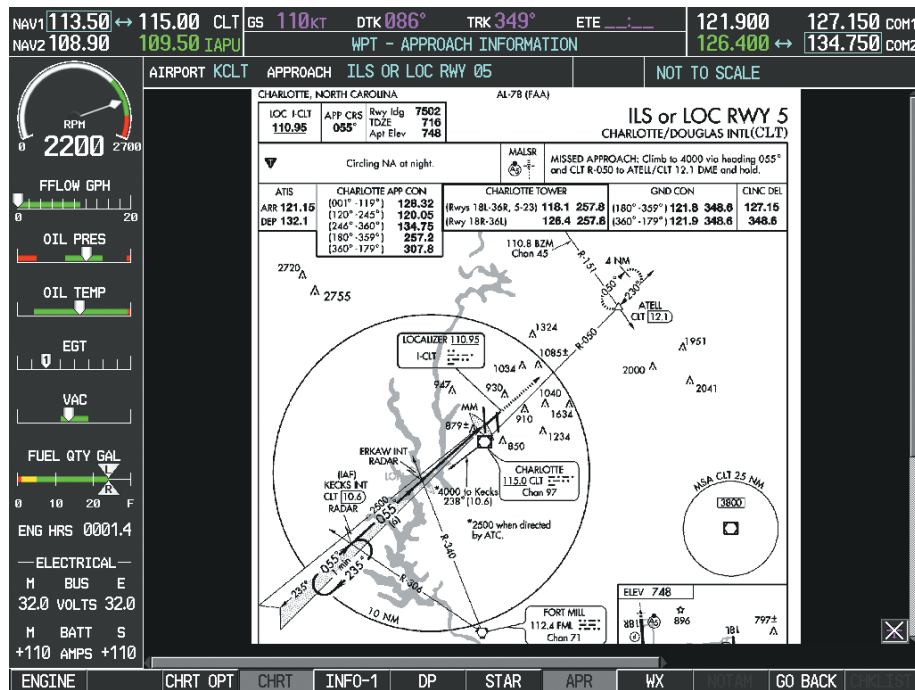

Figure 8-58 Approach Information Page

Pressing the **WX** Softkey shows the airport weather frequency information, when available, and includes weather data such as METAR and TAF from the XM Data Link Receiver. Weather information is available only when an XM Data Link Receiver is installed and the XM WX Satellite Weather subscription is current.

Selecting Additional Information:

- 1) While viewing the Airport Taxi Diagram, press the **WX** Softkey to display the information windows (AIRPORT, INFO).
- 2) Press the **FMS** Knob to activate the cursor.
- 3) Turn the large **FMS** Knob to highlight the INFO Box.
- 4) Turn the small **FMS** Knob to select the INFO Box choices. When the INFO Box is selected the G1000 softkeys are blank. If multiple choices are available, scroll to the desired choice with the large **FMS** Knob and press the **ENT** Key to complete the selection.
- 5) Press the **FMS** Knob again to deactivate the cursor.

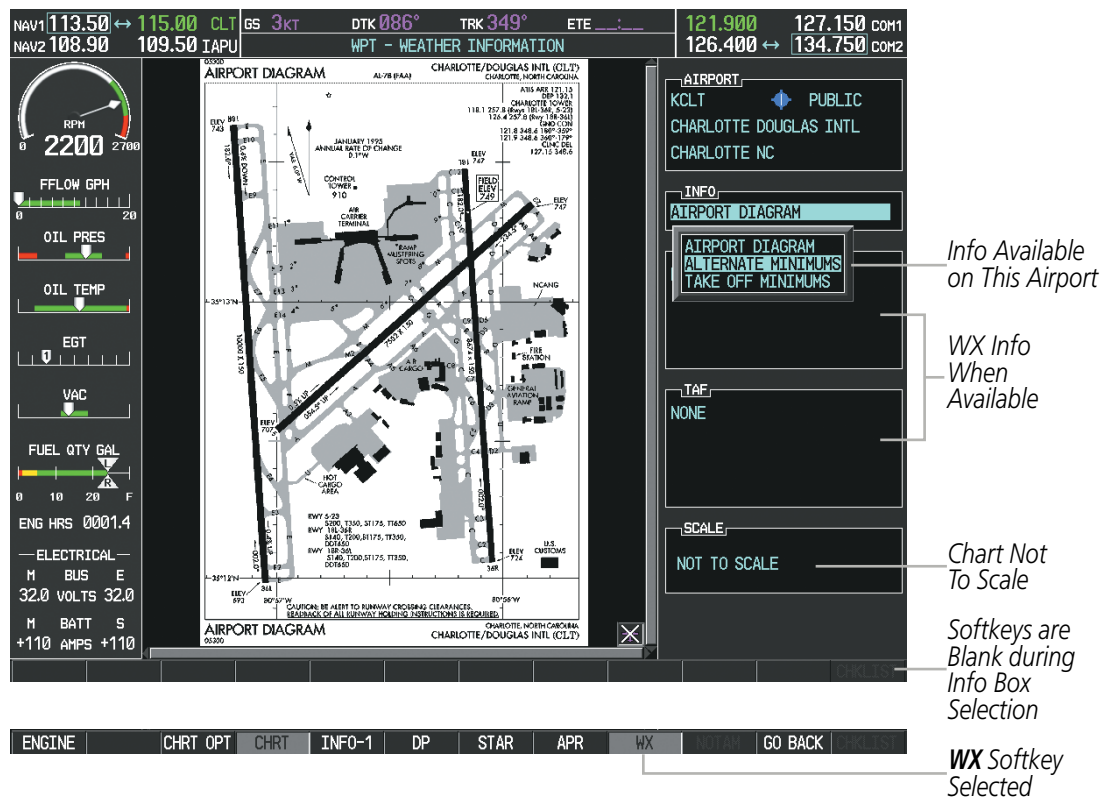

Figure 8-59 Weather Information Page, WX Softkey Selected

Pressing the **GO BACK** Softkey reverts to the previous page (Navigation Map Page or Flight Plan Page).

CHART OPTIONS

Pressing the **CHRT OPT** Softkey displays the next level of softkeys, the chart options level (Figure 8-48). Pressing the **ALL** Softkey shows the complete chart on the screen.



Complete Chart Shown

Figure 8-60 Airport Information Page, ALL View Selected

- SYSTEM OVERVIEW
- FLIGHT INSTRUMENTS
- EIS
- AUDIO PANEL & CNS
- FLIGHT MANAGEMENT
- HAZARD AVOIDANCE
- AFCS
- ADDITIONAL FEATURES
- APPENDICES
- INDEX

Pressing the **FIT WIDTH** Softkey fits the width of the chart in the display viewing area. In the example shown, the chart at close range is replaced with the full width chart.

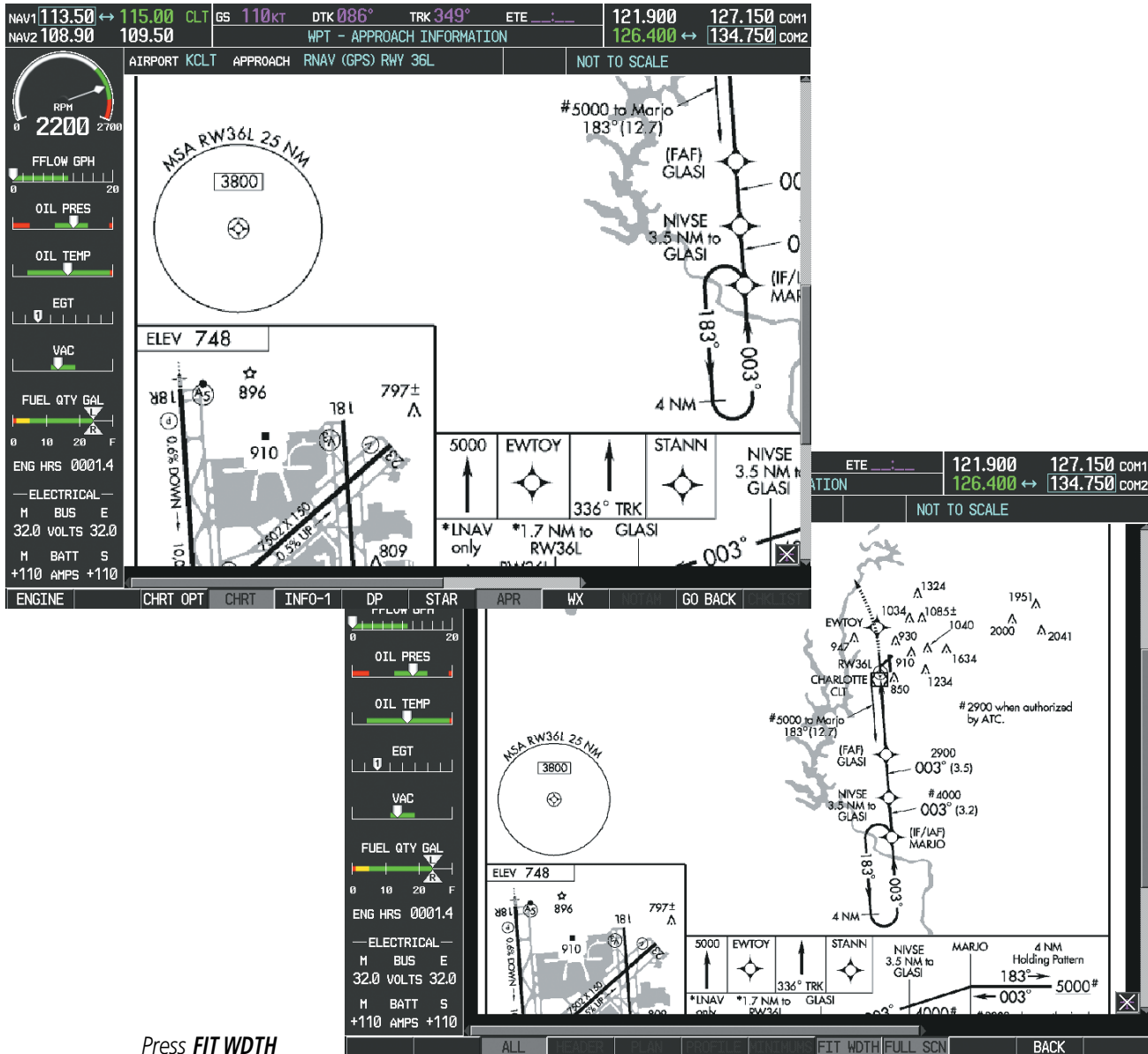

Press **FIT WIDTH** Softkey to Show Full Chart Width

Figure 8-61 Approach Information Page, FIT WIDTH Softkey Selected

Pressing the **FULL SCN** Softkey alternates between removing and replacing the data window to the right.

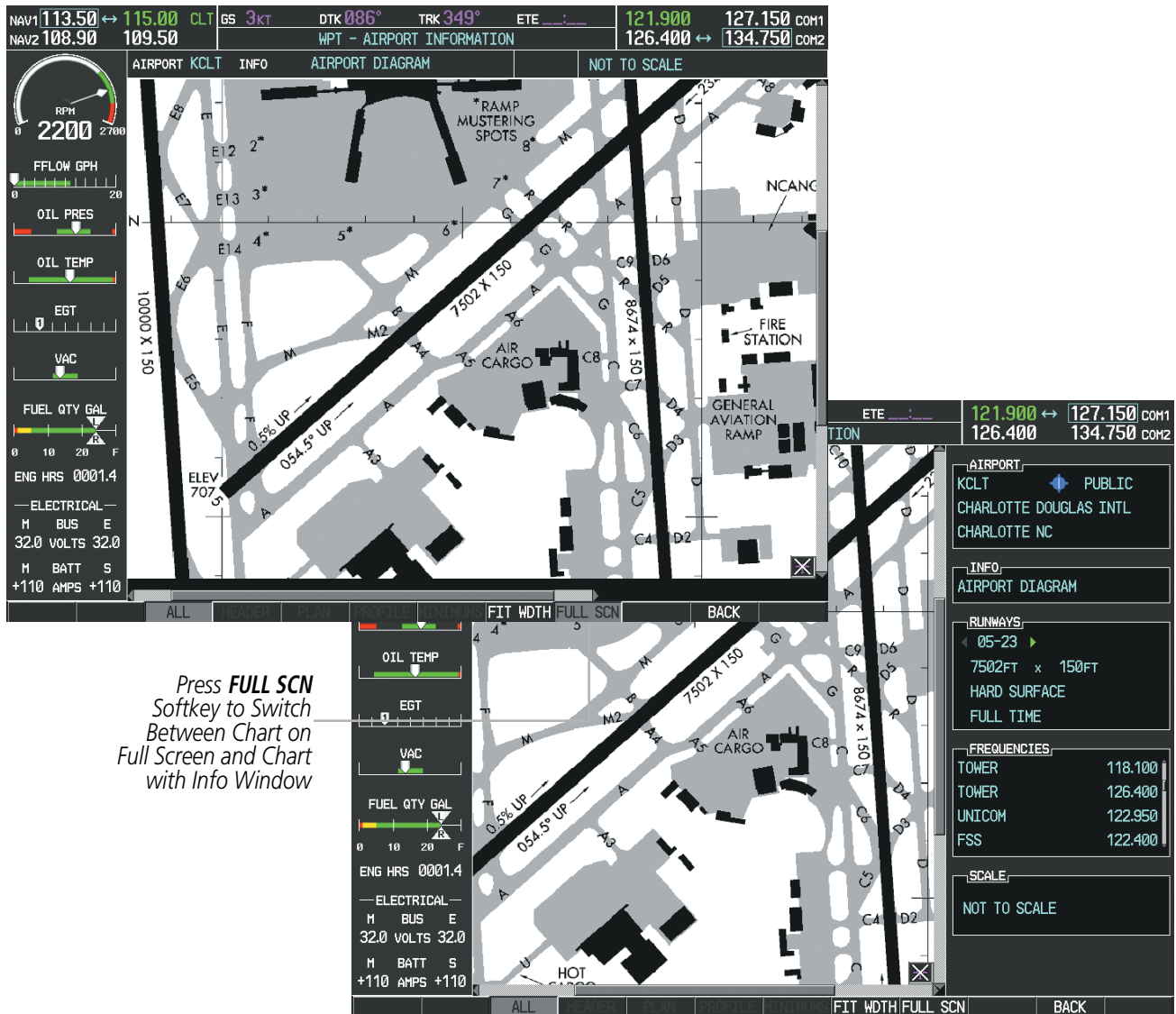

Figure 8-62 Airport Information Page, Full Screen and Info Window

Pressing the **BACK** Softkey, or waiting for 45 seconds reverts to the chart selection softkeys.

SYSTEM OVERVIEW

FLIGHT INSTRUMENTS

EIS

AUDIO PANEL & CNS

FLIGHT MANAGEMENT

HAZARD AVOIDANCE

AFCS

ADDITIONAL FEATURES

APPENDICES

INDEX

The full screen view can also be selected by using the page menu option.

Selecting full screen On or Off:

- 1) While viewing a terminal chart press the **MENU** Key to display the Page Menu OPTIONS.
- 2) Turn the large **FMS** Knob to highlight the Chart Setup Menu Option and press the **ENT** Key.
- 3) Turn the large **FMS** Knob to move between the FULL SCREEN and COLOR SCHEME Options.
- 4) Turn the small **FMS** Knob to choose between the On and Off Full Screen Options.

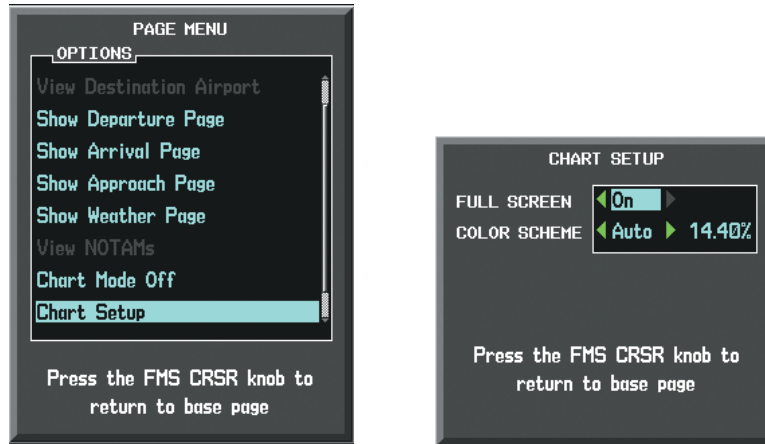

Chart Setup Option

Full Screen On/Off Selection

Figure 8-63 Page Menus

DAY/NIGHT VIEW

FliteCharts can be displayed on a white or black background for day or night viewing. The Day View offers a better presentation in a bright environment. The Night View gives a better presentation for viewing in a dark environment. When the CHART SETUP Box is selected the G1000 softkeys are blank.

Selecting Day, Night, or Automatic View:

- 1) While viewing a terminal chart press the **MENU** Key to display the Page Menu OPTIONS.
- 2) Turn the large **FMS** Knob to highlight the Chart Setup Menu Option and press the **ENT** Key.

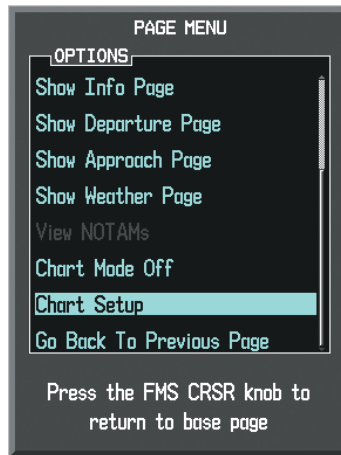

Figure 8-64 Waypoint Information Page, OPTIONS Menu

- 3) Turn the large **FMS** Knob to move to the COLOR SCHEME Option (Figure 8-65).
- 4) Turn the small **FMS** Knob to choose between Day, Auto, and Night Options.
- 5) If Auto Mode is selected, turn the large **FMS** Knob to select the percentage field. Use the small **FMS** Knob to change the percentage value. The percentage value is the day/night crossover point based on the percentage of backlighting intensity. For example, if the value is set to 15%, the day/night display changes when the display backlight reaches 15% of full brightness.

The display must be changed in order for the new setting to become active. This may be accomplished by selecting another page or changing the display range.

- 6) Press the **FMS** Knob when finished to remove the Chart Setup Menu.

- SYSTEM OVERVIEW
- FLIGHT INSTRUMENTS
- EIS
- AUDIO PANEL & CNS
- FLIGHT MANAGEMENT
- HAZARD AVOIDANCE
- AFCS
- ADDITIONAL FEATURES
- APPENDICES
- INDEX

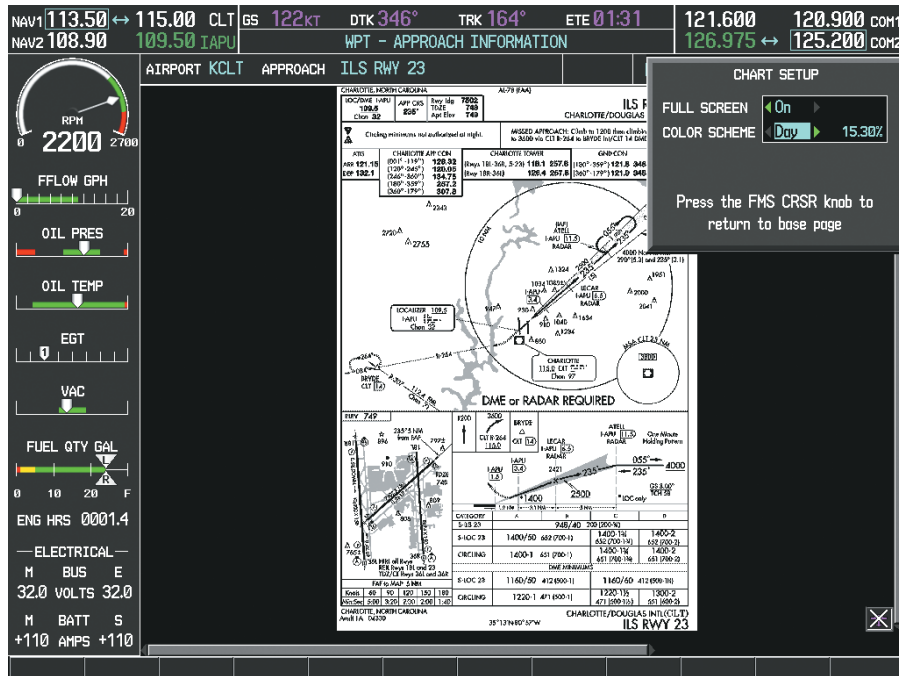

Figure 8-65 Approach Information Page, Day View

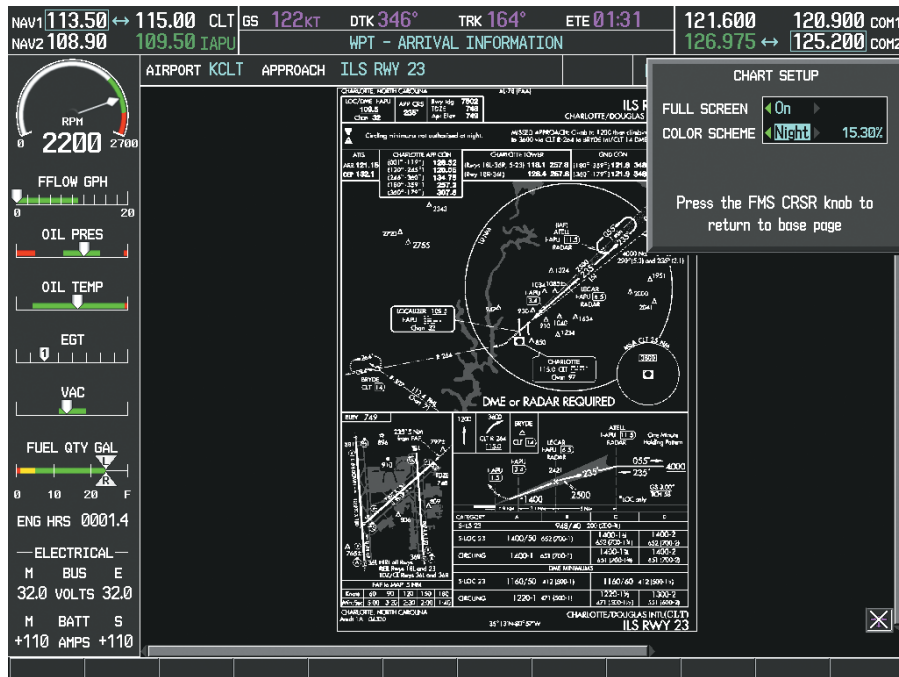

Figure 8-66 Approach Information Page, Night View

FLITECHARTS CYCLE NUMBER AND EXPIRATION DATE

FliteCharts data is revised every 28 days. Charts are still viewable during a period that extends from the cycle expiration date to the disables date. FliteCharts is disabled 180 days after the expiration date and are no longer available for viewing upon reaching the disables date. When turning on the system, the Power-up Page displays the current status of the FliteCharts database. See the table below for the various FliteCharts Power-up Page displays and the definition of each.

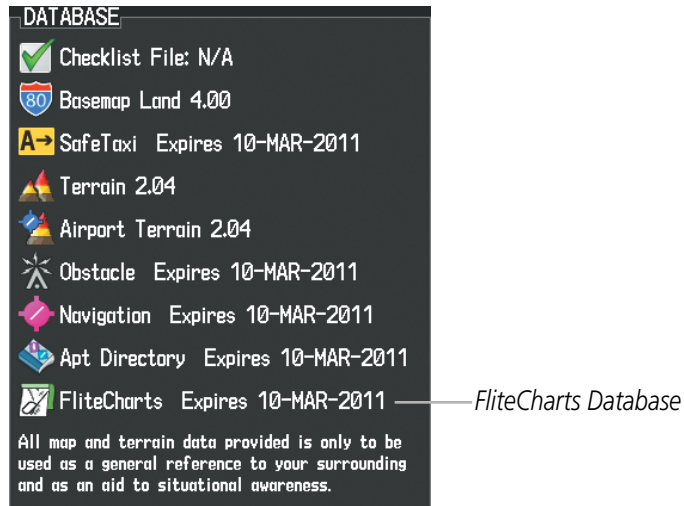

Figure 8-67 Power-up Page, FliteCharts Database

Power-up Page Display	Definition
	Blank Line. system is not configured for FliteCharts. Contact a Garmin-authorized service center for configuration.
Chart Data: N/A	System is configured for FliteCharts but no chart database is installed. Refer to Updating Garmin Databases in Appendix B for the FliteCharts database
FliteCharts Expires 10-MAR-2011	Normal operation. FliteCharts database is valid and within current cycle.
Chart data is out of date!	FliteCharts database is beyond the expiration date, but still within the 180 day viewing period.
Chart data is disabled.	FliteCharts database has timed out. Database is beyond 180 days after expiration date. FliteCharts database is no longer available for viewing.

Table 8-3 FliteCharts Power-up Page Annunciations and Definitions

Other possible AUX - System Status page conditions are shown in Figure 8-68. ‘FliteCharts Expires’ plus a date in white, indicates the chart database is current. ‘Chart data is out of date!’ in yellow, indicates charts are still viewable, but approaching the disable date.

SYSTEM OVERVIEW

FLIGHT INSTRUMENTS

EIS

AUDIO PANEL & CNS

FLIGHT MANAGEMENT

HAZARD AVOIDANCE

AFCS

ADDITIONAL FEATURES

APPENDICES

INDEX

When the 180 day grace period has expired, 'Chart data is disabled.' in yellow indicates that the FliteCharts database has expired and is no longer viewable. 'Chart Data: N/A' appears in white if no FliteCharts data is available on the database card or no database card is inserted.

FliteCharts time critical information can also be found on the AUX - System Status page. The FliteCharts database REGION, CYCLE number, EFFECTIVE, EXPIRES, and DISABLES dates of the subscription appear in either blue or yellow text. Dates shown in blue are current data. Dates shown in yellow indicate the data is not within the current subscription period.

FliteCharts becomes inoperative 180 days after the FliteCharts EXPIRES date is reached, and is no longer available for viewing. This date is shown as the DISABLES date. After the disable date the **SHW CHRT** Softkey label appears subdued and is unavailable until a revised issue of FliteCharts is installed.

NOTE: A subdued softkey label indicates the function is disabled.

Press the **MFD1 DB** Softkey to place the cursor in the DATABASE window. Scroll through the listed information by turning the **FMS** Knob or pressing the **ENT** Key until the FliteCharts database information is shown.

The FliteCharts database cycle number shown in the figure, 1102, is deciphered as follows:

11 – Indicates the year 2011

02 – Indicates the second issue of the FliteCharts database for the year

The FliteCharts EFFECTIVE date 10-FEB-11 is the first date that this database is current.

The FliteCharts EXPIRES date 10-MAR-11 is the last date that this database is current.

The DISABLES date 06-SEP-11 is the date that this database becomes inoperative.

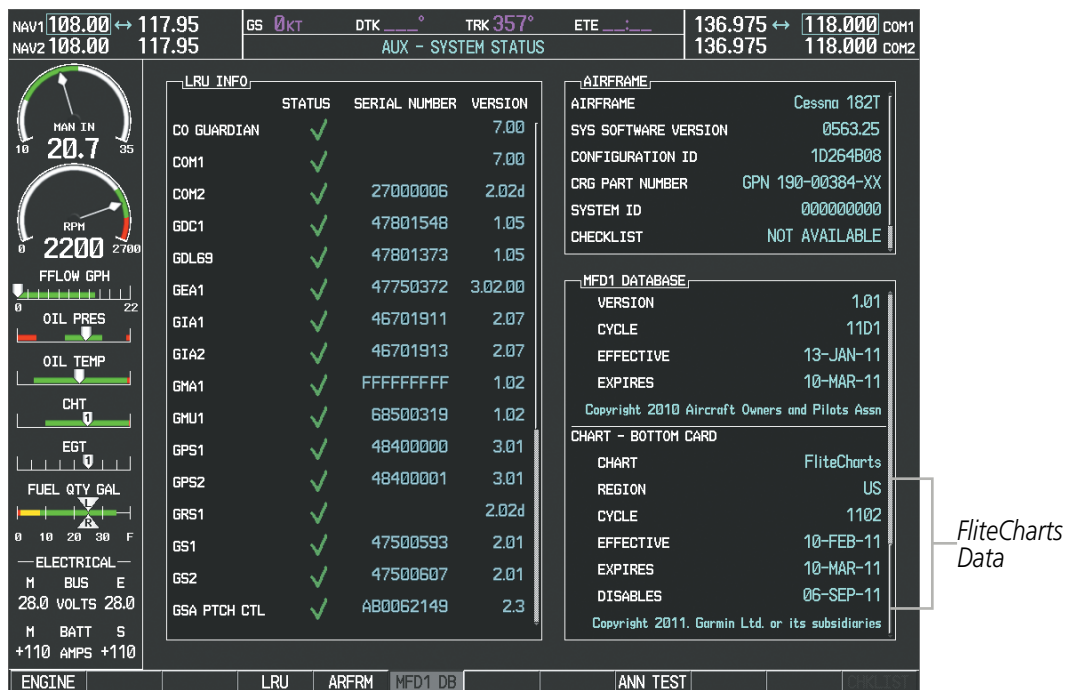

Figure 8-68 AUX – System Status Page, FliteCharts Current and Available

The FliteCharts database is provided from Garmin. Refer to Updating Garmin Databases in Appendix B for instructions on revising the FliteCharts database.

The other four possible AUX - System Status page conditions are shown here. The EFFECTIVE date, in yellow, indicates the current date precedes the date the FliteCharts database becomes effective. The EXPIRES date, in yellow, is the revision date for the next database cycle. The DISABLES date, in yellow, is the date that this database cycle is no longer viewable. NOT AVAILABLE in blue, indicate the FliteCharts database is not available on the database card or no database card is inserted.

<p>MFD1 DATABASE</p> <p>VERSION 1.01</p> <p>CYCLE 11D1</p> <p>EFFECTIVE 13-JAN-11</p> <p>EXPIRES 10-MAR-11</p> <p>Copyright 2010 Aircraft Owners and Pilots Assn</p> <p>CHART - BOTTOM CARD</p> <p>CHART FliteCharts</p> <p>REGION US</p> <p>CYCLE 1102</p> <p>EFFECTIVE 10-FEB-11</p> <p>EXPIRES 10-MAR-11</p> <p>DISABLES 06-SEP-11</p> <p>Copyright 2011. Garmin Ltd. or its subsidiaries</p>	<p>MFD1 DATABASE</p> <p>VERSION 1.01</p> <p>CYCLE 11D1</p> <p>EFFECTIVE 13-JAN-11</p> <p>EXPIRES 10-MAR-11</p> <p>Copyright 2010 Aircraft Owners and Pilots Assn</p> <p>CHART - BOTTOM CARD</p> <p>CHART FliteCharts</p> <p>REGION US</p> <p>CYCLE 1102</p> <p>EFFECTIVE 10-FEB-11</p> <p>EXPIRES 10-MAR-11</p> <p>DISABLES 06-SEP-11</p> <p>Copyright 2011. Garmin Ltd. or its subsidiaries</p>	<p>MFD1 DATABASE</p> <p>VERSION 1.01</p> <p>CYCLE 11D1</p> <p>EFFECTIVE 13-JAN-11</p> <p>EXPIRES 10-MAR-11</p> <p>Copyright 2010 Aircraft Owners and Pilots Assn</p> <p>CHART - BOTTOM CARD</p> <p>CHART FliteCharts</p> <p>REGION US</p> <p>CYCLE 1102</p> <p>EFFECTIVE 10-FEB-11</p> <p>EXPIRES 10-MAR-11</p> <p>DISABLES 06-SEP-11</p> <p>Copyright 2011. Garmin Ltd. or its subsidiaries</p>
--	--	--

Current Date is Before Effective Date

FliteCharts Expired, but is not Disabled

FliteCharts Database is Disabled

<p>MFD1 DATABASE</p> <p>VERSION 1.01</p> <p>CYCLE 11D1</p> <p>EFFECTIVE 13-JAN-11</p> <p>EXPIRES 10-MAR-11</p> <p>Copyright 2010 Aircraft Owners and Pilots Assn</p> <p>CHART - UNKNOWN</p> <p>CHART FliteCharts</p> <p>REGION NOT AVAILABLE</p> <p>CYCLE NOT AVAILABLE</p> <p>EFFECTIVE -- -- -- --</p> <p>EXPIRES -- -- -- --</p> <p>DISABLES -- -- -- --</p>

FliteCharts Database is Not Available

Figure 8-69 AUX – System Status Page, FliteCharts Database Status

8.5 AOPA AIRPORT DIRECTORY

The Aircraft Owners and Pilots Association (AOPA) Airport Directory database offers detailed information regarding services, hours of operation, lodging options, and more. This information is viewed on the Airport Directory Page as shown in Figure 8-70.

Selecting the Airport Directory Page:

- 1) Turn the large **FMS** Knob to select the 'WPT' page group.
- 2) Turn the small **FMS** Knob to select the AIRPORT INFORMATION Page. Initially, information for the airport closest to the aircraft's present position is displayed.
- 3) If necessary, press the INFO softkey until **INFO-2** is displayed.



Figure 8-70 AOPA Information on the Airport Information Page

AOPA DATABASE CYCLE NUMBER AND REVISION

The AOPA Airport Directory database is revised four times per year. Check fly.garmin.com for the current database. The Airport Directory is always available for use after the expiration date. When turning on the system, the Power-up Page indicates whether the databases are current, out of date, or not available.

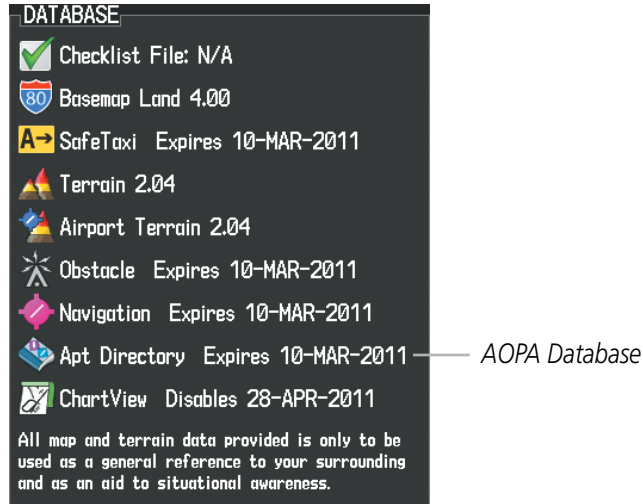

Figure 8-71 Power-up Page, Airport Directory Database

Power-up Page Display	Definition
Apt Directory Expires 10-MAR-2011	Normal operation. AOPA Airport Directory database is valid and within current cycle.
Apt Directory Expires 10-MAR-2011	AOPA Airport Directory database has expired.
Apt Directory N/A	Database card contains no AOPA Airport Directory data.

Table 8-4 Airport Directory Annunciation Definitions

The Airport Directory Region, Version, Cycle, Effective date and Expires date of the database cycle can also be found on the AUX - System Status page, as seen in Figure 8-72.

Press the **MFD1 DB** Softkey to place the cursor in the DATABASE window. Scroll through the listed information by turning the **FMS** Knob or pressing the **ENT** Key until the Airport Directory database information is shown.

SYSTEM OVERVIEW

FLIGHT INSTRUMENTS

EIS

AUDIO PANEL & CNS

FLIGHT MANAGEMENT

HAZARD AVOIDANCE

AFCS

ADDITIONAL FEATURES

APPENDICES

INDEX

The Airport Directory database cycle number shown in the figure, 11D1, is deciphered as follows:

11 – Indicates the year 2011

D – Indicates the data is for Airport Directory

1 – Indicates the first issue of the Airport Directory database for the year

The Airport Directory EFFECTIVE date 13-JAN-11 is the beginning date for the current database cycle. The Airport Directory EXPIRES date 10-MAR-11 is the revision date for the next database cycle.



Airport Directory Data

Figure 8-72 AUX – System Status Page, Airport Directory Current Information

Airport Directory information appears in blue and yellow text. The EFFECTIVE date appears in blue when data is current and in yellow when the current date is before the effective date. The EXPIRES date appears in blue when data is current and in yellow when expired (Table 8-4). NOT AVAILABLE appears in blue in the REGION field if Airport Directory data is not available on the database card. An expired Airport Directory database is not disabled and will continue to function indefinitely.

8.6 SIRIUSXM SATELLITE RADIO (SERVICE OPTIONAL)



NOTE: Refer to the Hazard Avoidance Section for information about XM WX Satellite Weather products.

The optional SiriusXM Satellite Radio entertainment feature of the GDL 69A Data Link Receiver is available for the pilot's and passengers' enjoyment. The GDL 69A can receive SiriusXM Satellite Radio entertainment services at any altitude throughout the Continental U.S. Entertainment audio is not available on the GDL 69 Data Link Receiver.

SiriusXM Satellite Radio offers a variety of radio programming over long distances without having to constantly search for new stations. Based on signals from satellites, coverage far exceeds land-based transmissions. SiriusXM Satellite Radio services are subscription-based. For more information on specific service packages, visit www.siriusxm.com.

ACTIVATING SIRIUSXM SATELLITE RADIO SERVICES

The service is activated by providing SiriusXM Satellite Radio with either one or two coded IDs, depending on the equipment. Either the Audio Radio ID or the Data Radio ID, or both, must be provided to SiriusXM Satellite Radio to activate the entertainment subscription.

It is not required to activate both the entertainment and weather service subscriptions with the GDL 69A. Either or both services can be activated. SiriusXM Satellite Radio uses one or both of the coded IDs to send an activation signal that, when received by the GDL 69A, allows it to play entertainment programming.

These IDs are located:

- On the label on the back of the Data Link Receiver
- On the XM Information Page on the MFD (Figure 8-73)
- On the XM Satellite Radio Activation Instructions included with the unit (available at www.garmin.com, P/N 190-00355-04)

Contact the installer if the Data Radio ID and the Audio Radio ID cannot be located.



NOTE: The **LOCK** Softkey on the XM Information Page (Auxiliary Page Group) is used to save GDL 69A activation data when the SiriusXM services are initially set up. It is not used during normal SiriusXM Satellite Radio operation, but there should be no adverse effects if inadvertently pressed during flight. Refer to the GDL 69/69A SiriusXM Satellite Radio Activation Instructions (190-00355-04, Rev H or later) for further information.

Activating the SiriusXM Satellite Radio services:

- 1) Contact SiriusXM Satellite Radio. Follow the instructions provided by SiriusXM Satellite Radio services.
- 2) Select the Auxiliary Page Group.
- 3) Select the next to last page in the AUX Page Group.
- 4) Press the **INFO** Softkey to display the XM Information Page.
- 5) Verify that the desired services are activated.

- 6) Press the **LOCK** Softkey.
- 7) Turn the large **FMS** Knob to highlight YES.
- 8) To complete activation, press the **ENT** Key.



Figure 8-73 XM Information Page

If XM WX Satellite Weather services have not been activated, all the weather product boxes are blank on the XM Information Page and a yellow Activation Required message is displayed in the center of the Weather Data Link Page (Map Page Group). The Service Class refers to the groupings of weather products available for subscription.

USING SIRIUSXM RADIO

The XM Radio Page provides information and control of the audio entertainment features of the SiriusXM Satellite Radio.

Selecting the XM Radio Page:

- 1) Turn the large **FMS** Knob to select the Auxiliary Page Group.
- 2) Turn the small **FMS** Knob to select the displayed AUX - XM Information Page.
- 3) Press the **RADIO** Softkey to show the XM Radio Page where audio entertainment is controlled.



Figure 8-74 XM Radio Page

ACTIVE CHANNEL AND CHANNEL LIST

The Active Channel Box on the XM Radio Page displays the currently selected channel that the SiriusXM Radio is using.

The Channels List Box of the XM Radio Page shows a list of the available channels for the selected category. Channels can be stepped through one at a time or may be selected directly by channel number.

Selecting a channel from the channel list:

- 1) While on the XM Radio Page, press the **CHNL** Softkey.
- 2) Press the **CH +** Softkey to go up through the list in the Channel Box, or move down the list with the **CH -** Softkey.

Or:

- 1) Press the **FMS** Knob to highlight the channel list and turn the large **FMS** Knob to scroll through the channels.
- 2) Press the **ENT** Key to activate the selected channel.

Selecting a channel directly:

- 1) While on the XM Radio Page, press the **CHNL** Softkey.
- 2) Press the **DIR CH** Softkey. The channel number in the Active Channel Box is highlighted.
- 3) Press the numbered softkeys located on the bottom of the display to directly select the desired channel number.
- 4) Press the **ENT** Key to activate the selected channel.

CATEGORY

The Category Box of the XM Radio Page displays the currently selected category of audio. Categories of channels such as jazz, rock, or news can be selected to list the available channels for a type of music or other contents. One of the optional categories is PRESETS to view channels that have been programmed.

Selecting a category:

- 1) Press the **CATGRY** Softkey on the XM Radio Page.
- 2) Press the **CAT +** and **CAT -** Softkeys to cycle through the categories.

Or:

Turn the small **FMS** Knob to display the Categories list. Highlight the desired category with the small **FMS** Knob and press the **ENT** Key. Selecting All Categories places all channels in the list.



Figure 8-75 Categories List

PRESETS

Up to 15 channels from any category can be assigned a preset number. The preset channels are selected by pressing the **PRESETS** and **MORE** Softkeys. Then the preset channel can be selected directly and added to the channel list for the Presets category.

Setting a preset channel number:

- 1) On the XM Radio Page, while listening to an Active Channel that is wanted for a preset, press the **PRESETS** Softkey to access the first five preset channels (**PS1 - PS5**).
- 2) Press the **MORE** Softkey to access the next five channels (**PS6 – PS10**), and again to access the last five channels (**PS11 – PS15**). Pressing the **MORE** Softkey repeatedly cycles through the preset channels.
- 3) Press any one of the (**PS1 - PS15**) softkeys to assign a number to the active channel.
- 4) Press the **SET** Softkey on the desired channel number to save the channel as a preset.

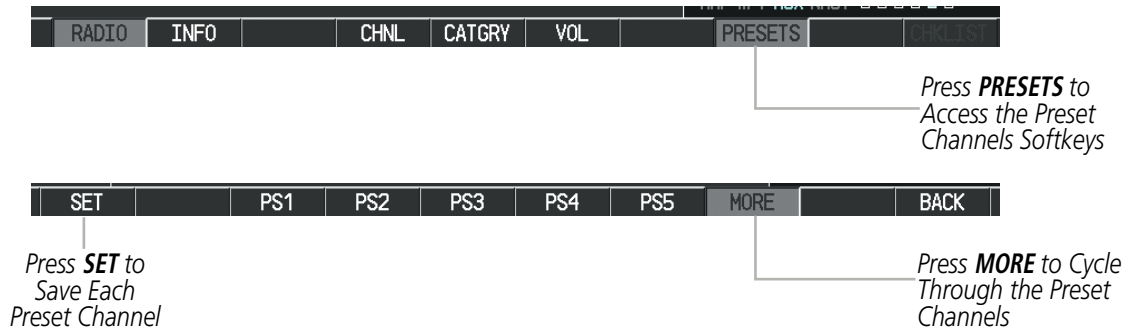

Figure 8-76 Accessing and Selecting XM Preset Channels

Pressing the **BACK** Softkey, or waiting during 45 seconds of softkey inactivity, returns the system to the top level softkeys.

VOLUME

Radio volume is shown as a percentage of full volume. Volume level is controlled by pressing the **VOL** Softkey, which brings up the **MUTE** Softkey and the volume increase and decrease softkeys.

Adjusting the volume:

- 1) With the XM Radio Page displayed, press the **VOL** Softkey.
- 2) Press the **VOL –** Softkey to reduce volume or press the **VOL +** Softkey to increase volume. (Once the **VOL** Softkey is pressed, the volume can also be adjusted using the small **FMS** Knob.)
- 3) Press the **MUTE** Softkey to mute the audio. Press the **MUTE** Softkey again to unmute the audio.

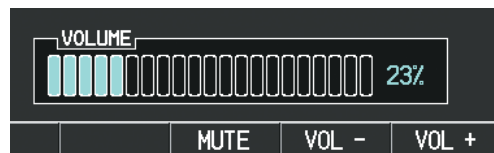

Figure 8-77 Volume Control

AUTOMATIC AUDIO MUTING

SiriusXM Satellite Radio audio is muted automatically when the aircraft groundspeed exceeds approximately 30 knots and the airspeed is less than approximately 80 knots. The audio is not unmuted automatically. The audio must be manually unmuted once the aircraft is airborne and outside the applicable speed range. Automatic Audio Muting has been implemented to meet regulatory requirements that the aural stall warning be heard.

When the aircraft is operating within the automute airspeed range, the **MUTE** Softkey and the volume softkeys are subdued, and the Unmute selection of the Page Menu is unavailable, preventing the audio from being unmuted at this time.

Audio availability conforms to the following three states:

- Audio is available on the ground until the aircraft exceeds 30 knots
- Audio is automatically muted (not available) from Airborne Status up to 80 knots airspeed
- Audio is available when airspeed is over 80 knots

Unmuting SiriusXM audio:

- 1) With the XM Radio Page displayed, press the **VOL** Softkey.
- 2) Press the **MUTE** Softkey to restore (unmute) SiriusXM Audio.



Figure 8-78 Unmuting XM Audio Using Softkeys

Or:

- 1) While on either the XM – Radio Page or the XM – Information Page, press the **MENU** Key to display the PAGE MENU.
- 2) Turn the large **FMS** Knob to select the Unmute option.
- 3) Press the **ENT** Key to restore (unmute) SiriusXM Audio.

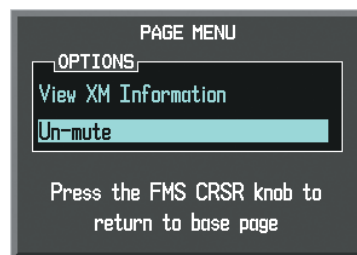

Figure 8-79 Unmuting XM Audio with the Page Menu

8.7 SCHEDULER

The Scheduler feature can be used to enter and display reminder messages (e.g., Change oil, Switch fuel tanks, or Altimeter-Transponder Check) in the Alerts Window on the PFD. Messages can be set to display based on a specific date and time (event), once the message timer reaches zero (one-time; default setting), or recurrently whenever the message timer reaches zero (periodic). Message timers set to periodic alerting automatically reset to the original timer value once the message is displayed. When power is cycled, all messages are retained until deleted, and message timer countdown is resumed.

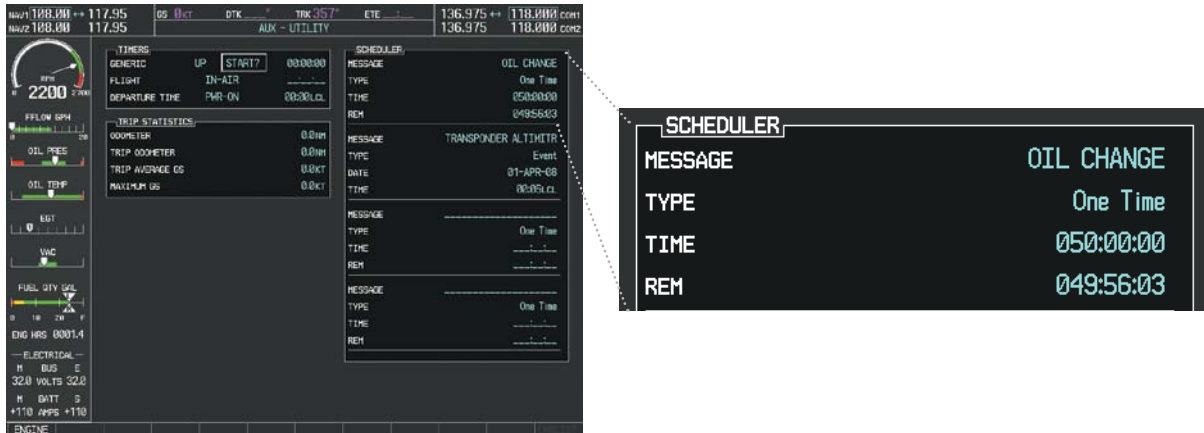

Figure 8-80 Scheduler (Utility Page)

Entering a scheduler message:

- 1) Select the AUX - Utility Page.
- 2) Press the **FMS** Knob momentarily to activate the flashing cursor.
- 3) Turn the large **FMS** Knob to highlight the first empty scheduler message naming field.
- 4) Use the **FMS** Knob to enter the message text to be displayed in the Alerts Window and press the **ENT** Key.
- 5) Press the **ENT** Key again or use the large **FMS** Knob to move the cursor to the field next to Type.
- 6) Turn the small **FMS** Knob to select the message alert type:
 - Event—Message issued at the specified date/time
 - One-time—Message issued when the message timer reaches zero (default setting)
 - Periodic—Message issued each time the message timer reaches zero
- 7) Press the **ENT** Key again or use the large **FMS** Knob to move the cursor to the next field.
- 8) For periodic and one-time message, use the **FMS** Knob to enter the timer value (HH:MM:SS) from which to countdown and press the **ENT** Key.

- 9) For event-based messages:
 - a) Use the **FMS** Knob to enter the desired date (DD-MM-YY) and press the **ENT** Key.
 - b) Press the **ENT** Key again or use the large **FMS** Knob to move the cursor to the next field.
 - c) Use the **FMS** Knob to enter the desired time (HH:MM) and press the **ENT** Key.
- 10) Press the **ENT** Key again or use the large **FMS** Knob to move the cursor to enter the next message.

Deleting a scheduler message:

- 1) Select the AUX - Utility Page.
- 2) Press the **FMS** Knob momentarily to activate the flashing cursor.
- 3) Turn the large **FMS** Knob to highlight the name field of the scheduler message to be deleted.
- 4) Press the **CLR** Key to clear the message text. If the **CLR** Key is pressed again, the message is restored.
- 5) Press the **ENT** Key while the message line is cleared to clear the message time.

Scheduler messages appear in the Alerts Window on the PFD. When a scheduler message is waiting, the **ALERTS** Softkey label changes to **ADVISORY**. Pressing the **ADVISORY** Softkey opens the Alerts Window and acknowledges the scheduler message. The softkey label reverts to **ALERTS** when pressed, the Alerts Window is removed from the display, and the scheduler message is deleted from the message queue.



Figure 8-81 PFD Alerts Window

8.8 ELECTRONIC CHECKLISTS

NOTE: The checklists presented here are for example only and may not reflect checklists actually available for the Cessna NAV III Aircraft. This material is not intended to replace the checklist information presented in the AFM or the Pilot Safety and Warning Supplements document.

NOTE: Garmin is not responsible for the content of checklists. Checklists are created by the aircraft manufacturer. Modifications or updates to the checklists are coordinated through the aircraft manufacturer. The user cannot edit these checklists.

The optional checklist functions are displayed on two levels of softkeys that are available on any MFD page.

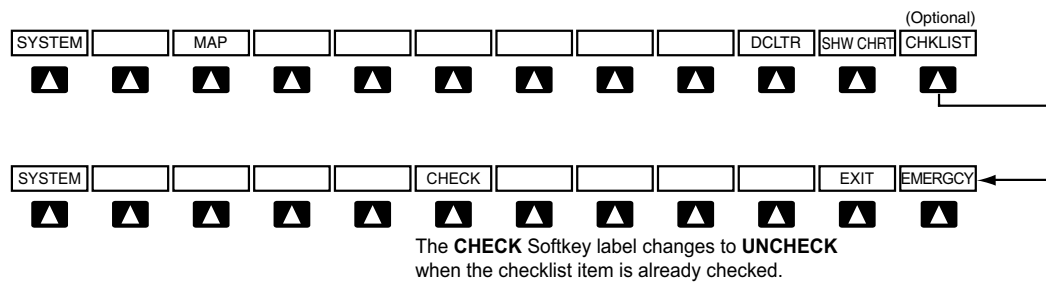

Figure 8-82 Checklist Softkeys

The MFD is able to display optional electronic checklists which allow a pilot to quickly find the proper procedure on the ground and during each phase of flight. The system accesses the checklists from an SD card inserted into the bezel slot. If the SD card contains an invalid checklist file or no checklist, the Power-up Page messages display 'Checklist File: Invalid' or 'Checklist File: N/A (not available)' and the **CHKLIST** Softkey is not available.

Accessing and navigating checklists:

- 1) From any page on the MFD, press the **CHKLIST** Softkey or turn the large **FMS** Knob to select the Checklist Page.
- 2) Turn the large **FMS** Knob to select the 'GROUP' field.
- 3) Turn the small **FMS** Knob to select the desired procedure and press the **ENT** Key.
- 4) Turn the large **FMS** Knob to select the 'CHECKLIST' field.
- 5) Turn the **FMS** Knob to select the desired checklist and press the **ENT** Key. The selected checklist item is indicated with white text surrounded by a white box.
- 6) Press the **ENT** Key or **CHECK** Softkey to check the selected checklist item. The line item turns green and a checkmark is placed in the associated box. The next line item is automatically selected for checking.

Either **FMS** Knob can be used to scroll through the checklist and select the desired checklist item.

Press the **CLR** Key or **UNCHECK** Softkey to remove a check mark from an item.

- 7) When all checklist items have been checked, '*Checklist Finished*' is displayed in green text at the bottom left of the checklist window. If all items in the checklist have not be checked, '*CHECKLIST NOT FINISHED*' will be displayed in yellow text.\

- 8) Press the **ENT** Key. 'GO TO NEXT CHECKLIST?' will be highlighted by the cursor.
- 9) Press the **ENT** Key to advance to the next checklist.
- 10) Press the **EXIT** Softkey to exit the Checklist Page and return to the page last viewed.

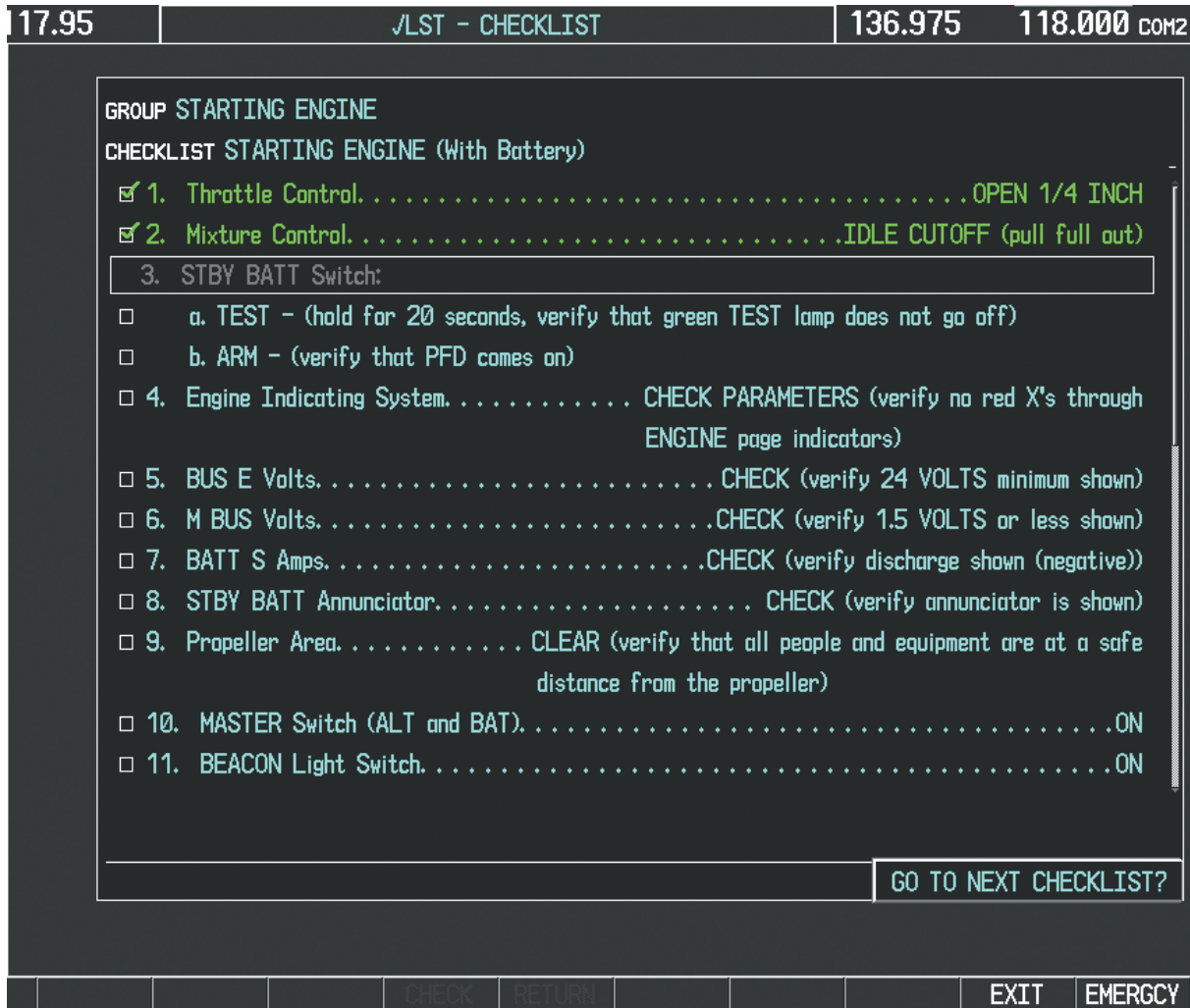

Figure 8-83 Sample Checklist

Accessing emergency procedures:

- 1) From any page on the MFD, press the **CHKLST** Softkey or turn the large **FMS** Knob to select the Checklist Page.
- 2) Press the **EMERGCY** Softkey.
- 3) Turn the **FMS** Knob to select the desired emergency checklist and press the **ENT** Key.
- 4) Press the **ENT** Key or **CHECK** Softkey to check the selected emergency checklist item. The line item turns green and a checkmark is placed in the box next to it. The next line item is automatically highlighted for checking. Either **FMS** Knob can be used to scroll through the checklist and select the desired checklist item. Press the **CLR** Key or **UNCHECK** Softkey to remove a check mark from an item.

- 5) When all checklist items have been checked, '*Checklist Finished*' is displayed in green text at the bottom left of the checklist window. If all items in the checklist have not be checked, '*CHECKLIST NOT FINISHED*' will be displayed in yellow text.\
- 6) Press the **ENT** Key. 'GO TO NEXT CHECKLIST?' will be highlighted by the cursor.
- 7) Press the **ENT** Key to advance to the next checklist.
- 8) Press the **RETURN** Softkey to return to the previous checklist.
- 9) Press the **EXIT** Softkey to exit the Checklist Page and return to the page last viewed.

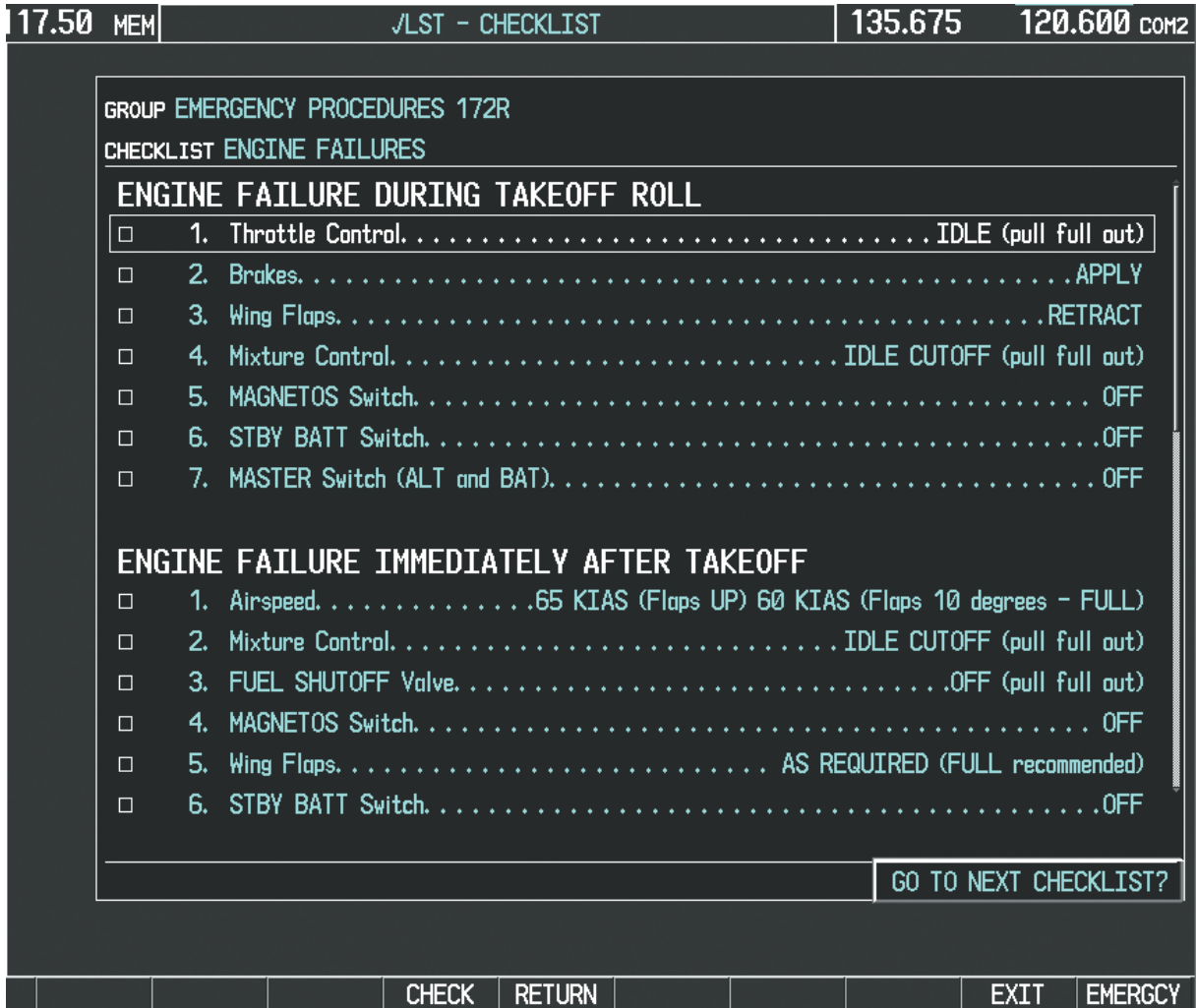

Figure 8-84 Emergency Checklist Page Example

8.9 FLIGHT DATA LOGGING



NOTE: Some aircraft installations may not provide all aircraft/engine data capable of being logged by the system.

The Flight Data Logging feature will automatically store critical flight and engine data on an SD data card inserted into the top card slot of the MFD. Approximately 4,000 flight hours can be recorded on the card.

Data is written to the SD card once each second while the MFD is powered on. All flight data logged on a specific date is stored in a file named in a format which includes that date (dataYYYY_MM_DD.csv). The file is created automatically each time the G1000 system is powered on, provided an SD card has been inserted.

The status of the Flight Data Logging feature can be viewed on the AUX-UTILITY Page. If no SD card has been inserted, “NO CARD” is displayed. When data is being written to the SD card, “LOGGING DATA” is displayed.

The .csv file may be viewed with Microsoft Excel® or other spreadsheet applications.

The following is a list of data parameters the G1000 system is capable of logging for the Cessna Nav III aircraft.

- Date
- Time
- GPS altitude (MSL)
- GPS altitude (WGS84 datum)
- Baro-Corrected altitude (feet)
- Baro Correction (in/Hg)
- Indicated airspeed (kts)
- Vertical speed (fpm)
- GPS vertical speed (fpm)
- OAT (degrees C)
- True airspeed (knots)
- Pitch Attitude Angle (degrees)
- Roll Attitude Angle (degrees)
- Lateral and Vertical G Force (g)
- Ground Speed (kts)
- Ground Track (degrees magnetic)
- Latitude (degrees; geodetic; +North)
- Longitude (degrees; geodetic; +East)
- Magnetic Heading (degrees)
- HSI source
- Selected course
- Com1/Com2 frequency
- Nav1/Nav2 frequency
- CDI deflection
- VDI/GP/GS deflection
- Wind Direction (degrees)
- Wind Speed (knots)
- Active Waypoint Identifier
- Distance to next waypoint (nm)
- Bearing to next waypoint (degrees)
- Magnetic variation (degrees)
- Autopilot On/Off
- AFCS roll/pitch modes
- AFCS roll/pitch commands
- GPS fix
- GPS horizontal alert limit
- GPS vertical alert limit
- SBAS GPS horizontal protection level
- SBAS GPS vertical protection level
- Fuel Qty (right & left)(gals)
- Fuel Flow (gph)
- Fuel Pressure (psi)
- Voltage 1 and/or 2
- Amps 1 and/or 2
- Engine RPM
- Oil Pressure (psi)
- Oil Temperature (deg. F)
- TIT (deg. F)
- Manifold Pressure (in. Hg)
- CHT
- EGT

The file containing the recorded data will appear in the format shown in Figure 8-85. This file can be imported into most computer spreadsheet applications.

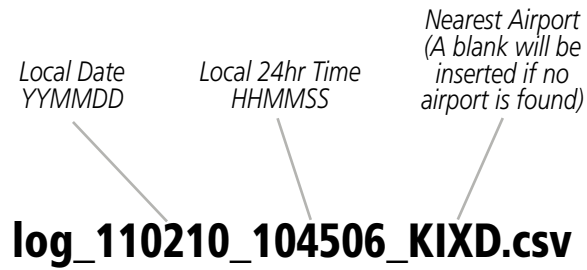

Figure 8-85 Log File Format

Data logging status can be monitored on the AUX-UTILITY Page.

8.10 AUXILIARY VIDEO (OPTIONAL)

The G1000 system provides a control and display interface to an optional auxiliary video system. The system can display video for up to two inputs.

There are four modes of operation of the auxiliary video display: Full-Screen, Full-Screen with Digital Zoom, Split-Screen with Map, and Split-Screen with Map and Digital Zoom.

Displaying auxiliary video:

- 1) Turn the large **FMS** Knob to select the AUX page group.
- 2) Turn the small **FMS** Knob to select VIDEO and display the AUX-VIDEO Page.

The video display softkeys shown below appear on the AUX - VIDEO Page.

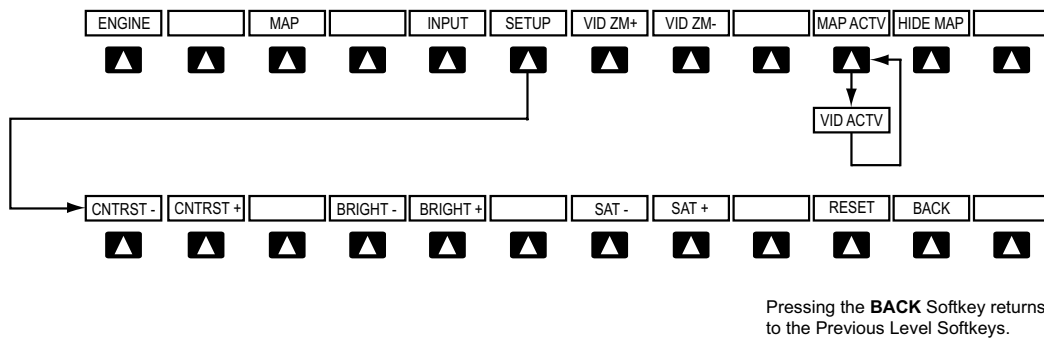

Figure 8-86 Video Display Softkeys

Control of the AUX - VIDEO Page can also be accessed through the Page Menu.



Figure 8-87 AUX - VIDEO Page Menu

Selecting video menu options:

- 1) While viewing the AUX - VIDEO Page press the **MENU** Key to display the Page Menu OPTIONS.
- 2) Turn the large **FMS** Knob to highlight the desired video adjustment option and press the **ENT** Key.

Once the **ENT** key is pressed on any option, the page menu closes and returns to the AUX - VIDEO Page.

VIDEO SETUP

Video brightness, contrast, and saturation may be adjusted by selecting the setup function. While viewing the setup function softkeys, after 45 seconds of softkey inactivity, the system reverts to the AUX - VIDEO Page softkeys.

Adjusting the video settings:

- 1) With the AUX-VIDEO Page displayed, press the **SETUP** Softkey.
- 2) Press the **BRIGHT -** or **BRIGHT +**, to adjust display brightness in five percent increments from 0 to 100%.
- 3) Press the **CNTRST-** or **CNTRST +**, to adjust display contrast in five percent increments from 0 to 100%.
- 4) Press the **SAT -** or **SAT +**, to adjust display saturation in five percent increments from 0 to 100%.
- 5) If desired, return the display to the default settings by pressing the **RESET** Softkey.
- 6) Press the **BACK** Softkey to return to the previous softkey level.

DISPLAY SELECTION

Pressing the **HIDE MAP** Softkey removes the map and displays video on the full screen. The softkey label changes to grey with black characters. Pressing the **HIDE MAP** Softkey again restores the map view and the small video image. The softkey label returns to white characters on a black background.

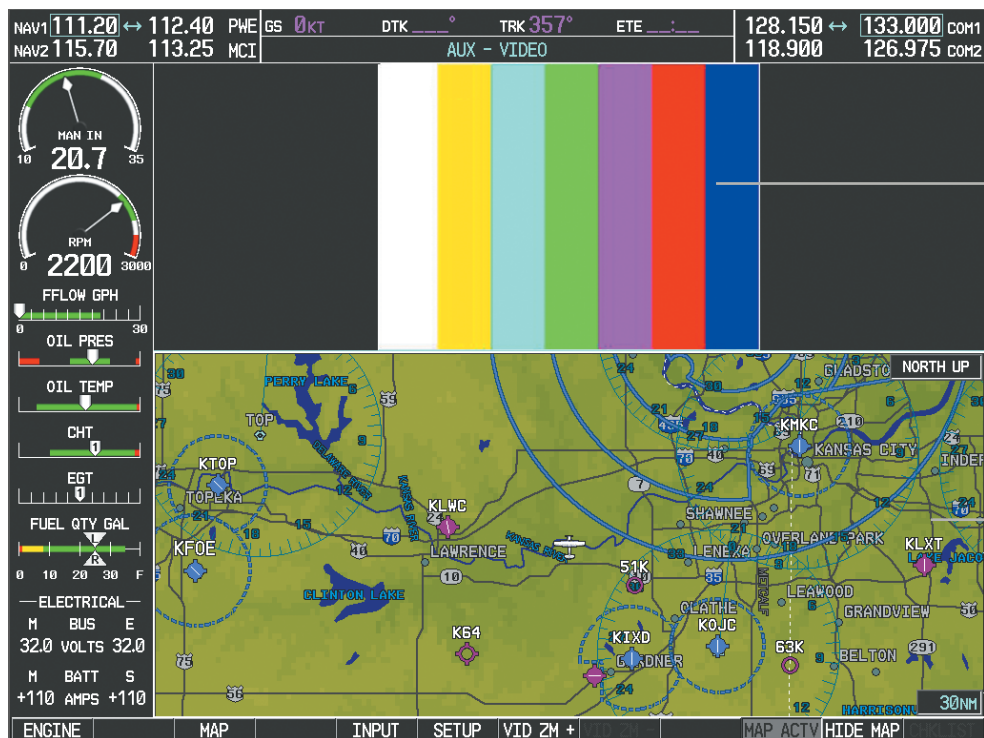

Video Display

Map View

Figure 8-88 AUX - Video Split-Screen

SYSTEM OVERVIEW

FLIGHT INSTRUMENTS

EIS

AUDIO PANEL & CNS

FLIGHT MANAGEMENT

HAZARD AVOIDANCE

AFCS

ADDITIONAL FEATURES

APPENDICES

INDEX

- SYSTEM OVERVIEW
- FLIGHT INSTRUMENTS
- EIS
- AUDIO PANEL & CNS
- FLIGHT MANAGEMENT
- HAZARD AVOIDANCE
- AFCS
- ADDITIONAL FEATURES
- APPENDICES
- INDEX

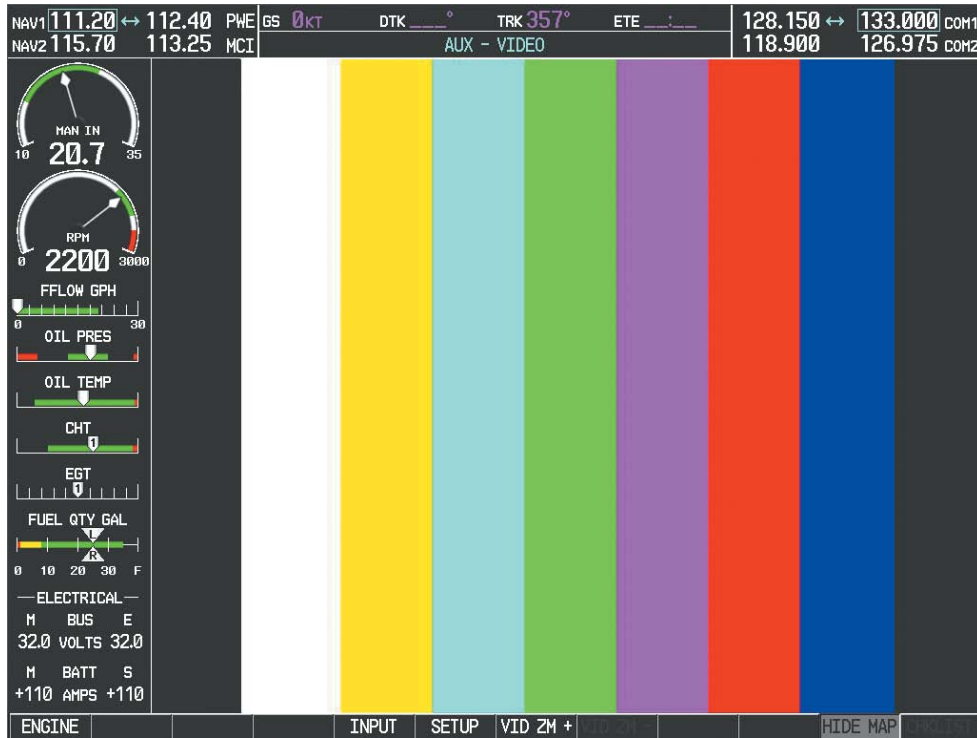

Figure 8-89 Full Screen Video Display

INPUT SELECTION

While on the AUX - VIDEO Page, press the **INPUT** Softkey to select the EVS or AUX video source.

ZOOM/RANGE

Pressing the **VID ZM +** or **VID ZM -** Softkeys increases or decreases video display magnification between 1x and 10x.

The **RANGE** Knob can be used to increase or decrease the range setting on the map display or zoom in and out on the video display. While in the Split-Screen mode, pressing the **MAP ACTV** or **VID ACTV** Softkey determines which display the **RANGE** Knob adjusts. Pressing the softkey to display MAP ACTV allows the **RANGE** Knob to control the range setting of the map display. Pressing the softkey to display VID ACTV allows the **RANGE** Knob to control the zoom setting of the video display.

When zooming in on the video display, a Zoom Window will appear in the upper right of the display. A box within this window indicates the portion of the display currently being viewed. The currently displayed portion of the full display may be adjusted by using Joystick.

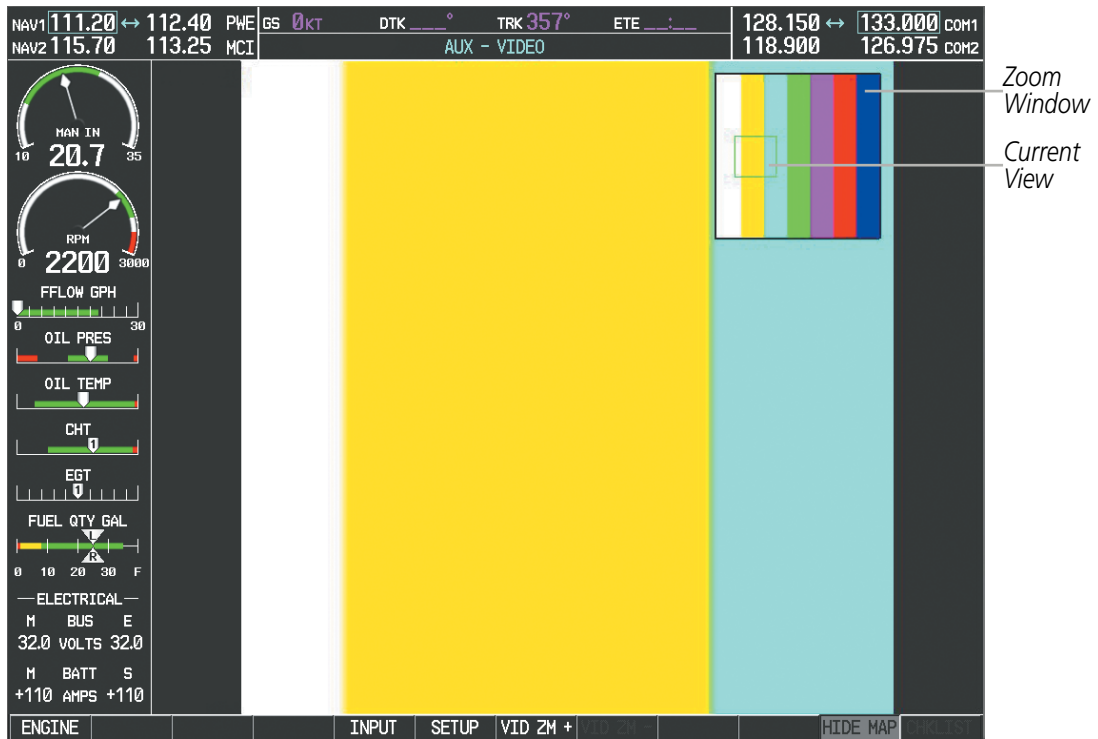

Figure 8-90 Zoom Window

8.11 ABNORMAL OPERATION

SVS TROUBLESHOOTING

SVS is intended to be used with traditional attitude, heading, obstacle, terrain, and traffic inputs. SVS is disabled when valid attitude or heading data is not available for the display. In case of invalid SVS data, the PFD display reverts to the standard blue-over-brown attitude display.

SVS becomes disabled without the following data resources:

- Attitude data
- Heading data
- GPS position data
- 9 Arc-second Terrain data
- Obstacle data
- TAWS function is not available, in test mode, or failed
- The position of the aircraft exceeds the range of the terrain database.

REVERSIONARY MODE

SVS can be displayed on the Multifunction Display (MFD) in Reversionary Mode. If it is enabled when switching to Reversionary Mode, SVS will take up to 30 seconds to be displayed. The standard, non-SVS PFD display will be shown in the interim.



Figure 8-91 SVS Reversionary Mode

UNUSUAL ATTITUDES

Unusual attitudes are displayed with red chevrons overlaid on the display indicating the direction to fly to correct the unusual attitude condition. The display shows either a brown or blue colored bar at the top or bottom of the screen to represent earth or sky. This is intended to prevent losing sight of the horizon during extreme pitch attitudes.

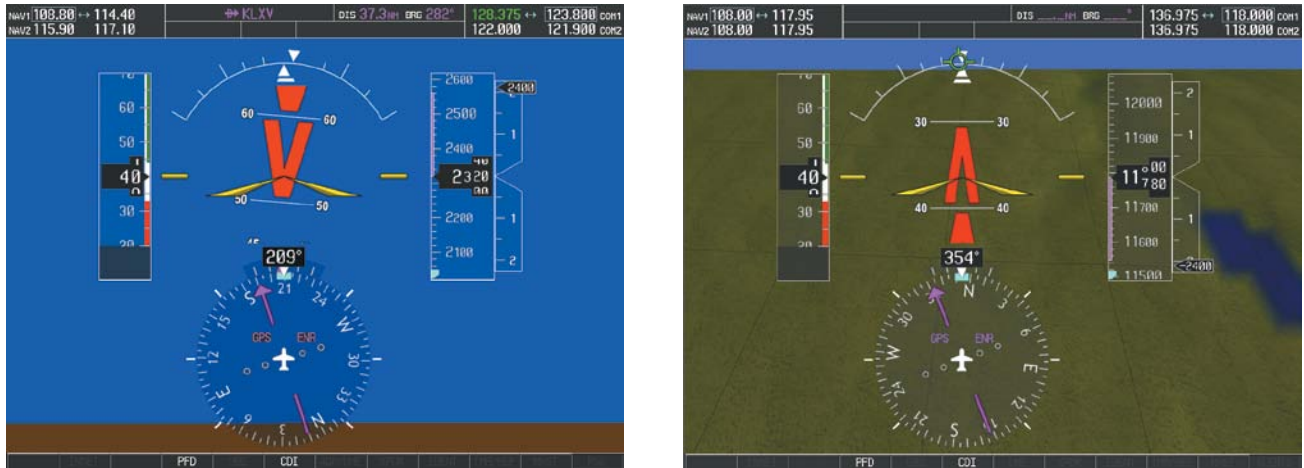

Figure 8-92 Unusual Attitude Display

The blue colored bar is also displayed when terrain gradient is great enough to completely fill the display.



Figure 8-93 Blue Sky Bar with Full Display Terrain

GDL 69/69A DATA LINK RECEIVER TROUBLESHOOTING

Some quick troubleshooting steps listed below can be performed to find the possible cause of a failure.

- Ensure the owner/operator of the aircraft in which the Data Link Receiver is installed has subscribed to SiriusXM services
- Ensure the SiriusXM subscription has been activated
- Perform a quick check of the circuit breakers to ensure that power is applied to the Data Link Receiver

For troubleshooting purposes, check the LRU Information Box on the AUX - System Status Page for Data Link Receiver (GDL 69/69A) status, serial number, and software version number. If a failure has been detected in the GDL 69/69A the status is marked with a red X.

Selecting the System Status Page:

- 1) Turn the large **FMS** Knob to select the AUX Page Group.
- 2) Turn the small **FMS** Knob to select the System Status Page (the last page in the AUX Page Group).

LRU INFO			
	STATUS	SERIAL NUMBER	VERSION
COM1	✓		7.00
COM2	✓		7.00
GDC1	✓	47801548	1.05
GDL69	✓	47750372	3.02.00
GEA1	✓	46701911	2.07
GIA1	✓	0000001	0.50
GIA2	✓	48400000	3.01
GMA1	✓	48400001	3.01
GMU1	✓	47500607	2.01
GPS1	✓	0000001	0.50
GPS2	✓	0000002	0.50
GRS1	✗	-----	----
GS1	✗	-----	----
GS2	✗	-----	----
GTX1	✗	-----	----
MFD1	✓	0000002	8.20

Figure 8-94 LRU Information Window on System Status Page

If a failure still exists, the following messages may provide insight as to the possible problem:

Message	Message Location	Description
CHECK ANTENNA	XM Radio Page - active channel field	Data Link Receiver antenna error; service required
UPDATING	XM Radio Page - active channel field	Data Link Receiver updating encryption code
NO SIGNAL	XM Radio Page - active channel field Weather Datalink Page - center of page	Loss of signal; signal strength too low for receiver
LOADING	XM Radio Page - active channel field	Acquiring channel audio or information
OFF AIR	XM Radio Page - active channel field	Channel not in service
---	XM Radio Page - active channel field	Missing channel information
WEATHER DATA LINK FAILURE	Weather Datalink Page - center of page	No communication from Data Link Receiver within last 5 minutes
ACTIVATION REQUIRED	Weather Datalink Page - center of page	SiriusXM subscription is not activated

Table 8-5 GDL 69/69A Data Link Receiver Error Messages

SYSTEM OVERVIEW

FLIGHT INSTRUMENTS

EIS

AUDIO PANEL & CNS

FLIGHT MANAGEMENT

HAZARD AVOIDANCE

AFCS

ADDITIONAL FEATURES

APPENDICES

INDEX

BLANK PAGE

ANNUNCIATIONS AND ALERTS



NOTE: The Cessna aircraft Pilot's Operating Handbook (POH) supersedes information found in this document.

The G1000 Alerting System conveys alerts to the pilot using a combination of the following items:

- **Annunciation Window:** The Annunciation Window displays abbreviated annunciation text. Text color is based on alert levels described later in the Alert Levels Definitions section. The Annunciation Window is located to the right of the Altimeter and Vertical Speed Indicator on the display. All Cessna Nav III annunciations can be displayed simultaneously in the Annunciation Window. A white horizontal line separates annunciations that are acknowledged from annunciations that are not yet acknowledged. Higher priority annunciations are displayed towards the top of the window. Lower priority annunciations are displayed towards the bottom of the window.
- **Alerts Window:** The Alerts Window displays alert text messages. Up to 64 prioritized alert messages can be displayed in the Alerts Window. Pressing the **ALERTS** Softkey displays the Alerts Window. Pressing the **ALERTS** Softkey a second time removes the Alerts Window from the display. When the Alerts Window is displayed, the pilot can use the large **FMS** Knob to scroll through the alert message list.
- **Softkey Annunciation:** During certain alerts, the **ALERTS** Softkey may appear as a flashing annunciation to accompany an alert. The **ALERTS** Softkey assumes a new label consistent with the alert level (WARNING, CAUTION, or ADVISORY). By pressing the softkey annunciation, the pilot acknowledges awareness of the alert. The softkey then returns to the previous **ALERTS** label. If alerts are still present, the **ALERTS** label is displayed in inverse video (white background with black text). The pilot can press the **ALERTS** Softkey a second time to view alert text messages.
- **System Annunciations:** Typically, a large red 'X' appears in windows when a failure is detected in the LRU providing the information to the window. See the G1000 System Annunciations section for more information.
- **Audio Alerting System:** The G1000 system issues audio alert tones when specific system conditions are met. See the Alert Levels Definitions section for more information.

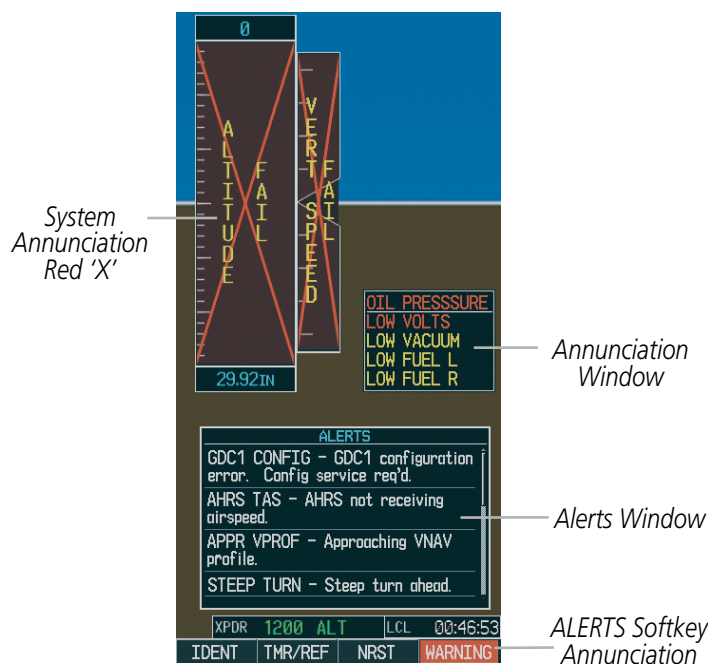

Figure A-1 G1000 Alerting System

ALERT LEVEL DEFINITIONS

The G1000 Alerting System, as installed in Cessna Nav III aircraft, uses three alert levels.

- **WARNING:** This level of alert requires immediate pilot attention. A warning alert is annunciated in the Annunciation Window and is accompanied by a continuous aural tone. Text appearing in the Annunciation Window is RED. A warning alert is also accompanied by a flashing **WARNING** Softkey annunciation, as shown in Figure A-2. Pressing the **WARNING** Softkey acknowledges the presence of the warning alert and stops the aural tone, if applicable.
- **CAUTION:** This level of alert indicates the existence of abnormal conditions on the aircraft that may require pilot intervention. A caution alert is annunciated in the Annunciation Window and is accompanied by a single aural tone. Text appearing in the Annunciation Window is YELLOW. A caution alert is also accompanied by a flashing **CAUTION** Softkey annunciation, as shown in Figure A-3. Pressing the **CAUTION** Softkey acknowledges the presence of the caution alert.
- **MESSAGE ADVISORY:** This level of alert provides general information to the pilot. A message advisory alert does not issue annunciations in the Annunciation Window. Instead, message advisory alerts only issue a flashing **ADVISORY** Softkey annunciation, as shown in Figure A-4. Pressing the **ADVISORY** Softkey acknowledges the presence of the message advisory alert and displays the alert text message in the Alerts Window.



Figure A-2 WARNING Softkey Annunciation



Figure A-3 CAUTION Softkey Annunciation



Figure A-4 ADVISORY Softkey Annunciation

NAV III AIRCRAFT ALERTS

The following alerts are configured specifically for the Cessna Nav III aircraft. See the Cessna Pilot's Operating Handbook (POH) for information regarding pilot responses.

WARNING ALERTS

Annunciation Window Text	Audio Alert
CO LVL HIGH HIGH VOLTS LOW VOLTS* OIL PRESSURE PITCH TRIM**	Continuous Aural Tone
	No Tone

* Aural tone is inhibited while the aircraft is on the ground.

** KAP 140 installations only

CAUTION ALERTS

Annunciation Window Text	Audio Alert
<p>LOW FUEL L LOW FUEL R LOW VACUUM STBY BATT</p>	Single Aural Tone

CAUTION ALERTS (T182, T206, AND 206 WITH PROP DE-ICE ONLY)

Annunciation Window Text	Audio Alert
PROP HEAT	Single Aural Tone

SAFE OPERATING ANNUNCIATION (T182, T206, AND 206 WITH PROP DE-ICE ONLY)

Annunciation Window Text	Audio Alert
PROP HEAT	No Tone

CO GUARDIAN MESSAGES

Alerts Window Message	Comments
CO DET SRVC – The carbon monoxide detector needs service.	There is a problem within the CO Guardian that requires services.
CO DET FAIL – The carbon monoxide detector is inoperative.	Loss of communication between the G1000 and the CO Guardian.

G1000 SYSTEM ANNUNCIATIONS

When a new alert is issued, the **ALERT** Softkey flashes to alert the pilot of a new message. It continues to flash until acknowledged by pressing the softkey. Active alerts are displayed in white text. Alerts that have become inactive change to gray text. The **ALERT** Softkey flashes if the state of a displayed alert changes or a new alert is displayed. The inactive alerts can be removed from the Alert Window by pressing the flashing **ALERT** Softkey.

The G1000 System Messages convey messages to the pilot regarding problems with the G1000 system. When an LRU or an LRU function fails, a large red 'X' is typically displayed on windows associated with the failed data. The following section describes various system annunciations. Refer to the POH for additional information regarding pilot responses to these annunciations.



NOTE: Upon power-up of the G1000 system, certain windows remain invalid as G1000 equipment begins to initialize. All windows should be operational within one minute of power-up. Should any window continue to remain flagged, the G1000 system should be serviced by a Garmin-authorized repair facility.

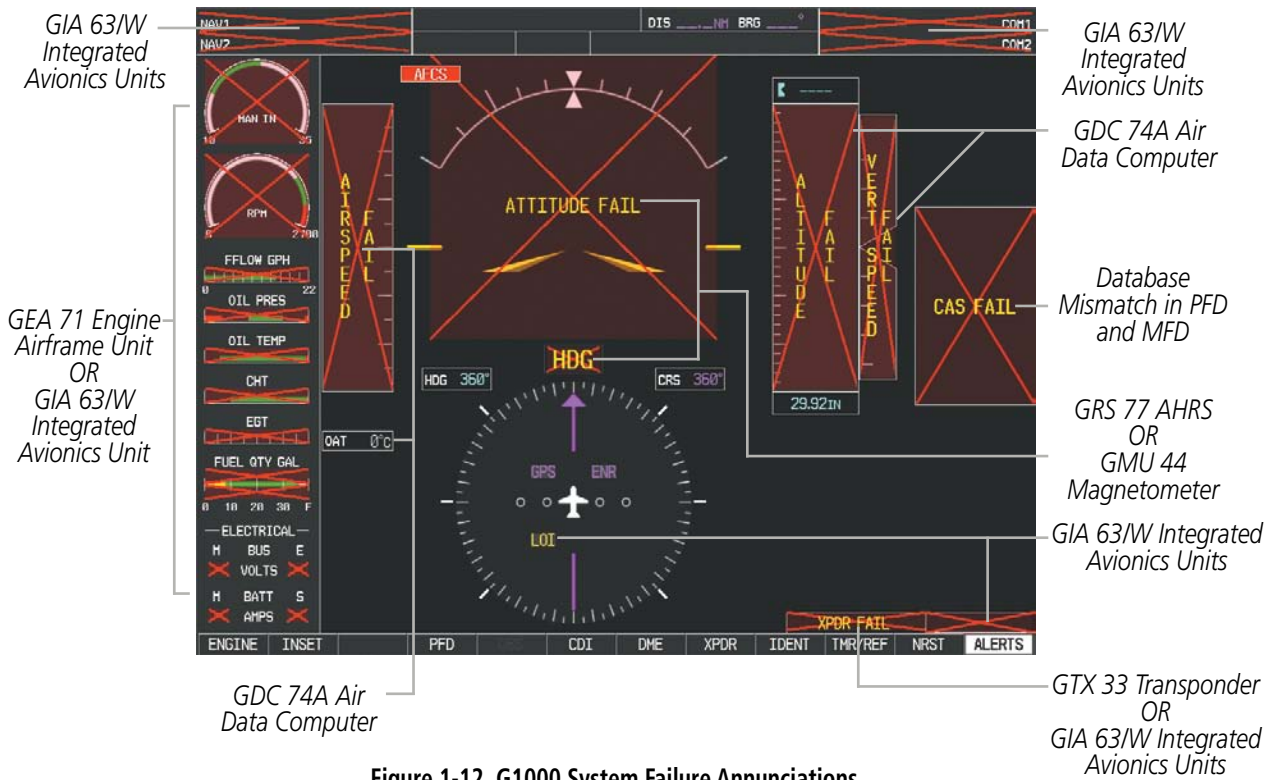





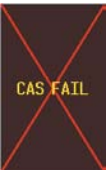



Figure 1-12 G1000 System Failure Annunciations



NOTE: Upon power-up, certain windows remain invalid as G1000 equipment begins to initialize. All windows should be operational within one minute of power-up. If any window continues to remain flagged, the G1000 System should be serviced by a Garmin-authorized repair facility.

System Annunciation	Comment
	Attitude and Heading Reference System is aligning.
	Display system is not receiving attitude information from the AHRS.
	Indicates a configuration module failure.

System Annunciation	Comment
	<p>This annunciation is only seen when the autopilot is engaged. The annunciation indicates an AHRS monitor has detected an abnormal flight parameter, possibly caused by strong turbulence. In this case, the situation should correct itself within a few seconds. If there is an actual failure, a red "X" soon appears over the Attitude Indicator.</p>
	<p>Display system is not receiving airspeed input from air data computer.</p>
	<p>Display is not receiving altitude input from the air data computer.</p>
	<p>Display is not receiving vertical speed input from the air data computer.</p>
	<p>Display is not receiving valid heading input from AHRS.</p>
	<p>Different versions of GDU software are installed in the PFD and MFD. This can also indicate different versions of navigation software are installed in the PFD and MFD. In some circumstances, a cross-talk error between the PFD and MFD can cause this annunciation.</p>
	<p>'LOI' Indicates Loss of Integrity of GPS information. GPS information is either not present or is invalid for navigation use. 'DR' may also be seen indicating that GPS is in Dead Reckoning Mode. Note that AHRS utilizes GPS inputs during normal operation. AHRS operation may be degraded if GPS signals are not present (see AFMS).</p>
	<p>Display is not receiving valid transponder information.</p>
<p>Other Various Red X Indications</p>	<p>A red 'X' through any other display field, such as engine instrumentation fields, indicates that the field is not receiving valid data.</p>

OTHER G1000 AURAL ALERTS

The following voice alerts can be configured for 'Male' or 'Female' gender by using the Aux System Setup Page on the MFD.

Aural Alert	Description
"Minimums, minimums"	The aircraft has descended below the preset barometric minimum descent altitude.
"Vertical track"	The aircraft is one minute from Top of Descent. Issued only when vertical navigation is enabled.
"Traffic"	The Traffic Information Service (TIS) or ADS-B traffic system has issued a Traffic Advisory alert
"Traffic not available"	The aircraft is outside the Traffic Information Service (TIS) or ADS-B coverage area.
"Traffic, Traffic"	Played when a Traffic Advisory (TA) is issued with a TAS system.
"TAS System Test OK"	Played when the TAS system passes a pilot-initiated self test.
"TAS System Test Failed"	Played when the TAS system fails a pilot-initiated self test.



NOTE: Voice alerts are provided to the G1000 by GIA 63/W #1. Should this unit fail, audio and voice alerts are no longer available.

G1000 SYSTEM MESSAGE ADVISORIES

This section describes various G1000 system message advisories. Certain messages are issued due to an LRU or an LRU function failure. Such messages are normally accompanied by a corresponding red 'X' annunciation as shown previously in the G1000 System Annunciation section.



NOTE: This Section provides information regarding G1000 message advisories that may be displayed by the system. Knowledge of the aircraft, systems, flight conditions, and other existing operational priorities must be considered when responding to a message. Always use sound pilot judgment. The Cessna Nav III Pilot's Operating Handbook (POH) takes precedence over any conflicting guidance found in this section.

MFD & PFD MESSAGE ADVISORIES

Message	Comments
DATA LOST – Pilot stored data was lost. Recheck settings.	The pilot profile data was lost. System reverts to default pilot profile and settings. The pilot may reconfigure the MFD & PFDs with preferred settings, if desired.
XTALK ERROR – A flight display crosstalk error has occurred.	The MFD and PFD are not communicating with each other. The system should be serviced.
PFD1 SERVICE – PFD1 needs service. Return unit for repair.	The PFD and/or MFD self-test has detected a problem. The system should be serviced.
MFD1 SERVICE – MFD1 needs service. Return unit for repair.	
MANIFEST – PFD1 software mismatch, communication halted.	The PFD and/or MFD has incorrect software installed. The system should be serviced.
MANIFEST – MFD1 software mismatch, communication halted.	
PFD1 CONFIG – PFD1 config error. Config service req'd.	The PFD configuration settings do not match backup configuration memory. The system should be serviced.
MFD1 CONFIG – MFD1 config error. Config service req'd.	The MFD configuration settings do not match backup configuration memory. The system should be serviced.

MFD & PFD MESSAGE ADVISORIES (CONT.)

Message	Comments
SW MISMATCH – GDU software version mismatch. Xtalk is off.	The MFD and PFD have different software versions installed. The system should be serviced.
PFD1 COOLING – PFD1 has poor cooling. Reducing power usage.	The PFD and/or MFD is overheating and is reducing power consumption by dimming the display. If problem persists, the system should be serviced.
MFD1 COOLING – MFD1 has poor cooling. Reducing power usage.	
PFD1 KEYSTK – PFD1 [key name] Key is stuck.	A key is stuck on the PFD and/or MFD bezel. Attempt to free the stuck key by pressing it several times. The system should be serviced if the problem persists.
MFD1 KEYSTK – MFD [key name] Key is stuck.	
CNFG MODULE – PFD1 configuration module is inoperative.	The PFD1 configuration module backup memory has failed. The system should be serviced.
PFD1 VOLTAGE – PFD1 has low voltage. Reducing power usage	The PFD1 voltage is low. The system should be serviced.
MFD1 VOLTAGE – MFD1 has low voltage. Reducing power usage	The MFD voltage is low. The system should be serviced.

DATABASE MESSAGE ADVISORIES

Message	Comments
MFD1 DB ERR – MFD1 navigation database error exists.	The MFD and/or PFD detected a failure in the navigation database. Attempt to reload the navigation database. If problem persists, the system should be serviced.
PFD1 DB ERR – PFD1 navigation database error exists.	
MFD1 DB ERR – MFD1 basemap database error exists.	The MFD and/or PFD detected a failure in the basemap database.
PFD1 DB ERR – PFD1 basemap database error exists.	
MFD1 DB ERR – MFD1 terrain database error exists.	The MFD and/or PFD detected a failure in the terrain database. Ensure that the terrain card is properly inserted in display. Replace terrain card. If problem persists, the system should be serviced.
PFD1 DB ERR – PFD1 terrain database error exists.	
MFD1 DB ERR – MFD1 terrain database missing.	The terrain database is present on another LRU, but is missing on the specified LRU.
PFD1 DB ERR – PFD1 terrain database missing.	
MFD1 DB ERR – MFD1 obstacle database error exists.	The MFD and/or PFD detected a failure in the obstacle database. Ensure that the data card is properly inserted. Replace data card. If problem persists, the system should be serviced.
PFD1 DB ERR – PFD1 obstacle database error exists.	

DATABASE MESSAGE ADVISORIES (CONT.)

Message	Comments
MFD1 DB ERR – MFD1 obstacle database missing.	The obstacle database is present on another LRU, but is missing on the specified LRU.
PFD1 DB ERR – PFD1 obstacle database missing.	
MFD1 DB ERR – MFD1 airport terrain database error exists.	The MFD and/or PFD detected a failure in the airport terrain database. Ensure that the data card is properly inserted. Replace data card. If problem persists, the system should be serviced.
PFD1 DB ERR – PFD1 airport terrain database error exists.	
MFD1 DB ERR – MFD1 airport terrain database missing.	The airport terrain database is present on another LRU, but is missing on the specified LRU.
PFD1 DB ERR – PFD1 airport terrain database missing.	
MFD1 DB ERR – MFD1 Safe Taxi database error exists.	The MFD and/or PFD detected a failure in the Safe Taxi database. Ensure that the data card is properly inserted. Replace data card. If problem persists, the system should be serviced.
PFD1 DB ERR – PFD1 Safe Taxi database error exists.	
MFD1 DB ERR – MFD1 Chartview database error exists.	The MFD detected a failure in the ChartView database (optional feature). Ensure the data card is properly inserted. Replace data card. If problem persists, system should be serviced.
MFD1 DB ERR – MFD1 FliteCharts database error exists.	The MFD detected a failure in the FliteCharts database (optional feature). Ensure the data card is properly inserted. Replace data card. If problem persists, system should be serviced.
MFD1 DB ERR – MFD1 Airport Directory database error exists.	The MFD detected a failure in the Airport Directory database. Ensure that the data card is properly inserted. Replace data card. If problem persists, the system should be serviced.
DB MISMATCH – Navigation database mismatch. Xtalk is off.	The PFD and MFD have different navigation database versions or types (Americas, European, etc.) installed. Crossfill is off. Install correct navigation database version or type in all displays.
DB MISMATCH – Standby Navigation database mismatch.	The PFD and MFD have different standby navigation database versions or types (Americas, European, etc.) installed. Install correct standby navigation database version or type in all displays.
DB MISMATCH – Terrain database mismatch.	The PFD and MFD have different terrain database versions or types installed. Install correct terrain database version or type in all displays.
DB MISMATCH – Obstacle database mismatch.	The PFD and MFD have different obstacle database installed. Install correct obstacle database in all displays.
DB MISMATCH – Airport Terrain database mismatch.	The PFD and MFD have different airport terrain databases installed. Install correct airport terrain database in all displays.
NAV DB UPDATED – Active navigation database updated.	System has updated the active navigation database from the standby navigation database.
TERRAIN DSP – [PFD1 or MFD1] Terrain awareness display unavailable.	One of the terrain, airport terrain, or obstacle databases required for TAWS in the specified PFD or MFD is missing or invalid.

GMA 1347 MESSAGE ADVISORIES

Message	Comments
GMA1 FAIL – GMA1 is inoperative.	The audio panel self-test has detected a failure. The audio panel is unavailable. The system should be serviced.
GMA1 CONFIG – GMA1 config error. Config service req'd.	The audio panel configuration settings do not match backup configuration memory. The system should be serviced.
MANIFEST – GMA1 software mismatch, communication halted.	The audio panel has incorrect software installed. The system should be serviced.
GMA1 SERVICE – GMA1 needs service. Return unit for repair.	The audio panel self-test has detected a problem in the unit. Certain audio functions may still be available, and the audio panel may still be usable. The system should be serviced when possible.

GIA 63 MESSAGE ADVISORIES

Message	Comments
GIA1 CONFIG – GIA1 config error. Config service req'd.	The GIA1 and/or GIA2 configuration settings do not match backup configuration memory. The G1000 system should be serviced.
GIA2 CONFIG – GIA2 config error. Config service req'd.	
GIA1 CONFIG – GIA1 audio config error. Config service req'd.	The GIA1 and/or GIA2 have an error in the audio configuration. The G1000 system should be serviced.
GIA2 CONFIG – GIA2 audio config error. Config service req'd.	
GIA1 COOLING – GIA1 temperature too low.	The GIA1 and/or GIA2 temperature is too low to operate correctly. Allow units to warm up to operating temperature.
GIA2 COOLING – GIA2 temperature too low.	
GIA1 COOLING – GIA1 over temperature.	The GIA1 and/or GIA2 temperature is too high. If problem persists, the G1000 system should be serviced.
GIA2 COOLING – GIA2 over temperature.	
GIA1 SERVICE – GIA1 needs service. Return the unit for repair.	The GIA1 and/or GIA2 self-test has detected a problem in the unit. The G1000 system should be serviced.
GIA2 SERVICE – GIA2 needs service. Return the unit for repair.	
MANIFEST – GIA1 software mismatch, communication halted.	The GIA1 and/or GIA 2 has incorrect software installed. The G1000 system should be serviced.
MANIFEST – GIA2 software mismatch, communication halted.	
COM1 TEMP – COM1 over temp. Reducing transmitter power.	The system has detected an over temperature condition in COM1 and/or COM2. The transmitter is operating at reduced power. If the problem persists, the G1000 system should be serviced.
COM2 TEMP – COM2 over temp. Reducing transmitter power.	

GIA 63 MESSAGE ADVISORIES (CONT.)

Message	Comments
COM1 SERVICE – COM1 needs service. Return unit for repair.	The system has detected a failure in COM1 and/or COM2. COM1 and/or COM2 may still be usable. The G1000 system should be serviced when possible.
COM2 SERVICE – COM2 needs service. Return unit for repair.	
COM1 PTT – COM1 push-to-talk key is stuck.	The COM1 and/or COM2 external push-to-talk switch is stuck in the enable (or “pressed”) position. Press the PTT switch again to cycle its operation. If the problem persists, the G1000 system should be serviced.
COM2 PTT – COM2 push-to-talk key is stuck.	
COM1 RMT XFR – COM1 remote transfer key is stuck.	The COM1 and/or COM2 transfer switch is stuck in the enabled (or “pressed”) position. Press the transfer switch again to cycle its operation. If the problem persists, the G1000 system should be serviced.
COM2 RMT XFR – COM2 remote transfer key is stuck.	
RAIM UNAVAIL – RAIM is not available from FAF to MAP waypoints.	GPS satellite coverage is insufficient to perform Receiver Autonomous Integrity Monitoring (RAIM) from the FAF to the MAP waypoints.
LOI – GPS integrity lost. Crosscheck with other NAVS.	Loss of GPS integrity monitoring.
GPS NAV LOST – Loss of GPS navigation. Insufficient satellites.	Loss of GPS navigation due to insufficient satellites.
GPS NAV LOST – Loss of GPS navigation. Position error.	Loss of GPS navigation due to position error.
GPS NAV LOST – Loss of GPS navigation. GPS fail.	Loss of GPS navigation due to GPS failure.
ABORT APR – Loss of GPS navigation. Abort approach.	Abort approach due to loss of GPS navigation.
TRUE APR – True north approach. Change hdg reference to TRUE.	Displayed after passing the first waypoint of a true north approach when the nav angle is set to ‘AUTO’.
GPS1 FAIL – GPS1 is inoperative.	A failure has been detected in the GPS1 and/or GPS2 receiver. The receiver is unavailable. The G1000 system should be serviced.
GPS2 FAIL – GPS2 is inoperative.	
GPS1 SERVICE – GPS1 needs service. Return unit for repair.	A failure has been detected in the GPS1 and/or GPS2 receiver. The receiver may still be available. The G1000 system should be serviced.
GPS2 SERVICE – GPS2 needs service. Return unit for repair.	
NAV1 SERVICE – NAV1 needs service. Return unit for repair.	A failure has been detected in the NAV1 and/or NAV2 receiver. The receiver may still be available. The G1000 system should be serviced.
NAV2 SERVICE – NAV2 needs service. Return unit for repair.	

SYSTEM OVERVIEW
 FLIGHT INSTRUMENTS
 EIS
 AUDIO PANEL & CNS
 FLIGHT MANAGEMENT
 HAZARD AVOIDANCE
 AFCS
 ADDITIONAL FEATURES
 APPENDICES
 INDEX

GIA 63 MESSAGE ADVISORIES (CONT.)

Message	Comments
NAV1 RMT XFR – NAV1 remote transfer key is stuck.	The remote NAV1 and/or NAV2 transfer switch is stuck in the enabled (or “pressed”) state. Press the transfer switch again to cycle its operation. If the problem persists, the G1000 system should be serviced.
NAV2 RMT XFR – NAV2 remote transfer key is stuck.	
G/S1 FAIL – G/S1 is inoperative.	A failure has been detected in glideslope receiver 1 and/or receiver 2. The G1000 system should be serviced.
G/S2 FAIL – G/S2 is inoperative.	
G/S1 SERVICE – G/S1 needs service. Return unit for repair.	A failure has been detected in glideslope receiver 1 and/or receiver 2. The receiver may still be available. The G1000 system should be serviced when possible.
G/S2 SERVICE – G/S2 needs service. Return unit for repair.	

GIA 63W MESSAGE ADVISORIES

Message	Comments
GIA1 CONFIG – GIA1 config error. Config service req’d.	The GIA1 and/or GIA2 configuration settings do not match backup configuration memory. The system should be serviced.
GIA2 CONFIG – GIA2 config error. Config service req’d.	
GIA1 CONFIG – GIA1 audio config error. Config service req’d.	The GIA1 and/or GIA2 have an error in the audio configuration. The system should be serviced.
GIA2 CONFIG – GIA2 audio config error. Config service req’d.	
GIA1 COOLING – GIA1 temperature too low.	The GIA1 and/or GIA2 temperature is too low to operate correctly. Allow units to warm up to operating temperature.
GIA2 COOLING – GIA2 temperature too low.	
GIA1 COOLING – GIA1 over temperature.	The GIA1 and/or GIA2 temperature is too high. If problem persists, the system should be serviced.
GIA2 COOLING – GIA2 over temperature.	
GIA1 SERVICE – GIA1 needs service. Return the unit for repair.	The GIA1 and/or GIA2 self-test has detected a problem in the unit. The system should be serviced.
GIA2 SERVICE – GIA2 needs service. Return the unit for repair.	
HW MISMATCH – GIA hardware mismatch. GIA1 communication halted.	A GIA mismatch has been detected, where only one is SBAS capable.
HW MISMATCH – GIA hardware mismatch. GIA2 communication halted.	

GIA 63W MESSAGE ADVISORIES (CONT.)

Message	Comments
MANIFEST – GIA1 software mismatch, communication halted.	The GIA1 and/or GIA 2 has incorrect software installed. The system should be serviced.
MANIFEST – GIA2 software mismatch, communication halted.	
MANIFEST – GFC software mismatch, communication halted.	Incorrect servo software is installed, or gain settings are incorrect.
MANIFEST – COM1 software mismatch, communication halted.	The COM1 and/or COM2 has incorrect software installed. The system should be serviced.
MANIFEST – COM2 software mismatch, communication halted.	
MANIFEST – NAV1 software mismatch, communication halted.	The NAV1 and/or NAV2 has incorrect software installed. The system should be serviced.
MANIFEST – NAV2 software mismatch, communication halted.	
COM1 TEMP – COM1 over temp. Reducing transmitter power.	The system has detected an over temperature condition in COM1 and/or COM2. The transmitter is operating at reduced power. If the problem persists, the system should be serviced.
COM2 TEMP – COM2 over temp. Reducing transmitter power.	
COM1 SERVICE – COM1 needs service. Return unit for repair.	The system has detected a failure in COM1 and/or COM2. COM1 and/or COM2 may still be usable. The system should be serviced when possible.
COM2 SERVICE – COM2 needs service. Return unit for repair.	
COM1 PTT – COM1 push-to-talk key is stuck.	The COM1 and/or COM2 external push-to-talk switch is stuck in the enable (or “pressed”) position. Press the PTT switch again to cycle its operation. If the problem persists, the system should be serviced.
COM2 PTT – COM2 push-to-talk key is stuck.	
COM1 RMT XFR – COM1 remote transfer key is stuck.	The COM1 and/or COM2 transfer switch is stuck in the enabled (or “pressed”) position. Press the transfer switch again to cycle its operation. If the problem persists, the system should be serviced.
COM2 RMT XFR – COM2 remote transfer key is stuck.	
LOI – GPS integrity lost. Crosscheck with other NAVS.	GPS integrity is insufficient for the current phase of flight.
GPS NAV LOST – Loss of GPS navigation. Insufficient satellites.	Loss of GPS navigation due to insufficient satellites.
GPS NAV LOST – Loss of GPS navigation. Position error.	Loss of GPS navigation due to position error.
GPS NAV LOST – Loss of GPS navigation. GPS fail.	Loss of GPS navigation due to GPS failure.
ABORT APR – Loss of GPS navigation. Abort approach.	Abort approach due to loss of GPS navigation.

SYSTEM OVERVIEW

FLIGHT INSTRUMENTS

EIS

AUDIO PANEL & CNS

FLIGHT MANAGEMENT

HAZARD AVOIDANCE

AFCS

ADDITIONAL FEATURES

APPENDICES

INDEX

GIA 63W MESSAGE ADVISORIES (CONT.)

Message	Comments
APR DWNGRADE – Approach downgraded.	Vertical guidance generated by SBAS is unavailable, use LNAV only minimums.
TRUE APR – True north approach. Change HDG reference to TRUE.	Displayed after passing the first waypoint of a true north approach when the nav angle is set to 'AUTO'.
GPS1 SERVICE – GPS1 needs service. Return unit for repair.	A failure has been detected in the GPS1 and/or GPS2 receiver. The receiver may still be available. The system should be serviced.
GPS2 SERVICE – GPS2 needs service. Return unit for repair.	
NAV1 SERVICE – NAV1 needs service. Return unit for repair.	A failure has been detected in the NAV1 and/or NAV2 receiver. The receiver may still be available. The system should be serviced.
NAV2 SERVICE – NAV2 needs service. Return unit for repair.	
NAV1 RMT XFR – NAV1 remote transfer key is stuck.	The remote NAV1 and/or NAV2 transfer switch is stuck in the enabled (or “pressed”) state. Press the transfer switch again to cycle its operation. If the problem persists, the system should be serviced.
NAV2 RMT XFR – NAV2 remote transfer key is stuck.	
G/S1 FAIL – G/S1 is inoperative.	A failure has been detected in glideslope receiver 1 and/or receiver 2. The system should be serviced.
G/S2 FAIL – G/S2 is inoperative.	
G/S1 SERVICE – G/S1 needs service. Return unit for repair.	A failure has been detected in glideslope receiver 1 and/or receiver 2. The receiver may still be available. The system should be serviced when possible.
G/S2 SERVICE – G/S2 needs service. Return unit for repair.	

GEA 71 MESSAGE ADVISORIES

Message	Comments
GEA1 CONFIG – GEA1 config error. Config service req'd.	The GEA1 configuration settings do not match those of backup configuration memory. The G1000 system should be serviced.
MANIFEST – GEA1 software mismatch, communication halted.	The #1 GEA 71 has incorrect software installed. The G1000 system should be serviced.

GTX 33 MESSAGE ADVISORIES

Message	Comments
XPDR1 CONFIG – XPDR1 config error. Config service req'd.	The transponder configuration settings do not match those of backup configuration memory. The system should be serviced.
MANIFEST – GTX1 software mismatch, communication halted.	The transponder has incorrect software installed. The system should be serviced.
XPDR1 SRVC – XPDR1 needs service. Return unit for repair.	The #1 transponder should be serviced when possible.
XPDR1 FAIL – XPDR1 is inoperative.	There is no communication with the #1 transponder.

GRS 77 MESSAGE ADVISORIES

Message	Comments
AHRS1 TAS – AHRS1 not receiving airspeed.	The #1 AHRS is not receiving true airspeed from the air data computer. The AHRS relies on GPS information to augment the lack of airspeed. The system should be serviced.
AHRS1 GPS – AHRS1 using backup GPS source.	The #1 AHRS is using the backup GPS path. Primary GPS path has failed. The system should be serviced when possible.
AHRS1 GPS – AHRS1 not receiving any GPS information.	The #1 AHRS is not receiving any or any useful GPS information. Check AFMS limitations. The system should be serviced.
AHRS1 GPS – AHRS1 not receiving backup GPS information.	The #1 AHRS is not receiving backup GPS information. The system should be serviced.
AHRS1 GPS – AHRS1 operating exclusively in no-GPS mode.	The #1 AHRS is operating exclusively in no-GPS mode. The system should be serviced.
AHRS1 SRVC – AHRS1 Magnetic-field model needs update.	The #1 AHRS earth magnetic field model is out of date. Update magnetic field model when practical.
GEO LIMITS – AHRS1 too far North/South, no magnetic compass.	The aircraft is outside geographical limits for approved AHRS operation. Heading is flagged as invalid.
MANIFEST – GRS1 software mismatch, communication halted.	The #1 AHRS has incorrect software installed. The system should be serviced.

GMU 44 MESSAGE ADVISORIES

Message	Comments
HDG FAULT – AHRS1 magnetometer fault has occurred.	A fault has occurred in the #1 GMU 44. Heading is flagged as invalid. The AHRS uses GPS for backup mode operation. The G1000 system should be serviced.
MANIFEST – GMU1 software mismatch, communication halted.	The GMU 44 has incorrect software installed. The G1000 system should be serviced.

GDL 69/69A MESSAGE ADVISORIES

Message	Comments
GDL69 CONFIG – GDL 69 config error. Config service req'd.	GDL 69 configuration settings do not match those of backup configuration memory. The G1000 system should be serviced.
GDL69 FAIL – GDL 69 has failed.	A failure has been detected in the GDL 69. The receiver is unavailable. The G1000 system should be serviced.
MANIFEST – GDL software mismatch, communication halted.	The GDL 69 has incorrect software installed. The G1000 system should be serviced.

GDC 74A MESSAGE ADVISORIES

Message	Comments
MANIFEST – GDC1 software mismatch, communication halted.	The GDC 74A has incorrect software installed. The G1000 system should be serviced.

MISCELLANEOUS MESSAGE ADVISORIES

Message	Comments
FPL WPT LOCK – Flight plan waypoint is locked.	Upon power-up, the system detects that a stored flight plan waypoint is locked. This occurs when a navigation database update eliminates an obsolete waypoint. The flight plan cannot find the specified waypoint and flags this message. This can also occur with user waypoints in a flight plan that is deleted. Remove the waypoint from the flight plan if it no longer exists in any database, Or update the waypoint name/identifier to reflect the new information.
FPL WPT MOVE – Flight plan waypoint moved.	The system has detected that a waypoint coordinate has changed due to a new navigation database update. Verify that stored flight plans contain correct waypoint locations.
TIMER EXPIRD – Timer has expired.	The system notifies the pilot that the timer has expired.
DB CHANGE – Database changed. Verify user modified procedures.	This occurs when a stored flight plan contains procedures that have been manually edited. This alert is issued only after a navigation database update. Verify that the user-modified procedures in stored flight plans are correct and up to date.
DB CHANGE – Database changed. Verify stored airways.	This occurs when a stored flight plan contains an airway that is no longer consistent with the navigation database. This alert is issued only after a navigation database update. Verify use of airways in stored flight plans and reload airways as needed.
FPL TRUNC – Flight plan has been truncated.	This occurs when a newly installed navigation database eliminates an obsolete approach or arrival used by a stored flight plan. The obsolete procedure is removed from the flight plan. Update flight plan with current arrival or approach.
LOCKED FPL – Cannot navigate locked flight plan.	This occurs when the pilot attempts to activate a stored flight plan that contains locked waypoint. Remove locked waypoint from flight plan. Update flight plan with current waypoint.
WPT ARRIVAL – Arriving at waypoint -[xxxx]	Arriving at waypoint [xxxx], where [xxxx] is the waypoint name.
STEEP TURN – Steep turn ahead.	A steep turn is 15 seconds ahead. Prepare to turn.
INSIDE ARSPC – Inside airspace.	The aircraft is inside the airspace.
ARSPC AHEAD – Airspace ahead less than 10 minutes.	Special use airspace is ahead of aircraft. The aircraft will penetrate the airspace within 10 minutes.
ARSPC NEAR – Airspace near and ahead.	Special use airspace is near and ahead of the aircraft position.
ARSPC NEAR – Airspace near – less than 2 nm.	Special use airspace is within 2 nm of the aircraft position.
APR INACTV – Approach is not active.	The system notifies the pilot that the loaded approach is not active. Activate approach when required.
SLCT FREQ – Select appropriate frequency for approach.	The system notifies the pilot to load the approach frequency for the appropriate NAV receiver. Select the correct frequency for the approach.
SLCT NAV – Select NAV on CDI for approach.	The system notifies the pilot to set the CDI to the correct NAV receiver. Set the CDI to the correct NAV receiver.
PTK FAIL – Parallel track unavailable: bad geometry.	Bad parallel track geometry.

MISCELLANEOUS MESSAGE ADVISORIES (CONT.)

Message	Comments
PTK FAIL – Parallel track unavailable: past IAF.	IAF waypoint for parallel offset has been passed.
PTK FAIL – Parallel track unavailable: past IAF.	IAF waypoint for parallel offset has been passed.
NON WGS84 WPT – Do not use GPS for navigation to [xxxx]	The position of the selected waypoint [xxxx] is not calculated based on the WGS84 map reference datum and may be positioned in error as displayed. Do not use GPS to navigate to the selected non-WGS84 waypoint.
STRMSCP FAIL – Stormscope has failed.	Stormscope has failed. The G1000 system should be serviced.
UNABLE V WPT – Can't reach current vertical waypoint.	The current vertical waypoint can not be reached within the maximum flight path angle and vertical speed constraints. The system automatically transitions to the next vertical waypoint.
VNV – Unavailable. Excessive track angle error.	The current track angle error exceeds the limit, causing the vertical deviation to go invalid.
VNV – Unavailable. Unsupported leg type in flight plan.	The lateral flight plan contains a procedure turn, vector, or other unsupported leg type prior to the active vertical waypoint. This prevents vertical guidance to the active vertical waypoint.
VNV – Unavailable. Excessive crosstrack error.	The current crosstrack exceeds the limit, causing vertical deviation to go invalid.
VNV – Unavailable. Parallel course selected.	A parallel course has been selected, causing the vertical deviation to go invalid.
TRAFFIC FAIL – Traffic device has failed.	The system is no longer receiving data from the traffic system. The traffic device should be serviced.
FAILED PATH – A data path has failed.	A data path connected to the GDU, GSD 41, or the GIA 63/W has failed.
MAG VAR WARN – Large magnetic variance. Verify all course angles.	The GDU's internal model cannot determine the exact magnetic variance for geographic locations near the magnetic poles. Displayed magnetic course angles may differ from the actual magnetic heading by more than 2°.
SVS – SVS DISABLED: Out of available terrain region.	Synthetic Vision is disabled because the aircraft is not within the boundaries of the installed terrain database.
SVS – SVS DISABLED: Terrain DB resolution too low.	Synthetic Vision is disabled because a terrain database of sufficient resolution (9 arc-second or better) is not currently installed.
SCHEDULER [#] – <message>.	Message criteria entered by the user.
CHECK CRS – Database course for LOC1 / [LOC ID] is [CRS]°.	Selected course for LOC1 differs from published localizer course by more than 10 degrees.
CHECK CRS – Database course for LOC2 / [LOC ID] is [CRS]°.	Selected course for LOC2 differs from published localizer course by more than 10 degrees.
[PFD1 or MFD1] CARD 1 REM – Card 1 was removed. Reinsert card.	The SD card was removed from the top card slot of the PFD or MFD. The SD card needs to be reinserted.
[PFD1 or MFD1] CARD 2 REM – Card 2 was removed. Reinsert card.	The SD card was removed from the bottom card slot of the PFD or MFD. The SD card needs to be reinserted.

MISCELLANEOUS MESSAGE ADVISORIES (CONT.)

Message	Comments
[PFD1 or MFD1] CARD 1 ERR – Card 1 is invalid.	The SD card in the top card slot of the PFD or MFD contains invalid data.
[PFD1 or MFD1] CARD 2 ERR – Card 2 is invalid.	The SD card in the bottom card slot of the PFD or MFD contains invalid data.
TRN AUD FAIL – Trn Awareness audio source unavailable.	The audio source for terrain awareness is offline. Check GIA1 or GIA 2.
TERRAIN AUD CFG – Trn Awareness audio config error. Service req'd.	Terrain audio alerts are not configured properly. The system should be serviced

FLIGHT PLAN IMPORT/EXPORT MESSAGES

In some circumstances, some messages may appear in conjunction with others.

Flight Plan Import/Export Results	Description
'Flight plan successfully imported.'	A flight plan file stored on the SD card was successfully imported as a stored flight plan.
'File contained user waypoints only. User waypoints imported successfully. No stored flight plan data was modified.'	The file stored on the SD card did not contain a flight plan, only user waypoints. These waypoints have been saved to the system user waypoints. No flight plans stored in the system have been modified.
'No flight plan files found to import.'	The SD card contains no flight plan data.
'Flight plan import failed.'	Flight plan data was not successfully imported from the SD card.
'Flight plan partially imported.'	Some flight plan waypoints were successfully imported from the SD card, however others had errors and were not imported. A partial stored flight plan now exists in the system.
'File contained user waypoints only.'	The file stored on the SD card did not contain a flight plan, only user waypoints. One or more of these waypoints did not import successfully.
'Too many points. Flight plan truncated.'	The flight plan on the SD card contains more waypoints than the system can support. The flight plan was imported with as many waypoints as possible.
'Some waypoints not loaded. Waypoints locked.'	The flight plan on the SD card contains one or more waypoints that the system cannot find in the navigation database. The flight plan has been imported, but must be edited within the system before it can be activated for use.
'User waypoint database full. Not all loaded.'	The flight plan file on the SD card contains user waypoints. The quantity of stored user waypoints has exceeded system capacity, therefore not all the user waypoints on the SD card have been imported. Any flight plan user waypoints that were not imported are locked in the flight plan. The flight plan must be edited within the system before it can be activated for use.
'One or more user waypoints renamed.'	One or more imported user waypoints were renamed when imported due to naming conflicts with waypoints already existing in the system.
'Flight plan successfully exported.'	The stored flight plan was successfully exported to the SD card.
'Flight plan export failed.'	The stored flight plan was not successfully exported to the SD card. The SD card may not have sufficient available memory or the card may have been removed prematurely.

AFCS ALERTS

System Status Field



Figure A-6 AFCS System Status Field

The following alert annunciations appear in the AFCS System Status field on the PFD.

Condition	Annunciation	Description
Pitch Failure	PTCH	Pitch axis control failure. AP is inoperative.
Roll Failure	ROLL	Roll axis control failure. AP is inoperative.
MET Switch Stuck, or Pitch Trim Axis Control Failure	PTRM	If annunciated when AP is engaged, take control of the aircraft and disengage the autopilot. If annunciated when AP is not engaged, move each half of the MET switch separately to check if a stuck switch is causing the annunciation.
System Failure	AFCS	AP and MET are unavailable. FD may still be available.
Elevator Mistrim Up	↑ELE	A condition has developed causing the pitch servo to provide a sustained force. Be prepared to apply nose up control wheel force upon autopilot disconnect.
Elevator Mistrim Down	↓ELE	A condition has developed causing the pitch servo to provide a sustained force. Be prepared to apply nose down control wheel force upon autopilot disconnect.
Aileron Mistrim Left	←AIL	A condition has developed causing the roll servo to provide a sustained left force. Ensure the slip/skid indicator is centered and observe any maximum fuel imbalance limits.
Aileron Mistrim Right	AIL→	A condition has developed causing the roll servo to provide a sustained right force. Ensure the slip/skid indicator is centered and observe any maximum fuel imbalance limits.
Preflight Test	PFT	Performing preflight system test. Upon completion of the test, the aural alert is heard.
	PFT	Preflight system test has failed.

NOTE: Do not press the AP DISC switch during servo power-up and preflight system tests as this may cause the preflight system test to fail or never to start (if servos fail their power-up tests). Power must be cycled to the servos to remedy the situation.

TERRAIN-SVS ALERTS

Alert Type	PFD/MFD TERRAIN-SVS Page Annunciation	MFD Pop-Up Alert	Aural Message
Reduced Required Terrain Clearance Warning (RTC)	TERRAIN	WARNING - TERRAIN	"Warning; Terrain, Terrain"
Imminent Terrain Impact Warning (ITI)	TERRAIN	WARNING - TERRAIN	"Warning; Terrain, Terrain"
Reduced Required Obstacle Clearance Warning (ROC)	TERRAIN	WARNING - OBSTACLE	"Warning; Obstacle, Obstacle"
Imminent Obstacle Impact Warning (IOI)	TERRAIN	WARNING - OBSTACLE	"Warning; Obstacle, Obstacle"
Reduced Required Terrain Clearance Caution (RTC)	TERRAIN	CAUTION - TERRAIN	"Caution; Terrain, Terrain"
Imminent Terrain Impact Caution (ITI)	TERRAIN	CAUTION - TERRAIN	"Caution; Terrain, Terrain"
Reduced Required Obstacle Clearance Caution (ROC)	TERRAIN	CAUTION - OBSTACLE	"Caution; Obstacle, Obstacle"
Imminent Obstacle Impact Caution (IOI)	TERRAIN	CAUTION - OBSTACLE	"Caution; Obstacle, Obstacle"

TERRAIN-SVS SYSTEM STATUS ANNUNCIATIONS

Alert Type	PFD/MFD Alert Annunciation	TERRAIN-SVS Page Annunciation	Aural Message
System Test in Progress	TER TEST	TERRAIN TEST	None
System Test Pass	None	None	"Terrain System Test OK"
Terrain Alerting is disabled	TER INH	None	None
MFD Terrain or Obstacle database unavailable or invalid. Terrain-SVS operating with PFD Terrain or Obstacle databases	None	TERRAIN DATABASE FAILURE	None
Terrain System Test Fail	TER FAIL	TERRAIN FAIL	"Terrain System Failure"
Terrain or Obstacle database unavailable or invalid, invalid software configuration, system audio fault	TER FAIL	TERRAIN FAIL	"Terrain System Failure"
No GPS position	TER N/A	NO GPS POSITION	"Terrain System Not Available"
Excessively degraded GPS signal, Out of database coverage area	TER N/A	None	"Terrain System Not Available"
Sufficient GPS signal received after loss	None	None	"Terrain System Available"

SYSTEM OVERVIEW

FLIGHT INSTRUMENTS

EIS

AUDIO PANEL & CNS

FLIGHT MANAGEMENT

HAZARD AVOIDANCE

AFCS

ADDITIONAL FEATURES

APPENDICES

INDEX

TAWS-B ALERTS

Annunciations appear on the PFD and MFD. Pop-up alerts appear only on the MFD.

Alert Type	PFD/MFD TAWS Page Annunciation	MFD Map Page Pop-Up Alert	Aural Message
Excessive Descent Rate Warning (EDR)	PULL UP	PULL-UP	"Pull Up"
Reduced Required Terrain Clearance Warning (RTC)	PULL UP	TERRAIN - PULL-UP or TERRAIN AHEAD - PULL-UP	"Terrain, Terrain; Pull Up, Pull Up" or "Terrain Ahead, Pull Up; Terrain Ahead, Pull Up"
Imminent Terrain Impact Warning (ITI)	PULL UP	TERRAIN AHEAD - PULL-UP or TERRAIN - PULL-UP	Terrain Ahead, Pull Up; Terrain Ahead, Pull Up" or "Terrain, Terrain; Pull Up, Pull Up"
Reduced Required Obstacle Clearance Warning (ROC)	PULL UP	OBSTACLE - PULL-UP or OBSTACLE AHEAD - PULL-UP	"Obstacle, Obstacle; Pull Up, Pull Up" or "Obstacle Ahead, Pull Up; Obstacle Ahead, Pull Up"
Imminent Obstacle Impact Warning (IOI)	PULL UP	OBSTACLE AHEAD - PULL-UP or OBSTACLE - PULL-UP	"Obstacle Ahead, Pull Up; Obstacle Ahead, Pull Up" or "Obstacle, Obstacle; Pull Up, Pull Up"
Reduced Required Terrain Clearance Caution (RTC)	TERRAIN	CAUTION - TERRAIN or TERRAIN AHEAD	"Caution, Terrain; Caution, Terrain" or "Terrain Ahead; Terrain Ahead"
Imminent Terrain Impact Caution (ITI)	TERRAIN	TERRAIN AHEAD or CAUTION - TERRAIN	"Terrain Ahead; Terrain Ahead" or "Caution, Terrain; Caution, Terrain"
Reduced Required Obstacle Clearance Caution (ROC)	TERRAIN	CAUTION - OBSTACLE or OBSTACLE AHEAD	"Caution, Obstacle; Caution, Obstacle" or "Obstacle Ahead; Obstacle Ahead"
Imminent Obstacle Impact Caution (IOI)	TERRAIN	OBSTACLE AHEAD or CAUTION - OBSTACLE	"Obstacle Ahead; Obstacle Ahead" or "Caution, Obstacle; Caution, Obstacle"
Premature Descent Alert Caution (PDA)	TERRAIN	TOO LOW - TERRAIN	"Too Low, Terrain"
Altitude Callout "500"	None	None	"Five-Hundred"
Excessive Descent Rate Caution (EDR)	TERRAIN	SINK RATE	"Sink Rate"
Negative Climb Rate Caution (NCR)	TERRAIN	DON'T SINK or TOO LOW - TERRAIN	"Don't Sink" or "Too Low, Terrain"

TAWS-B SYSTEM STATUS ANNUNCIATIONS

Alert Type	PFD/MFD Alert Annunciation	TAWS-B Page Annunciation	Aural Message
System Test in Progress	TAWS TEST	TAWS TEST	None
System Test Pass	None	None	"TAWS System Test OK"
TAWS Alerting is disabled	TAWS INH	None	None
MFD Terrain or Obstacle database unavailable or invalid. TAWS operating with PFD Terrain or Obstacle databases	None	TERRAIN DATABASE FAILURE	None
TAWS-B System Test Fail	TAWS FAIL	TAWS FAIL	"TAWS System Failure"
Terrain or Obstacle database unavailable or invalid, invalid software configuration, system audio fault	TAWS FAIL	TAWS FAIL	"TAWS System Failure"
No GPS position	TAWS N/A	NO GPS POSITION	"TAWS Not Available"
Excessively degraded GPS signal, Out of database coverage area	TAWS N/A	None	"TAWS Not Available"
Sufficient GPS signal received after loss	None	None	"TAWS Available"

SYSTEM
OVERVIEW

FLIGHT
INSTRUMENTS

EIS

AUDIO PANEL
& CNS

FLIGHT
MANAGEMENT

HAZARD
AVOIDANCE

AFCS

ADDITIONAL
FEATURES

APPENDICES

INDEX

BLANK PAGE

DATABASE MANAGEMENT



CAUTION: Never disconnect power to the system when loading a database. Power interruption during the database loading process could result in maintenance being required to reboot the system.

The system uses Secure Digital (SD) cards to load and store various types of data. For basic flight operations, SD cards are required for database storage as well as Jeppesen navigation and ChartView database updates. Not all SD cards are compatible with the G1000. Use only SD cards supplied by Garmin or the aircraft manufacturer.



CAUTION: When downloading updates to the Jeppesen Navigation Database, copy the data to an SD card other than a Garmin Supplemental Data Card. Otherwise, data corruption can occur.



NOTE: When loading database updates, the 'DB Mismatch' message will be displayed until database synchronization is complete, followed by turning system power off, then on. Synchronization can be monitored on the AUX-SYSTEM STATUS Page.



NOTE: Loading a database in the system prior to its effective date will result in the expiration date on the power-up screen and the effective date on the AUX-System Status Page being displayed in yellow.



NOTE: Garmin requests the flight crew report any observed discrepancies related to database information. These discrepancies could come in the form of an incorrect procedure; incorrectly identified terrain, obstacles and fixes; or any other displayed item used for navigation or communication in the air or on the ground. Go to FlyGarmin.com and select "Aviation Data Error Report."

JEPPESEN DATABASES

The Jeppesen navigation database is updated on a 28-day cycle. The ChartView database is updated on a 14-day cycle. If the ChartView database is not updated within 70 days of the expiration date, ChartView will no longer function. Both of these databases are provided directly from Jeppesen.



NOTE: The Jeppesen aviation navigation database is now referred to as the 'navigation database'. Previously this database had been referred to as the 'aviation database'.

The ChartView database should be copied to the Garmin supplied Supplemental Data Card which will reside in the bottom card slot on the MFD. The navigation database must be installed from the Jeppesen or user supplied SD data card. Contact Jeppesen (www.jeppesen.com) for subscription and update information.



NOTE: After the navigation database is installed, the card may be removed.

Updating the active Jeppesen navigation database (not using the Dual Navigation Database or Automatic Database Synchronization Features):

- 1) With the system OFF, insert the SD card containing the new navigation database version into the top card slot of the display (PFD or MFD) to be updated (label of SD card facing left).
- 2) Turn the system ON. A prompt similar to the following is displayed in the upper left corner of the display:

```
DO YOU WANT TO UPDATE THE STANDBY NAVIGATION DATABASE ON THE BOTTOM CARD?
THE STANDBY DATABASE WILL BE ACTIVATED UPON THE FIRST ON-GROUND POWER CYCLE ON OR
AFTER 00:00 SYSTEM TIME ON THE EFFECTIVE DATE.
      FROM           TO
REGION:  WORLDWIDE   WORLDWIDE
CYCLE:   0904        0905
EFFECTIVE: 09-APR-2009 07-MAY-2009
EXPIRES:  07-MAY-2009 04-JUN-2009

NO WILL BE ASSUMED IN 21 SECONDS.
```

Figure B-1 Standby Navigation Database Prompt

- 3) Press the **NO** Softkey to proceed to loading the active database.
- 4) A prompt similar to the following is displayed, press the **YES** Softkey to update the active navigation database.

```
DO YOU WANT TO UPDATE THE ACTIVE NAVIGATION DATABASE?
SELECTING YES WILL OVERWRITE THE ACTIVE NAVIGATION DATABASE.
      FROM           TO
REGION:  WORLDWIDE   WORLDWIDE
CYCLE:   0904        0905
EFFECTIVE: 09-APR-2009 07-MAY-2009
EXPIRES:  07-MAY-2009 04-JUN-2009

NO WILL BE ASSUMED IN 8 SECONDS.
UPDATING THE ACTIVE NAVIGATION DATABASE, PLEASE WAIT.
.
UPDATED 1 FILES SUCCESSFULLY!
PRESS ANY KEY TO CONTINUE.
CONTINUING IN 8 SECONDS.
```

Figure B-2 Database Update Confirmation

- 5) After the update completes, the display starts in normal mode. Do not remove power while the display is starting.
- 6) Turn the system OFF and remove the SD card from the top card slot.
- 7) Repeat steps 1 through 6 for the other display (PFD or MFD). Remove the SD card when finished.
- 8) Apply power to the system and press the **ENT** Key to acknowledge the startup screen.
- 9) Turn the large **FMS** Knob to select the AUX Page group on the MFD.
- 10) Turn the small **FMS** Knob to select the System Status Page.
- 11) Press the Display Database Selection Softkey to show active navigation database information for each display (**MFD1 DB** or **PFD1 DB**). Verify the correct active navigation database cycle information is shown for each display.

DUAL NAVIGATION DATABASE FEATURE

The dual navigation database feature allows each display to store an upcoming navigation database on the bottom SD card so that the system can automatically load it to replace the active database when the new database becomes effective (the next cycle becomes available seven days prior to its effective date).

If a navigation database loader card is inserted into the top SD card slot of a display, and an SD card is in the bottom slot, the system will prompt the user (upon on-ground power up) as to whether the database should be stored on the bottom SD card as the standby database. If the user responds affirmatively, the system will copy the navigation database from the top SD card to the bottom SD card. As long as the bottom SD card remains in the card slot, this standby navigation database will be available for the system to use as the active database as soon as it becomes effective.

The system checks the active and standby databases upon (on-ground only) power-up. If the standby database is current and the active database is out of date, the display will upload the standby database into the active internal database location. Uploading the standby database to the active location takes approximately 45-55 seconds. The pilot is alerted that the update is complete by a system alert message, 'NAV DB UPDATED'.

Loading a standby navigation database:

- 1) With the system OFF, insert the SD card containing the new navigation database version into the top card slot of the MFD.
- 2) Verify that an SD card is inserted in the bottom slot of the PFD and the MFD.
- 3) Turn the system ON. A prompt similar to the following is displayed.

```
DO YOU WANT TO UPDATE THE STANDBY NAVIGATION DATABASE ON THE BOTTOM CARD?
THE STANDBY DATABASE WILL BE ACTIVATED UPON THE FIRST ON-GROUND POWER CYCLE ON OR
AFTER 00:00 SYSTEM TIME ON THE EFFECTIVE DATE.
FROM TO
REGION: WORLDWIDE WORLDWIDE
CYCLE: 0904 0905
EFFECTIVE: 09-APR-2009 07-MAY-2009
EXPIRES: 07-MAY-2009 04-JUN-2009
NO WILL BE ASSUMED IN 21 SECONDS.
```

Figure B-3 Standby Navigation Database Prompt

- 4) Press the **YES** Softkey. The navigation database is copied to the SD card in the bottom card slot of the MFD.
- 5) After the navigation database files are copied to the bottom SD card, the display will appear as shown in Figure B-4.

```

INITIALIZING SYSTEM

DO YOU WANT TO UPDATE THE STANDBY NAVIGATION DATABASE ON THE BOTTOM CARD?
THE STANDBY DATABASE WILL BE ACTIVATED UPON THE FIRST ON-GROUND POWER CYCLE ON OR
AFTER 00:00 SYSTEM TIME ON THE EFFECTIVE DATE.

REGION:    FROM          TO
           WORLDWIDE    WORLDWIDE
CYCLE:     1009           1012
EFFECTIVE: 26-AUG-2010      18-NOV-2010
EXPIRES:   23-SEP-2010  16-DEC-2010

NO WILL BE ASSUMED IN 18 SECONDS.
UPDATING STANDBY NAVIGATION DATABASE, PLEASE WAIT.
.
UPDATED STANDBY NAVIGATION DATABASE SUCCESSFULLY.
PRESS ANY KEY TO CONTINUE.
CONTINUING IN 9 SECONDS.

```

Figure B-4 Standby Navigation Database Update Complete

- 6) As instructed on the display, press any key to continue. The display will now appear as shown in Figure B-5.

```

DATABASE NAVIGATION WILL BE VERIFIED BEFORE USE.
DATABASE STANDBY NAV WILL BE VERIFIED BEFORE USE.
PRESS ANY KEY TO CONTINUE.
CONTINUING IN 6 SECONDS.

```

Figure B-5 Navigation Database Verification Prompt

- 7) Press any key to continue. The display will now appear as shown in Figure B-6.

```

.
DO YOU WANT TO UPDATE THE ACTIVE NAVIGATION DATABASE?
SELECTING YES WILL OVERWRITE THE ACTIVE NAVIGATION DATABASE.

REGION:    FROM          TO
           WORLDWIDE    WORLDWIDE
CYCLE:     0904           0905
EFFECTIVE: 09-APR-2009    07-MAY-2009
EXPIRES:   07-MAY-2009    04-JUN-2009

NO WILL BE ASSUMED IN 8 SECONDS.

```

Figure B-6 Active Navigation Database Prompt

- 8) Press the **NO** Softkey. The display now starts in normal mode. Since the database effective date is not yet valid, it should not be loaded as the active database. The display now starts in normal mode. Do not remove power while the display is starting.
- 9) Press the **ENT** Key to acknowledge the startup screen.
- 10) Turn the large **FMS** Knob to select the AUX Page group on the MFD.
- 11) Turn the small **FMS** Knob to select the System Status Page.
- 12) The new database is copied to the SD card in the bottom card slot of the PFD. Progress can be monitored in the SYNC STATUS field. When copying is finished, 'Complete' is displayed.
- 13) Turn system power OFF.

- 14) Remove the SD card from the top card slot of the MFD.
- 15) Turn system power ON.
- 16) Press the **ENT** Key to acknowledge the startup screen.
- 17) Turn the large **FMS** Knob to select the AUX Page group on the MFD.
- 18) Turn the small **FMS** Knob to select the System Status Page.
- 19) Press the Display Database Selection Softkey to show standby navigation database information for each display (**MFD1 DB** or **PFD1 DB**). Verify the correct standby navigation database cycle information is shown for each display.

GARMIN DATABASES

The following databases are stored on Supplemental Data Cards provided by Garmin:

- Expanded basemap
- Terrain
- Airport terrain
- Obstacle
- SafeTaxi
- FliteCharts
- Airport Directory (AOPA)

After subscribing to the desired database product, these database products will be downloaded and ultimately stored on two Supplemental Data Cards (with the exception of FliteCharts, which is loaded on only one card). Each Supplemental Data Card resides in the bottom card of each display as shown in Figure B-7. These cards must not be removed except to update the databases stored on each card.

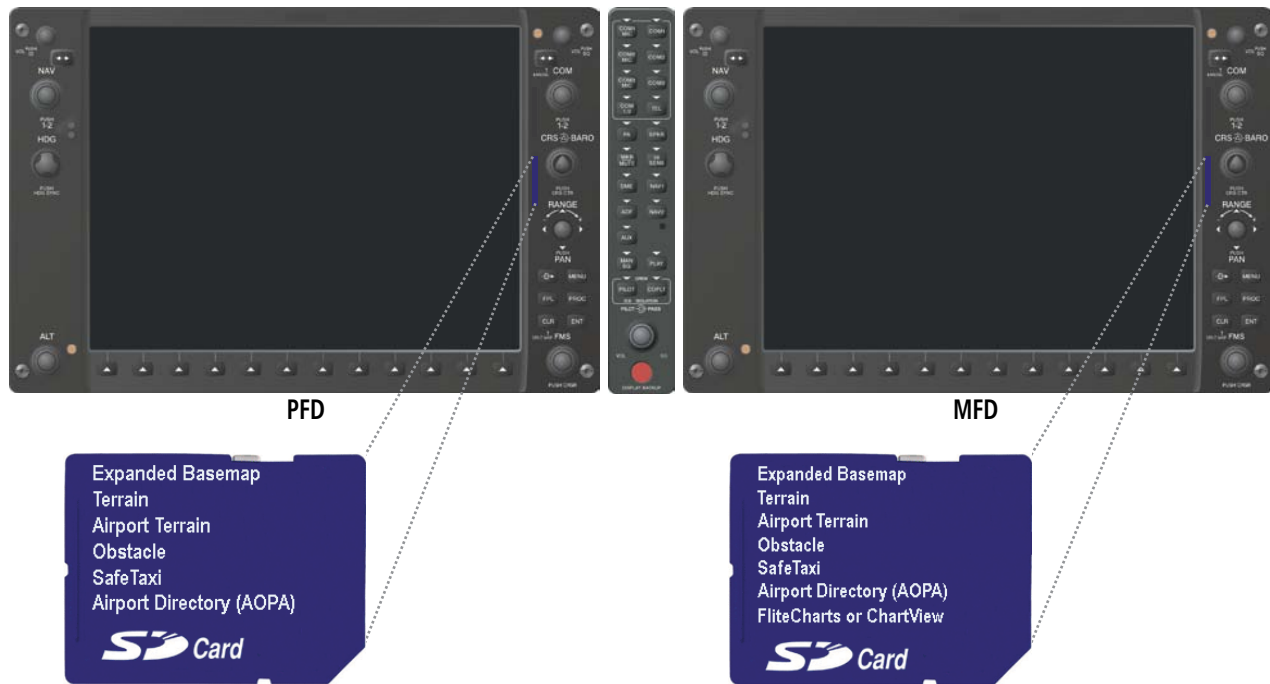

Figure B-3 Correct Database Locations

Since these databases are not stored internally in the displays, a Supplemental Data Card containing identical database versions must be kept in each display unit.

The basemap database contains data for the topography and land features, such as rivers, lakes, and towns. It is updated only periodically, with no set schedule. There is no expiration date.

The terrain database contains the terrain mapping data. The airport terrain database contains increased resolution terrain data around airports. These databases are updated periodically and have no expiration date.

The obstacle database contains data for obstacles, such as towers, that pose a potential hazard to aircraft. Obstacles 200 feet and higher are included in the obstacle database. It is very important to note that not all obstacles are necessarily charted and therefore may not be contained in the obstacle database. This database is updated on a 56-day cycle.



NOTE: *The data contained in the terrain and obstacle databases comes from government agencies. Garmin accurately processes and cross-validates the data, but cannot guarantee the accuracy and completeness of the data.*

The AOPA Airport Directory provides data on airports and heliports throughout the U.S., and offers detailed information for over 5,300 U. S. airports, along with the names and phone numbers of thousands of FBOs. This database is updated four times per year.

The SafeTaxi database contains detailed airport diagrams for selected airports. These diagrams aid in following ground control instructions by accurately displaying the aircraft position on the map in relation to taxiways, ramps, runways, terminals, and services. This database is updated on a 56-day cycle.

The FliteCharts database contains procedure charts for the United States only. This database is updated on a 28-day cycle. If not updated within 180 days of the expiration date, FliteCharts will no longer function.

AUTOMATIC DATABASE SYNCHRONIZATION FEATURE

The automatic database synchronization feature automatically transfers the database from a single SD database card to the SD cards on the PFD and the MFD to ensure that all databases are synchronized throughout the system. After power-up, the system compares all copies of each applicable database. If similar databases do not match, the most recent valid database is automatically copied to each card in the system that does not already contain that database.

The following databases are checked and synchronized: Basemap, Safetaxi, Airport Terrain, Obstacle, Airport Directory (AOPA), and Terrain. This feature applies only to databases that are stored on the SD card that resides in the bottom slot of each display. This feature does not apply to the navigation database which is stored internally in each display, or to the charts databases (FliteCharts and ChartView) which are only required to be present on the MFD. The typical procedure would be to download new databases to the MFD card, then synchronize the data to the PFD(s).



NOTE: The 9-arc second terrain database may take as long as 100 minutes to synchronize using this method. Therefore the user may want to transfer the data using a PC, or connect the system to a ground power source while performing the database synchronization.

The synchronization progress may be monitored on the AUX-System Status Page in the Sync Status section of the Database Window (Figure B-8). This section shows the synchronization status of each applicable database, including the percent complete, time remaining, and to which displays the databases are being copied. When the synchronization is complete, the status is listed as 'Complete', followed by the displays to which the databases were copied. This sub-section is only present when a sync is occurring or has occurred on the current power-up.

An indication of 'Complete' still requires a power cycle before the synchronized databases will be used by the system.



Figure B-8 AUX-System Status Page, Database Window

The Display Database Softkey (Figure B-11) is used to place the cursor in the Database Window. Upon first press of the Display Database Softkey, the softkey will change to a selected state (black text on gray background) and the cursor will appear in the Database Window. At this point the user can scroll through all databases in the Database Window to view status information. If the Display Database Softkey is pressed repeatedly, the softkey will switch between PFD1 and MFD1. Database status information in the Database Window will reflect the database of the selected display. After a successful sync and restart, verify that the proper databases are now in use on the AUX-System Status Page (Figure B-8).

If an error occurs during the synchronization, an error message will be displayed, followed by the affected display in the Sync Status section of the Database Window (Figure B-9). If a synchronization completes on one display, but an error occurs on the other, the error message will be displayed with the affected display listed after it. When an error message (Table B-1) is displayed, the problem must be corrected before the synchronization can be completed. A power cycle is required to restart synchronization when 'Card Full' or 'Err' is shown.



Database Synchronization Error Message
 Figure B-9 Synchronization Error Message

Error Message	Description
Canceled	Database synchronization has been canceled by removing the bottom SD card in display being updated
Card Full	SD card does not contain sufficient memory
Err	Displayed for all other errors that may cause the synchronization process to be halted
Timeout	System timed-out prior to the database transfer completing

Table B-1 Database Synchronization Error Messages

UPDATING GARMIN DATABASES

The Garmin database updates can be obtained by following the instructions detailed in the 'Aviation Databases' section of the Garmin website (fly.garmin.com). Once the updated files have been downloaded from the website, a PC equipped with an appropriate SD card reader is used to unpack and program the new databases onto an existing Supplemental Data Card. Equipment required to perform the update is as follows:

- Windows-compatible PC computer (running Windows XP, Vista, or Windows 7)
- SD Card Reader: SanDisk SDDR-93, SanDisk SDDR-99, Verbatim #96504, or equivalent
- Updated database obtained from the Garmin website
- Existing Supplemental Database SD Cards (010-00330-42, or -43) from the PFD and MFD

In some cases it may be necessary to obtain an unlock code from Garmin in order to make the database product functional. It may also be necessary to have the system configured by a Garmin authorized service facility in order to use some database features.

After the data has been copied to the appropriate data card, perform the following steps:

- 1) With system power OFF, remove the MFD database card from the bottom card slot of the MFD.
- 2) Update the Garmin databases on the MFD card.
- 3) Insert the MFD database card into the bottom card slot of the MFD.
- 4) Apply power to the system, check that the databases are initialized and displayed on the power-up screen (Figure B-10). When updating the terrain and FliteCharts databases, a 'Verifying' message may be seen. If this message is present, wait for the system to finish loading before proceeding to step 5.



Figure B-10 Database Information on the Power-up Screen

- 5) Acknowledge the Power-up Page agreement by pressing the **ENT** Key or the right most softkey.
- 6) Turn the large **FMS** Knob to select the AUX Page group on the MFD.
- 7) Turn the small **FMS** Knob to select the System Status Page.
- 8) Monitor the Sync Status in the Database Window. Wait for all databases to complete syncing, indicated by 'Complete' being displayed as seen in Figure B-9.
- 9) Remove and reapply power to the system.
- 10) Turn the large **FMS** Knob to select the AUX Page group on the MFD.
- 11) Turn the small **FMS** Knob to select the System Status Page.
- 12) Press the Display Database Selection Softkey to show database information for each display (**MFD1 DB** or **PFD1 DB**). Verify the correct database cycle information is shown for each database for each display.



Figure B-11 Display Database Softkey

MAGNETIC FIELD VARIATION DATABASE UPDATE

A copy of the current magnetic field variation database (MV DB) is included with the navigation database. At startup, the system compares this version of the MV DB with that presently being used by the AHRS (GRS). If the system determines the MV DB needs to be updated, a prompt is displayed on the Navigation Map Page.

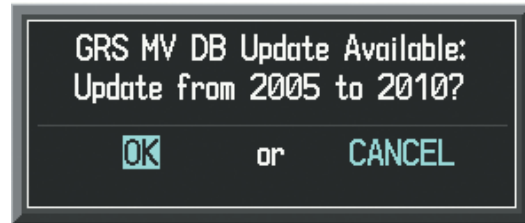

Figure B-12 GRS Magnetic Field Variation Database Update Prompt

Loading the magnetic field variation database update:

- 1) With 'OK' highlighted, as shown in figure B-12, press the **ENT** Key on the MFD. A progress monitor is displayed as shown in Figure B-13.



Figure B-13 Uploading Database to GRS

- 2) When the upload is complete, the system is ready for use.

GLOSSARY

ACC	accuracy	C	center runway
ACT, ACTV	active, activate	°C	degrees Celsius
ADC	air data computer	CA	Course to Altitude
ADF	Automatic Direction Finder	CALC	calculator
ADI	Attitude Direction Indicator	Calibrated Airspeed	Indicated airspeed corrected for installation and instrument errors.
AF	Arc to fix	CD	Course to DME distance
AFCS	Automatic Flight Control System	CDI	Course Deviation Indicator
AFM	Airplane Flight Manual	CDU	Control Display Unit
AFMS	Airplane Flight Manual Supplement	CF	Course to Fix
AFRM	airframe	CHT	Cylinder Head Temperature
AGL	Above Ground Level	CHKLIST	checklist
AHRS	Attitude and Heading Reference System	CHNL	channel
AIM	Aeronautical Information Manual	CI	Course to Intercept
AIRMET	Airman's Meteorological Information	CLD	cloud
ALRT	alert	CLR	clear
ALT	altitude	cm	centimeter
ALT, ALTN	alternator	CNS	Communication, Navigation, & Surveillance
AMPS	amperes	CO	carbon monoxide
ANNUNC	annunciation	COM	communication radio
ANT	antenna	CONFIG	configuration
AOPA	Aircraft Owners & Pilots Association	COOL	coolant
AP	autopilot	COPLT	co-pilot
AP DISC	autopilot disconnect	Course	The line between two points to be followed by the aircraft.
APR	approach	Course to Steer	The recommended direction to steer in order to reduce course error or stay on course. Provides the most efficient heading to get back to the desired course and proceed along the flight plan.
APT	airport, aerodrome		
ARINC	Aeronautical Radio Incorporated		
ARSPC	airspace	CR	Course to Radial
ARTCC	Air Route Traffic Control Center	CRG	Cockpit Reference Guide
ARV	arrival	CRNT	current
AS	airspeed	Crosstrack Error	The distance the aircraft is off a desired course in either direction, left or right.
ASB	Aviation Support Branch	CRS	course
ASOS	Automated Surface Observing System	CRS	Course to Steer
ATC	Air Traffic Control	CRSR	cursor
ATCRBS	ATC Radar Beacon System	CTA	Control Area
ATIS	Automatic Terminal Information Service	CTRL	control
ATK	along-track	Cumulative	The total of all legs in a flight plan.
AUTOSEQ	automatic sequence	CVR	Cockpit Voice Recorder
AUX	auxiliary	CVRG	coverage
AWOS	Automated Weather Observing System	CWS	control wheel steering
		CYL	cylinder
B ALT	barometric altitude		
BARO	barometric setting	D ALT	density altitude
BATT	battery	DB, DBASE	database
BC	backcourse	dBZ	decibels 'Z' (radar return)
Bearing	The compass direction from the present position to a destination waypoint.		
BFO	beat frequency oscillator		
BKSP	backspace		
BRG	bearing		

SYSTEM OVERVIEW

FLIGHT INSTRUMENTS

EIS

AUDIO PANEL & CNS

FLIGHT MANAGEMENT

HAZARD AVOIDANCE

AFCS

ADDITIONAL FEATURES

APPENDICES

INDEX

DCLTR, DECLTR	declutter	EPE	Estimated Position Error
DEC FUEL	decrease fuel	EPU	Estimated Position Uncertainty
deg	degree	ERR	error
DEIC, DEICE	de-icing	ESA	Enroute Safe Altitude
DEP	departure	Estimated Position Error	A measure of horizontal GPS position error derived by satellite geometry conditions and other factors.
Desired Track	The desired course between the active "from" and "to" waypoints.	Estimated Time of Arrival	The estimated time at which the aircraft should reach the destination waypoint, based upon current speed and track.
DEST	destination	Estimated Time Enroute	The estimated time it takes to reach the destination waypoint from the present position, based upon current ground speed.
DF	Direct to Fix	ETA	Estimated Time of Arrival
DFLT	default	ETE	Estimated Time Enroute
DGRD	degrade	EXPIRD	expired
DH	decision height	°F	degrees Fahrenheit
Dilution of Precision	A measure of GPS satellite geometry quality on a scale of one to ten (lower numbers equal better geometry, where higher numbers equal poorer geometry).	FA	Course From Fix to Altitude
DIR	direction	FAA	Federal Aviation Administration
DIS	distance	FADEC	Full Authority Digital Engine Control
Distance	The 'great circle' distance from the present position to a destination waypoint.	FAF	Final Approach Fix
DME	Distance Measuring Equipment	FAIL	failure
DOP	Dilution of Precision	FC	Course From Fix to Distance
DP	Departure Procedure	FCC	Federal Communication Commission
DPRT	departure	FCST	forecast
DR	dead reckoning	FD	Course From Fix to DME Distance
DSBL	disabled	FD	flight director
DTK	Desired Track	FDE	Fault Detection and Exclusion
E	empty, east	FFLOW	fuel flow
ECU	Engine Control Unit	FIS-B	Flight Information Services-Broadcast
Efficiency	A measure of fuel consumption, expressed in distance per unit of fuel.	FISDL	Flight Information Service Data Link
EGT	Exhaust Gas Temperature	FL	flight level
EIS	Engine Indication System	FLC	Flight Level Change
EGNOS	European Geostationary Navigation Overlay Service	FM	Course From Fix to Manual Termination
ELEV	elevation	FMS	Flight Management System
ELEV	elevator	FOB	Fuel On Board
EMERGCY	emergency	FPL	flight plan
EMI	Electromagnetic Interference	fpm	feet per minute
ENDUR	endurance	FREQ	frequency
Endurance	Flight endurance, or total possible flight time based on available fuel on board.	FRZ	freezing
ENG	engine	FSS	Flight Service Station
ENGD	engaged	ft	foot/feet
ENR	enroute	Fuel Flow	The fuel flow rate, expressed in units of fuel per hour.
Enroute Safe Altitude	The recommended minimum altitude within ten miles left or right of the desired course on an active flight plan or direct-to.	Fuel On Board	The total amount of usable fuel on board the aircraft.
ENT	enter	G/S, GS	glideslope

GA	go-around	I	Inner Marker
gal, gl	gallon(s)	IAF	Initial Approach Fix
GBOX	gearbox	IAT	Indicated Air Temperature
GDC	Garmin Air Data Computer	ICAO	International Civil Aviation Organization
GDU	Garmin Display Unit	ICS	Intercom System
GEA	Garmin Engine/Airframe Unit	ID	Identification/Morse Code Identifier
GEO	geographic	IDENT, IDNT	identification
GFC	Garmin Flight Control	IF	Initial Fix
GIA	Garmin Integrated Avionics Unit	IFR	Instrument Flight Rules
GLS	Global Navigation Satellite Landing System	IG	Imperial gallon
GMA	Garmin Audio Panel System	ILS	Instrument Landing System
GMC	Garmin Mode Controller	IMC	Instrument Meteorological Conditions
GMT	Greenwich Mean Time	in	inch
GMU	Garmin Magnetometer Unit	INACTV	inactive
GND	ground	INC FUEL	increase fuel
gph	gallons per hour	IND	indicated
GPS	Global Positioning System	Indicated	Information provided by properly calibrated and set instrumentation on the aircraft panel.
Grid MORA	Grid Minimum Off-Route Altitude; one degree latitude by one degree longitude in size and clears the highest elevation reference point in the grid by 1000 feet for all areas of the grid	INFO	information
Groundspeed	The velocity that the aircraft is travelling relative to a ground position.	in HG	inches of mercury
Ground Track	see <i>Track</i>	INT	intersection(s)
GRS	Garmin Reference System	INTEG	integrity (RAIM unavailable)
GS	Ground speed	IrDA, IRDA	Infrared Data Association
GTX	Garmin Transponder	KEYSTK	key stuck
HA	Hold Terminating at Altitude	kg	kilogram
HDG	heading	kHz	kilohertz
Heading	The direction an aircraft is pointed, based upon indications from a magnetic compass or a properly set directional gyro.	km	kilometer
HF	Hold Terminating at Fix	kt	knot
HFOM	Horizontal Figure of Merit	L	left, left runway
Hg	mercury	LAT	latitude
HI	high	LBL	label
HI SENS	High Sensitivity	lb	pound
HM	Hold with Manual Termination	LCD	Liquid Crystal Display
Horizontal Figure of Merit	A measure of the uncertainty in the aircraft's horizontal position.	LCL	local
hPa	hectopascal	LED	Light Emitting Diode
HPL	Horizontal Protection Level	Left Over Fuel On Board	The amount of fuel remaining on board after the completion of one or more legs of a flight plan or direct-to.
hr	hour	Left Over Fuel Reserve	The amount of flight time remaining, based on the amount of fuel on board after the completion of one or more legs of a flight plan or direct-to, and a known consumption rate.
HSDB	High-Speed Data Bus	Leg	The portion of a flight plan between two waypoints.
HSI	Horizontal Situation Indicator	LIFR	Low Instrument Flight Rules
HT	heat	LNAV	Lateral Navigation
HUL	Horizontal Uncertainty Level	LO	low
Hz	Hertz	LOC	localizer

SYSTEM OVERVIEW

FLIGHT INSTRUMENTS

EIS

AUDIO PANEL & CNS

FLIGHT MANAGEMENT

HAZARD AVOIDANCE

AFCS

ADDITIONAL FEATURES

APPENDICES

INDEX

LOI	loss of integrity (GPS)	NEXRAD	Next Generation Radar
LON	longitude	nm	nautical mile(s)
LPV	Localizer Performance with Vertical guidance	NoPT	No Procedure Turn Required (procedure shall not be executed without ATC clearance)
LRU	Line Replacement Unit		
LT	left	NRST	nearest
LTNG	lightning		
LVL	level	O	Outer Marker
M	Middle Marker	OAT	Outside Air Temperature
m	meter	OBS	Omni Bearing Selector
MAG	Magnetic	OFST	offset
MAG VAR	Magnetic Variation	OXY	oxygen
MAHP	Missed Approach Hold Point	P ALT	pressure altitude
MAN IN	manifold pressure (inches Hg)	PA	Passenger Address
MAN SQ	Manual Squelch	PA	Proximity Advisory
MAP	Missed Approach Point	PASS	passenger(s)
MASQ	Master Avionics Squelch	PC	personal computer
MAX	maximum	PDF	Primary Flight Display
MAXSPD	maximum speed (overspeed)	PI	Procedure Turn to Course Intercept
MDA	barometric minimum descent altitude	PIT, PTCH	pitch
MET	manual electric trim	POSN	position
METAR	Meteorological Aviation Routine	PPM	parts per million
MEPT	manual electric pitch trim	P. POS	Present Position
MFD	Multi Function Display	PRES, PRESS	pressure
MGRS	Military Grid Reference System	PROC	procedure(s), procedure turn
MHz	megahertz	psi	pounds per square inch
MIC	microphone	PT	Procedure Turn
MIN	minimum	PTK	parallel track
Minimum Safe Altitude	Uses Grid MORAs to determine a safe altitude within ten miles of the aircraft present position.	PTT	Push-to-Talk
		PWR	power
MKR	marker beacon	QTY	quantity
MOA	Military Operations Area		
MOV	movement	R	right, right runway
mpm	meters per minute	RAD	radial
MSA	Minimum Safe Altitude	RAIM	Receiver Autonomous Integrity Monitoring
MSAS	Multi-functional Satellite Augmentation System	RAM	random access memory
MSG	message	REF	reference
MSL	Mean Sea Level	REM	remaining (fuel remaining above Reserve)
MT	meter		
mV	millivolt(s)	REQ	required
MV DB	Magnetic Variation Database	RES	reserve (fuel reserve entered by pilot)
MVFR	Marginal Visual Flight Rules	REV	reverse, revision, revise
		RF	Constant Radius Turn to Fix
N	north	RMI	Radio Magnetic Indicator
NAV	navigation	RMT	remote
NAVAID	NAVigation AID	RNG	range
NDB	Non-directional Beacon	RNWX	runway

ROL	roll	TCAS	Traffic Collision Avoidance System
ROM	read only memory	TEL	telephone
rpm	revolutions per minute	TEMP	temperature
RST FUEL	reset fuel	TERM	terminal
RSV	reserve (fuel reserve entered by pilot)	TF	Track Between Two Fixes
RT	right	TFR	Temporary Flight Restriction
RVRSNRY	reversionary	T HDG	True Heading
RX	receive	TIS	Traffic Information System
		TIT	Turbine Inlet Temperature
S	south	TKE	Track Angle Error
SA	Selective Availability	TMA	Terminal Maneuvering Area
SAT	Static Air Temperature	TMR/REF	Timer/Reference
SBAS	Satellite-Based Augmentation System	Topo	topographic
SCIT	Storm Cell Identification and Tracking	Track	Direction of aircraft movement relative to a ground position; also 'Ground Track'
SD	Secure Digital		
sec	second(s)		
SEL, SLCT	select	Track Angle Error	The angle difference between the desired track and the current track.
SFC	surface		
SIAP	Standard Instrument Approach Procedures	TRG	target
		TRK	track
SID	Standard Instrument Departure	TRSA	Terminal Radar Service Area
SIGMET	Significant Meteorological Information	TRUNC	truncated
Sim	simulator	TTL	total
SLP/SKD	slip/skid	TURN	procedure turn
SMBL	symbol	TX	transmit
SPD	speed		
SPI	Special Position Identification	UNAVAIL	unavailable
SPKR	speaker	USR	user
SQ	squelch	UTC	Coordinated Universal Time
SRVC, SVC	service	UTM/UPS	Universal Transverse Mercator / Universal Polar Stereographic Grid
STAL	stall		
STAR	Standard Terminal Arrival Route		
STATS	statistics	V, Vspeed	velocity (airspeed)
STBY	standby	VA	Heading Vector to Altitude
STD	standard	VAPP	VOR approach
SUA	Special Use Airspace	VAR	variation
SUSP	suspend	VD	Heading Vector to DME Distance
SVS	Synthetic Vision System	Vdc	volts, direct current
SW	software	VERT	vertical
SYS	system	Vertical Figure of Merit	A measure of the uncertainty in the aircraft's vertical position.
		Vertical Speed Required	The vertical speed necessary to descend/climb from a current position and altitude to a defined target position and altitude, based upon current groundspeed.
T	true		
TA	Traffic Advisory		
TACAN	Tactical Air Navigation System		
TAF	Terminal Aerodrome Forecast		
TAS	True Airspeed	VFOM	Vertical Figure of Merit
TAS	Traffic Advisory System, true airspeed	VFR	Visual Flight Rules
TAT	Total Air Temperature	VHF	Very High Frequency
TAWS	Terrain Awareness and Warning System	VI	Heading Vector to Intercept
TCA	Terminal Control Area	VLOC	VOR/Localizer Receiver

- SYSTEM OVERVIEW
- FLIGHT INSTRUMENTS
- EIS
- AUDIO PANEL & CNS
- FLIGHT MANAGEMENT
- HAZARD AVOIDANCE
- AFCS
- ADDITIONAL FEATURES
- APPENDICES
- INDEX

VM	Heading Vector to Manual Termination
VMC	Visual Meteorological Conditions
VNAV, VNV	vertical navigation
VOL	volume
VOR	VHF Omni-directional Range
VORTAC	very high frequency omnidirectional range station and tactical air navigation
VPL	Vertical Protection Level
VPROF	VNV profile, vertical profile
VPTH	VNV path, vertical path
VR	Heading Vector to Radial
VS	vertical speed
VSI	Vertical Speed Indicator
VSR	Vertical Speed Required
VTF	vector to final
W	watt(s), west
WAAS	Wide Area Augmentation System
WARN	warning (GPS position error)
WGS-84	World Geodetic System - 1984
WPT	waypoint(s)
WW	world wide
WX	weather
XFER, XFR	transfer
XPDR	transponder
XTALK	cross-talk
XTK	cross-track

FREQUENTLY ASKED QUESTIONS

If a particular aspect of G1000 operational capability is not addressed by these commonly asked questions or in the index, contact Garmin (see the copyright page or back cover for contact information) or a Garmin-authorized dealer. Garmin is dedicated to supporting its products and customers.

WHAT IS SBAS?

The Satellite Based Augmentation System (SBAS) uses a system of ground stations to correct any GPS signal errors. These ground stations correct for errors caused by ionospheric disturbances, timing, and satellite orbit errors. It also provides vital integrity information regarding the health of each GPS satellite. The signal correction is then broadcast through geostationary satellites. This correction information can then be received by any SBAS-enabled GPS receiver.

SBAS is designed to provide the additional accuracy, availability, and integrity necessary to enable users to rely on GPS for all phases of flight.

There are several SBAS systems serving different parts of the world. The Wide Area Augmentation System (WAAS) is currently available in the United States, including Alaska and Hawaii. The European Geostationary Navigation Overlay Service (EGNOS) offers coverage of Europe, parts of the middle east and northern Africa. The Multi-functional Satellite Augmentation System (MSAS) covers mainly Japan and parts of northern Australia.

HOW DOES SBAS AFFECT APPROACH OPERATIONS?

Both LNAV/VNAV and LPV approaches use the accuracy of SBAS to include vertical (glide path) guidance capability. The additional accuracy and vertical guidance capability allows improved instrument approaches to an expanded number of airports throughout the U.S.

The implementation of LPV approaches further improves precision approach capabilities. LPV approaches are designed to make full use of the improved GPS signal from the SBAS. This approach combines the LNAV/VNAV vertical accuracy with lateral guidance similar to the typical Instrument Landing System (ILS). LPV approaches allow lower approach minimums.

WHAT IS RAIM AND HOW DOES IT AFFECT APPROACH OPERATIONS?

In systems using the GIA 63, or when SBAS is unavailable, the GPS receivers use Receiver Autonomous Integrity Monitoring (RAIM) to perform the following functions:

- Monitor and verify integrity and geometry of tracked GPS satellites
- Notify pilot when satellite conditions do not provide necessary coverage to support a certain phase of flight
- Predict satellite coverage of a destination area to determine whether the number of available satellites is sufficient to satisfy requirements (refer to the System Overview Section for instructions on RAIM prediction)
- Detect and exclude bad satellites from the navigation solution (Fault Detection and Exclusion, FDE)

RAIM ensures that satellite geometry allows for a navigation solution calculation within a specified protection limit (4.0 nm for oceanic, 2.0 nm for enroute, 1.0 nm for terminal, and 0.3 nm for non-precision approaches). Without SBAS or RAIM, GPS position accuracy integrity cannot be monitored.



NOTE: If RAIM is not predicted to be available for the final approach course, the approach does not become active, as indicated by the “RAIM not available from FAF to MAP” message and the LOI annunciation flagging on the HSI.

For RAIM to work correctly, the GPS receiver must track at least five satellites. A minimum of six satellites is required to allow RAIM to eliminate a single corrupt satellite from the navigation solution.

RAIM ensures that satellite geometry allows for a navigation solution calculation within a specified protection limit (2.0 nm for oceanic and en route, 1.0 nm for terminal, and 0.3 nm for non-precision approaches). The G1000 System monitors RAIM and issues an alert message when RAIM is not available (see Appendix A). Without RAIM, GPS position accuracy cannot be monitored. If RAIM is not available when crossing the FAF, the pilot must fly the missed approach procedure.

WHY ARE THERE NOT ANY APPROACHES AVAILABLE FOR A FLIGHT PLAN?

Approaches are available for the final destination airport in a flight plan or as a direct-to (keep in mind that some VOR/VORTAC identifiers are similar to airport identifiers). If a destination airport does not have a published approach, the G1000 indicates “NONE” for the available procedures.

WHAT HAPPENS WHEN AN APPROACH IS SELECTED? CAN A FLIGHT PLAN WITH AN APPROACH, A DEPARTURE, OR AN ARRIVAL BE STORED?

When an approach, departure, or arrival is loaded into the active flight plan, a set of approach, departure, or arrival waypoints is inserted into the flight plan, along with a header line showing the title of the selected instrument procedure. The original en route portion of the flight plan remains active, unless the instrument procedure is activated. This may be done either when the procedure is loaded or at a later time.

Flight plans can also be stored with an approach, a departure, or an arrival. Note that the active flight plan is erased when the system is turned off. Also, the active flight plan is overwritten when another flight plan is activated. When storing flight plans with an approach, a departure, or an arrival, the G1000 uses the waypoint information from the current database to define the waypoints. If the database is changed or updated, the G1000 System automatically updates the information, provided the procedure has not been modified. Should an approach, departure, or arrival procedure no longer be available, the flight plan becomes locked until the procedure is deleted from the flight plan.

CAN “SLANT GOLF” (“/G”) BE FILED USING THE G1000?

“/G” may be filed for a flight plan. The G1000 System meets the requirements of TSO-C145a Class 3 and ETSO C145 Class 3 installations. GPS approaches are not to be flown with an expired database. See the approved Pilot’s Operating Handbook (POH) as well as the Aeronautical Information Manual (AIM) for more information.

WHAT DOES THE OBS SOFTKEY DO?

The **OBS** Softkey is used to select manual sequencing of waypoints. Activating OBS mode sets the current active-to waypoint as the primary navigation reference and prevents the system from sequencing to the next waypoint in a flight plan. When OBS mode is cancelled, automatic waypoint sequencing is continued, and the G1000 automatically activates the next waypoint in the flight plan once the aircraft has crossed the present active waypoint.

Normal (OBS not activated)

- Automatic sequencing of waypoints
- Manual course change on HSI not possible
- Always navigates 'TO' the active waypoint
- Must be in this mode for final approach course

OBS

- Manual sequencing - 'holds' on selected waypoint
- Manually select course to waypoint from HSI
- Indicates 'TO' or 'FROM' waypoint
- Cannot be set for final approach course or published holding patterns

When OBS mode is active, the G1000 allows the pilot to set a desired course to/from a waypoint using the **CRS/BARO** Knob and HSI (much like a VOR).

The most common application for using the **OBS** Softkey is the missed approach. The G1000 suspends automatic waypoint sequencing (indicated by a 'SUSP' annunciation placed on the HSI) when the missed approach point (MAP) is crossed. This prevents the G1000 from automatically sequencing to the missed approach holding point (MAHP). During this time, the **OBS** Softkey designation changes to **SUSP**. Pressing the **SUSP** Softkey reactivates automatic waypoint sequencing. The **OBS** Softkey then resumes its normal functionality.

WHY DOES THE G1000 NOT AUTOMATICALLY SEQUENCE TO THE NEXT WAYPOINT?

The G1000 only sequences flight plan waypoints when automatic sequencing is enabled (i.e., no "OBS" or "SUSP" annunciation). For automatic sequencing to occur, the aircraft must also cross the "bisector" of the turn being navigated. The bisector is a line passing through the waypoint common to two flight plan legs at an equal angle from each leg.

HOW CAN A WAYPOINT BE SKIPPED IN AN APPROACH, A DEPARTURE, OR AN ARRIVAL?

The G1000 allows the pilot to manually select any approach, departure, or arrival leg as the active leg of the flight plan. This procedure is performed on the MFD from the Active Flight Plan Page by highlighting the desired waypoint and selecting the **ACT LEG** Softkey then the **ENT** Key to approve the selection. The GPS then provides navigation along the selected flight plan leg.

WHEN DOES TURN ANTICIPATION BEGIN?

The G1000 smooths adjacent leg transitions based on a normal 15° bank angle (with the ability to roll up to 30°) and provides three pilot cues for turn anticipation:

- A waypoint alert ('Next DTK ###° in # seconds' or 'Next HDG ###° in # seconds') appears on the PFD 10 seconds before the turn point and flashes as it counts down to zero.
- A flashing turn advisory ('Turn [right/left] to ###° in # seconds') appears on the PFD 10 seconds before the turn and flashes as it counts down to zero. 'Turn [right/left] to ###° now' or 'Next [DTK/HDG] to ###° now' is displayed when the pilot is to begin the turn and the HSI (GPS mode) automatically sequences to the next DTK or HDG value.
- The To/From indicator on the HSI flips momentarily to indicate that the midpoint of the turn has been crossed.

WHEN DOES THE CDI SCALE CHANGE?

Once a departure is activated, the G1000 Course Deviation Indicator (CDI) full scale deflection is set to 0.3 nm. The CDI scale changes to 1.0 nm (terminal mode) then ramps up to 2.0 nm (enroute mode) at 30 nm from the departure airport. When 31 nm from the destination, the CDI scale smoothly transition from 2.0 nm back to 1.0 nm (terminal mode). At 2.0 nm before the FAF during an active approach, the CDI scale transitions down further based on the type of approach activated (LNAV, LNAV/VNAV, LPV). When a missed approach is activated, the CDI is set to 0.3 nm. See the Flight Instruments Section for more details on CDI scaling.

WHY DOES THE HSI NOT RESPOND LIKE A VOR WHEN OBS MODE IS ACTIVE?

Unlike a VOR, the CDI scale used on GPS equipment is based on the crosstrack distance to the desired course, not on the angular relationship to the destination. Therefore, the CDI deflection on the GPS is constant regardless of the distance to the destination and does not become less sensitive when further away from the destination.

WHAT IS THE CORRECT MISSED APPROACH PROCEDURE? HOW IS THE MISSED APPROACH HOLDING POINT SELECTED?

To comply with TSO specifications, the G1000 does not automatically sequence past the MAP. The first waypoint in the missed approach procedure becomes the active waypoint when the **SUSP** Softkey is selected *after* crossing the MAP. All published missed approach procedures must be followed, as indicated on the approach plate.

To execute the missed approach procedure prior to the MAP (not recommended), select the Active Flight Plan Page and use the **ACT LEG** Softkey to activate the missed approach portion of the procedure.

AFTER A MISSED APPROACH, HOW CAN THE SAME APPROACH BE RE-SELECTED? HOW CAN A NEW APPROACH BE ACTIVATED?



NOTE: Do not attempt to reactivate the current approach prior to crossing the missed approach point (MAP). If an attempt to do so is made, an alert message "Are you sure you want to discontinue the current approach?" appears. The G1000 directs the pilot back to the transition waypoint and does not take into consideration any missed approach procedures, if the current approach is reactivated.

After flying the missed approach procedure, the pilot may reactivate the same approach for another attempt by pressing the **PROC** Key. Once the clearance is given for another attempt, activate the approach by highlighting 'ACTIVATE APPROACH' using the large **FMS** Knob and pressing the **ENT** Key. The G1000 provides navigation along the desired course to the waypoint and rejoins the approach in sequence from that point.

To activate a new approach for the same airport, select the new procedure by pressing the **PROC** Key. Choose 'SELECT APPROACH', select the desired approach from the list shown, and press the **ENT** Key. Select the desired transition, then activate the approach using the **ENT** Key.

To activate a new approach to a different airport, press the **Direct-to** Key and select the desired airport using the **FMS** Knobs. Press the **ENT** Key to accept the selected airport, then follow the steps in the preceding paragraph to select an approach for the new airport.

GENERAL TIS INFORMATION

INTRODUCTION

 **NOTE:** Aircraft without an operating transponder are invisible to TIS.

The Traffic Information Service (TIS) provides traffic advisory information to non-TAS/TCAS-equipped aircraft. TIS is a ground-based service providing the relative locations of all ATCRBS Mode-A and Mode-C transponder equipped aircraft within a specified service volume. The TIS ground sensor uses real-time track reports to generate traffic notification. The G1000 System displays TIS traffic information on the Traffic Map Page of the MFD. TIS information may also be displayed for overlay on the MFD Navigation Map Page, as well as on the PFD Inset Map. Surveillance data includes all transponder-equipped aircraft within the coverage volume. The G1000 System displays up to eight traffic targets within a 7.5 nm radius, from 3,000 feet below, to 3,500 feet above the requesting aircraft.

TIS VS. TAS/TCAS

The Traffic Information System (TIS) is a ground-based service that requires contact with a ground station through a datalink radio in order to receive traffic information. Traffic Advisory (TAS) and Traffic Collision Avoidance Systems (TCAS) are self-contained. TAS/TCAS uses an airborne interrogator with a half-second update rate, while TIS utilizes the terminal Mode-S ground interrogator and accompanying data link to provide a five-second update rate. TIS and TAS/TCAS have similar ranges.

TIS LIMITATIONS

 **NOTE:** TIS is not intended to be used as a collision avoidance system and does not relieve the pilot of the responsibility to “see and avoid” other aircraft. TIS shall not be used for avoidance maneuvers during instrument meteorological conditions (IMC) or when there is no visual contact with the intruder aircraft.

 **NOTE:** Refer to the TIS Limitations section of the Aeronautical Information Manual (AIM) for a more comprehensive explanation.

TIS relies on surveillance of the Mode-S radar system, which is a “secondary surveillance” radar system similar to that used by ATCRBS. Many limitations are inherent in secondary radar surveillance. Information provided by TIS is neither better nor more accurate than the information used by ATC. TIS is intended only to assist in visual acquisition of other aircraft in visual meteorological conditions (VMC). While TIS is a useful aid for visual traffic avoidance, system limitations must be considered to ensure proper use. No recommended avoidance maneuvers are given, nor authorized, as a direct result of a TIS intruder display or TIS advisory.

- TIS operation may be intermittent during turns or other maneuvering.
- TIS is dependent on two-way, line-of-sight communications between the aircraft and the Mode-S radar antenna. Whenever the structure of the aircraft comes between the transponder antenna and the ground-based radar antenna, the signal may be temporarily interrupted.
- Other limitations and anomalies associated with TIS are described in the AIM.



WARNING: Garmin is not responsible for Mode S geographical coverage. Operation of the ground stations is the responsibility of the FAA. Refer to the AIM for a Terminal Mode S radar site map.



NOTE: TIS is unavailable at low altitudes in many areas of the United States. This is often the case in mountainous regions.

TIS information is collected during a single radar sweep. Collected information is then sent through the Mode S uplink on the next radar sweep. Because of this, the surveillance information is approximately five seconds old. TIS ground station tracking software uses prediction algorithms to compensate for this delay. These algorithms use track history data to calculate expected intruder positions consistent with the time of display. Occasionally, aircraft maneuvering may cause variations in this calculation and create slight errors on the Traffic Map Page. Errors affect relative bearing information and target track vector. This can cause a delay in the displayed intruder information. However, intruder distance and altitude typically remain relatively accurate and may be used to assist in spotting traffic.

The following errors are common examples:

- When the client or intruder aircraft maneuvers excessively or abruptly, the tracking algorithm may report incorrect horizontal position until the maneuvering aircraft stabilizes.
- When a rapidly closing intruder is on a course that intercepts the client aircraft course at a shallow angle (either overtaking or head-on) and either aircraft abruptly changes course within 0.25 nm, TIS may display the intruder aircraft on the incorrect side of the client aircraft.

These are rare occurrences and are typically resolved within a few radar sweeps once the client/intruder aircraft course stabilizes.

Pilots using TIS can provide valuable assistance in the correction of malfunctions by reporting observations of undesirable performance. Reports should identify the time of observation, location, type and identity of the aircraft, and describe the condition observed. Reports should also include the type of transponder and transponder software version. Since TIS performance is monitored by maintenance personnel, not ATC, malfunctions should be reported in the following ways:

- By telephone to the nearest Flight Service Station (FSS) facility
- By FAA Form 8000-7, Safety Improvement Report (postage-paid card can be obtained at FAA FSSs, General Aviation District Offices, Flight Standards District Offices, and General Aviation Fixed Base Operators)

MAP SYMBOLS

AIRPORT

Item	Symbol
Unknown Airport	
Non-towered, Non-serviced Airport	
Towered, Non-serviced Airport	
Non-towered, Serviced Airport	
Towered, Serviced Airport	
Restricted (Private) Airport	
Helicopter	

NAVAIDS

Item	Symbol
Intersection	
LOM (compass locator at outer marker)	
NDB (Non-directional Radio Beacon)	
VOR	
VOR/DME	
VOR/ILS	
VORTAC	
TACAN	

BASEMAP

Item	Symbol
Interstate Highway	
State Highway	
US Highway	
National Highway	
Small City or Town	
Medium City	
Large City	

TIS AND TAS TRAFFIC

Item	Symbol
Non-Threat Traffic	
Proximity Advisory (TAS only)	
Traffic Advisory, Out of Range	
Traffic Advisory	

SYSTEM OVERVIEW

FLIGHT INSTRUMENTS

EIS

AUDIO PANEL & CNS

FLIGHT MANAGEMENT

HAZARD AVOIDANCE

AFCS

ADDITIONAL FEATURES

APPENDICES

INDEX

ADS-B TRAFFIC

Item	Symbol
Non-Threat Traffic without directional information	
Ground traffic without directional information	
Traffic Advisory, Out of Range	
Traffic Advisory without directional information	
Non-aircraft ground traffic	
Traffic with directional information, but positional accuracy is degraded. Points in the direction of the aircraft track	
Traffic Advisory with directional information. Points in the direction of the intruder aircraft track.	
Traffic located on the ground with directional information. Points in the direction of the aircraft track.	
Non-threat traffic with directional information. Points in the direction of the aircraft track.	

LINE SYMBOLS

Item	Symbol
ICAO Control Area Class B Airspace	
Mode C Tower Area	
Warning Area Alert Area Caution Area Danger Area Prohibited Area Restricted Area Training Area Unknown Area	
Class C Terminal Radar Service Area Mode C Area	
Military Operations Area (MOA)	
State or Province Border	

LINE SYMBOLS

Item	Symbol
International Border	
Road	
Railroad	
Latitude/Longitude	

OBSTACLE SYMBOLS

Obstacle Symbol	Unlighted Obstacle		Lighted Obstacle		Obstacle Color	Obstacle Location
	< 1000 ft AGL	> 1000 ft AGL	< 1000 ft AGL	> 1000 ft AGL		
				Red	Obstacle within 100 ft or above aircraft altitude	
				Yellow	Obstacle within 1000 ft of aircraft altitude	
				Gray	Obstacle more than 1000 ft below aircraft altitude	

Obstacle Symbols and Colors

TERRAIN PROXIMITY COLOR CHART

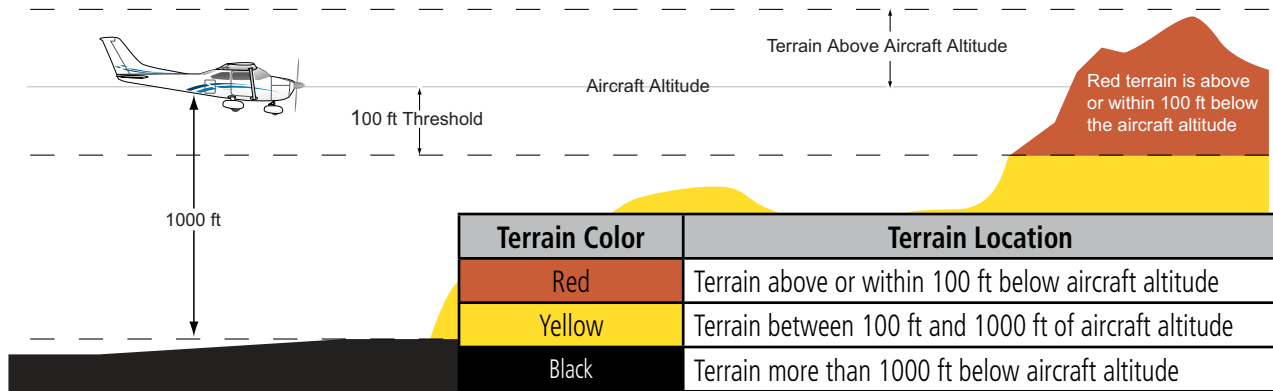

Terrain Proximity Colors

TERRAIN-SVS AND TAWS COLOR CHART

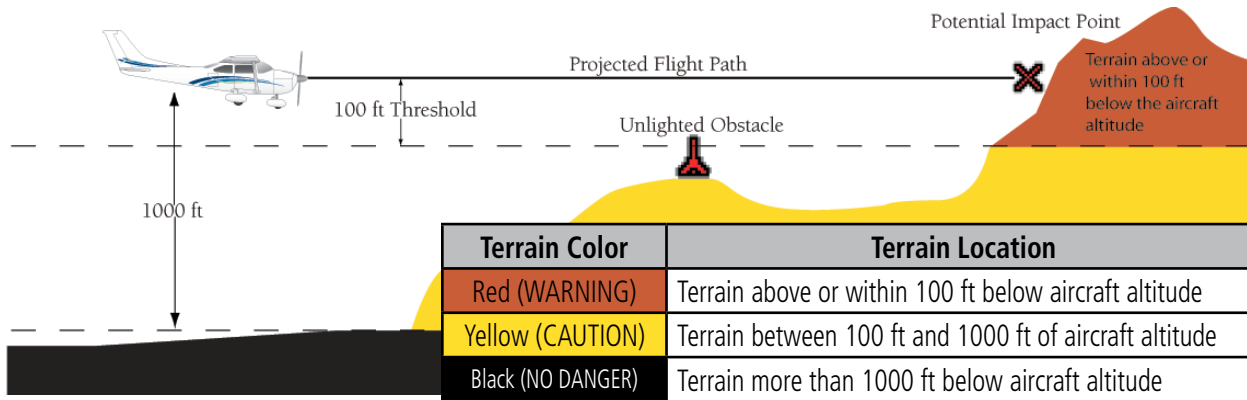





















TAWS Symbols & Colors

MISCELLANEOUS

Item	Symbol
ARTCC Frequency or FSS Frequency	
Default Map Pointer	
Elevation Pointer	
Wind Vector	
Measuring Pointer	
Overzoom Indicator	
Terrain Proximity or TAWS Enabled	
Traffic Enabled	

Item	Symbol
User Waypoint	
Vertical Navigation Along Track Waypoint	
Parallel Track Waypoint	
Unanchored Flight Path Waypoint	
Top of Descent (TOD)	
Bottom of Descent (BOD)	
Navigating using Dead Reckoning	

HAZARD AVOIDANCE FEATURES

Feature	Symbol
Terrain Proximity/TAWS display enabled	
Traffic display enabled	
NEXRAD/PRECIP display enabled	
Cloud Top display enabled	
Echo Top display enabled	
XM Lightning display enabled	
Cell Movement display enabled	
SIGMETs/AIRMETs display enabled	
METARs display enabled	
City Forecast display enabled	
Surface Analysis display enabled	
Freezing Levels display enabled	
Winds Aloft display enabled	
County Warnings display enabled	
Cyclone Warnings display enabled	
Icing Potential (CIP and SLD) (ICNG)	
Pilot Weather Report (PIREPs)	
Air Report (AIREPs)	
Turbulence (TURB)	
Loss of hazard avoidance feature (due to loss of GPS position)	

SYSTEM OVERVIEW

FLIGHT INSTRUMENTS

EIS

AUDIO PANEL & CNS

FLIGHT MANAGEMENT

HAZARD AVOIDANCE

AFCS

ADDITIONAL FEATURES

APPENDICES

INDEX

SYSTEM OVERVIEW

FLIGHT INSTRUMENTS

EIS

AUDIO PANEL & CNS

FLIGHT MANAGEMENT

HAZARD AVOIDANCE

AFCS

ADDITIONAL FEATURES

APPENDICES

INDEX

BLANK PAGE

A

Access code-----	314
Activate a Flight Plan-----	208
Active channel-----	541
Active database-----	584, 585
Active frequency-----	100, 109
ADS-B-----	402, 425
AFCS status annunciation-----	49
AFCS Status Box-----	433
AHRS-----	574
Aircraft alerts-----	562
Air Data Computer-----	1
Airport	
Information-----	169
Nearest-----	39
Airspace alerts-----	184
Airspace Alerts-----	184
Airspeed indicator-----	50
Airspeed Reference-----	440, 477
Airways	
Collapsed-----	222
Expanded-----	222
Alerting system-----	561
Alerting System-----	563
Alert levels-----	562
Alerts-----	561
Airspace-----	36
Arrival-----	37
Audio voice-----	37
Alerts window-----	73
Along Track Offset-----	214
ALT-----	271
Altimeter-----	53
Altitude	
Constraints-----	258
Altitude alerting-----	76
Altitude buffer-----	36
Altitude capture-----	446
Altitude constraints-----	225
Altitude hold-----	9
Altitude Hold-----	9
Altitude Hold Mode (ALT)-----	437
Altitude Reference-----	437, 438, 446
ALT knob-----	9
Ammeter-----	84–85, 91–92
Annunciations	
Test tone-----	41
Annunciations, G1000 System-----	17, 563
Annunciation window-----	49
AOPA Airport Directory-----	312, 536, 537, 538, 588
AP-----	9, 578
Approach-----	600
Activating-----	238
ILS-----	470
Loading-----	206, 235, 237
Missed-----	474
Removing-----	238
WAAS-----	472
Approach box-----	522
Approach Mode, AFCS-----	470, 472
Approach Mode (GPS, VAPP, LOC)-----	456
APR softkey-----	237, 243
Arrival Alerts-----	37
Arrival procedure-----	190, 204, 232, 233, 234, 256, 258, 267
Attitude-----	1
Attitude and Heading Reference System (AHRS)-----	13, 15–16
Attitude indicator-----	52
Audio alerting system-----	561
Audio Panel-----	15
Audio panel controls	
SPKR-----	125
Audio panel fail-safe operation-----	131
Aural alerts-----	566
Automatic audio muting-----	544
Automatic Dependent Surveillance - Broadcast-----	402
Automatic Flight Control System (AFCS)-----	429–478
Alerts-----	578
Alerts and annunciations-----	477–478
Controls-----	430–431
Example procedures-----	461–468
Status Box-----	433
Automatic squelch-----	108
Autopilot-----	429, 459–460, 578
Autopilot disconnect-----	431, 450, 460
Auto-tuning-----	116
Auto-tuning, COM-----	103
Auto-tuning, NAV-----	112
Auto Zoom-----	138
Auxiliary Pages (AUX)-----	32
AUX - system status page-----	496, 498, 517, 518, 533, 534, 535, 537
Aviation Symbols-----	149, 190
B	
Backcourse Mode-----	458
Backlighting-----	14, 44, 45
Barometric altimeter setting-----	54
Battery current-----	84–85, 91–92
Bearing/distance, measuring-----	143
Bearing information-----	49, 61
Bearing pointer-----	60
Bearing source-----	61
Bus voltage-----	84, 91

SYSTEM OVERVIEW

FLIGHT INSTRUMENTS

EIS

AUDIO PANEL & CNS

FLIGHT MANAGEMENT

HAZARD AVOIDANCE

AFCS

ADDITIONAL FEATURES

APPENDICES

INDEX

C

Calibrated Airspeed-----240

CAUTION-----562

CDI-----234, 247, 258, 266, 273, 575

CELL MOV Softkey-----295

Chart Not Available-----500, 520

Chart options-----508, 527

Chart setup box-----514, 531

ChartView-----479, 499, 517

ChartView database-----517

ChartView functions-----499

ChartView plan view-----509

ChartView profile view-----510

ChartView softkeys-----499

Checklists-----547–548

Checklist softkeys-----547

CLD TOP Softkey-----293, 329

Clearance recorder-----128

Closest Point-----222

CLR-----8

CNS system-----95

COM channel spacing-----107

COM frequency box-----100

Command Bars, flight director-----434

COM radio

 Channel spacing-----39

COM tuning failure-----131

Controls-----7

 AFCS-----430–431

 Softkeys-----17–20

Control Wheel Steering (CWS)-----431, 460

Copy a Flight Plan-----209

Course deviation indicator-----62

Course Deviation Indicator (CDI)-----39

Course To Altitude-----239

Cylinder Head Temperature (CHT)-----83–85, 86–89

D

Data Bar fields, MFD-----38

Databases-----13, 583

Database Synchronization-----584, 588, 589, 590

Data link-----1

Datalink receiver troubleshooting-----557

Data logging-----551

Date and time-----35

Day/Night views-----514, 531

Day view-----514, 515, 531, 532

DB Mismatch-----583

Dead reckoning-----78

Dead Reckoning Mode-----78

Decision height (DH)-----49, 77

Declutter, display-----79

Delete a Stored Flight Plan-----209

Deleting an entire airway-----211, 212

Deleting an entire procedure-----211, 212

Deleting an individual waypoint-----210, 211

Deleting Flight Plan Items-----210

Density Altitude-----242

Departure

 Select-----229, 232, 235, 238

 Timer-----42

Departure procedure-----202, 216, 229, 231

Departure Time-----240

Digital audio entertainment-----4

Dilution of Precision (DOP)-----26

Direct-to 162, 185, 186, 187, 188, 189, 223, 224, 256, 258, 273

Display backup-----15, 99, 131

DME

 HOLD mode-----118

 NAV1 mode-----118

DME information-----49, 60, 61

DME transceiver pairing-----118

DME tuning window-----118

Dual navigation database-----585

E

ECHO TOP Softkey-----292

Electronic checklists-----479–480, 547, 548, 549

Emergency checklist-----548

Emergency frequency-----131

Engine Display (EIS)-----83–85

Engine hours-----84, 90–92

Engine Indication System (EIS)-----81–94

Engine Leaning Assist-----86, 88, 89

Engine manifold pressure-----83–85, 87–89, 91–93

Entering flight ID-----119

Entertainment audio-----129

Entertainment inputs-----129

Estimated Position Error (EPE)-----26

Ethernet-----2

Exhaust Gas Temperature (EGT)-----83–84, 86–89

F

Fail-safe operation-----131

FD-----9, 578

Field of View (SVS)-----160

FLC-----9

Flight Data Logging-----479, 550

Flight director-----429, 432–433

 Pitch modes-----435–441

 Roll modes-----451

Flight instruments-----47, 50

Flight level change-----9

Flight Level Change Mode-----468

Flight Level Change Mode (FLC)-----440, 466, 477

- Flight plan
 - Closest point to reference ----- 222
 - Storing ----- 600
- Flight plan import/export messages ----- 577
- Flight timer ----- 42
- FliteCharts ----- 479, 519
- FliteCharts® ----- 479
- FliteCharts cycle ----- 534
- FliteCharts expiration ----- 534
- FliteCharts functions ----- 519
- FPA ----- 225, 263
- Frequency
 - Nearest ----- 181
- Frequency spacing ----- 107
- Frequency toggle key ----- 8
- Frequently asked questions ----- 599
- Fuel
 - Calculations ----- 90–92
 - Efficiency ----- 242
 - Endurance ----- 242
 - Flow ----- 83–85, 87–89, 91–93
 - Quantity ----- 84–86, 87–88, 91–92
 - Remaining ----- 91–92, 242
 - Required ----- 242
 - Used ----- 91–92
- Fuel on Board ----- 242
- Fuel Statistics ----- 242

G

- GDC 74A ----- 1
- GDL 69/69A ----- 1, 278
- GDL 90 ----- 423
- GDU 1040 ----- 1
- GEA 71 ----- 1
- geodetic sea level ----- 364, 372, 381
- GFC 700 AFCS ----- 429–478
- GIA 63 ----- 1
- Glidepath ----- 271
- Glidepath indicator ----- 56
- Glidepath Mode (GP) ----- 447, 456, 472
- Glideslope ----- 271
- Glideslope indicator ----- 49, 56
- Glideslope Mode (GS) ----- 431, 449, 470
- Global Positioning System (GPS)
 - Navigation ----- 185–276
 - Receiver information ----- 25–27
- GMA 1347 ----- 1, 44
- GMU 44 ----- 1
- Go Around Mode (GA) ----- 431, 450, 474–475
- GPS Window ----- 589
- Groundspeed ----- 43
- GRS 77 ----- 1
- GSL ----- 364, 372, 381

- GTX 33 ----- 1, 3
- GTX 33 Transponder ----- 119

H

- Heading Select ----- 8, 9
- Heading Select Mode (HDG) ----- 453, 462
- HI SENS ----- 117
- Horizontal situation indicator ----- 57
- HSI double green arrow ----- 109
- HSI magenta arrow ----- 109
- HSI single green arrow ----- 109

I

- ID indicator ----- 111
- ILS approach ----- 470
- Indicated airspeed ----- 50
- Indicated Altitude ----- 240
- INFO box ----- 523
- Inset map ----- 49
- Inset Map ----- 18, 22
- Intercom system (ICS) ----- 129
- Intercom volume and squelch ----- 127
- Intersection
 - Information ----- 170–171
- Inverting a flight plan ----- 209
- IOI ----- 378, 388, 579, 580

J

- Jeppesen aviation database ----- 583

K

- Key(s) ----- 9

L

- Land Symbols ----- 148
- Lean Display (EIS) ----- 86–89
- Lightning ----- 22
- LNAV ----- 247
- Log file ----- 551
- Logging data ----- 550
- LO SENS ----- 117
- LPV ----- 247, 273
- LPV approach ----- 461

M

- Magnetometer ----- 1
- Manual Electric Trim (MET) ----- 429, 431, 459
- Map pages ----- 31
- Map Panning ----- 140
- Map symbols ----- 605
- Marker beacon ----- 117
- Marker beacon annunciations ----- 49, 74

SYSTEM OVERVIEW

FLIGHT INSTRUMENTS

EIS

AUDIO PANEL & CNS

FLIGHT MANAGEMENT

HAZARD AVOIDANCE

AFCS

ADDITIONAL FEATURES

APPENDICES

INDEX

MASQ processing ----- 95

Measurement units, changing displayed ----- 35

Menus ----- 29

Message advisories 562, 566, 567, 568, 569, 570, 571, 572, 573, 574, 575, 576, 577

MET ----- 578

MFD Data Bar fields ----- 38

Minimum descent altitude (MDA) ----- 49, 77

Minimums ----- 566

Missed Approach ----- 190, 239, 244, 247, 273, 474

Mistrim ----- 578

MKR/MUTE ----- 117

Mode S ----- 119, 120

Mode selection softkeys ----- 120, 123

Morse code identifier ----- 111

Multi Function Display (MFD)
Softkeys ----- 21

N

National Weather Service ----- 304

Navigation database ----- 225, 226, 568

Navigation Map ----- 187

Navigation Mode, AFCS ----- 464–465

Navigation mode selection ----- 109

Navigation Mode (VOR, GPS, LOC, BC) ----- 454

Navigation source ----- 62–63

NAV radio selection ----- 109

Nearest
Airports ----- 39, 181–184
VOR ----- 181–182

nearest airport ----- 166, 167, 168

Nearest Airport ----- 166, 167, 168, 169, 237
Minimum Runway Length ----- 169
Surface Matching ----- 169

Nearest Airports Page ----- 167, 168, 169

Nearest Pages (NRST) ----- 33

NEXRAD ----- 18, 22

NEXRAD Softkey ----- 288, 326, 351

Night view ----- 514, 515, 531, 532

Non-path descent ----- 445, 468–469

Normal display operation ----- 14

Normal operating mode ----- 14

O

OBS mode ----- 67

Obstacles ----- 568, 571

Odometer ----- 43

Oil pressure ----- 83–85, 91–93

Oil temperature ----- 83–85, 91–93

Omni Bearing Selector (OBS) ----- 600–601

Other Statistics ----- 240, 242

Outside air temperature ----- 69

Overspeed protection, autopilot ----- 477

Overview ----- 1

P

Parallel Track ----- 215, 216

Passenger address ----- 128

PA system ----- 128

PIREP ----- 338

Pitch hold ----- 9

Pitch Hold Mode (PIT) ----- 436, 477

Pitch modes, flight director ----- 435–441

Pitch Reference ----- 436

Power-up page ----- 547

Power-up, system ----- 13

Presets ----- 543

Primary Flight Display (PFD)
Softkeys ----- 17–19

Procedure examples, AFCS ----- 461–468

Profile Path ----- 370

Profile View ----- 369

Q

Quick tuning 121.500 MHz ----- 102

R

Radio volume level ----- 111

RAIM ----- 234, 244, 245, 246

Range ----- 158

Receiver Autonomous Integrity Monitoring (RAIM) 2 7 – 2 8 , 244

Recorded data ----- 551

Register ----- 314

Required Vertical Speed ----- 264

Required Vertical Speed Indicator ----- 264

Reversionary display operation ----- 14

Reversionary mode ----- 131

ROC ----- 378, 388, 579, 580

Roll Hold Mode (ROL) ----- 431, 452

Roll modes, flight director ----- 451–454

Roll Reference ----- 452

RS-232 ----- 3

RS-485 ----- 3

Runway
Minimum length ----- 40
Surface ----- 40

RVSI ----- 264, 265

RX indicator ----- 101

S

SafeTaxi ----- 479, 493, 496

SafeTaxi® ----- 479

SafeTaxi database ----- 497

SBAS ----- 244, 245, 246, 571, 573, 597, 599

Scheduler ----- 479–480, 545

Secure Digital (SD) card ----- 12, 547, 583

Selected altitude ----- 53

Selected Altitude -----439, 442, 446, 462
 Selected Altitude Capture Mode-----439
 Selected Altitude Capture Mode (ALTS) ----- 438, 442
 Selected Altitude Intercept Arc----- 161
 Selected course-----49, 58
 Selected Course ----- 455, 457, 458
 Selected heading-----49, 58
 Selecting a COM radio ----- 100
 Selecting a NAV radio ----- 110
 Sequencing, automatic-----601
 Service class -----540
 Servos-----459
 SIGMET-----331
 SiriusXM
 radio-----278
 Radio-----539
 Receiver troubleshooting -----557
 XM WX Satellite Weather-----278
 Activating -----278
 NEXRAD-----288
 SiriusXM channel list-----541
 SiriusXM radio-----540
 SiriusXM radio entertainment-----129
 SiriusXM radio volume-----543
 SiriusXM Satellite Radio ----- 539, 541
 SiriusXM weather/radio-----4
 Slip/Skid indicator-----52
 Softkeys
 LTNG -----294
 PFD-----18–20
 Speaker-----125
 Standby frequency-----100, 103, 109
 Standby frequency field-----100
 Standby Navigation Database ----- 585, 587
 Stereo headsets -----125
 Stormscope -----359
 Stormscope lightning data ----- 22
 Stuck microphone-----131
 Sunrise-----241
 Sunset -----241
 SVS-----576
 SVS troubleshooting-----556
 Symbols, map-----605
 Synthetic vision (SVS) ----- 479, 480
 System annunciations-----17, 561, 563
 System Display (EIS) ----- 90–92
 System message advisories-----566
 System power-up ----- 13
 System Setup Page ----- 34
 System Status Page-----40
 System time-----35

T

TA -----566
 Tachometer ----- 83–85, 87–89, 91–93
 TAF-----297, 332
 TAS-----566, 574
 TAWS -----580
 TAWS-B
 System Status-----392
 Terminal procedures charts-----500, 520
 Terrain -----568
 Color indications -----607
 Terrain awareness and warning system (TAWS) ----- 75
 Terrain Proximity -----364
 Terrain-SVS-----372
 Timer-----575
 Departure-----42
 Flight-----42
 Timer, PFD generic-----41
 Time, system -----35
 TIS-----394
 TOD -----263, 264, 270
 TOPO DATA -----145, 146, 155
 Top of Descent -----263, 264
 TOPO SCALE-----147
 Track indicator-----57
 Traffic Advisory -----566
 Traffic annunciation-----49, 74
 Traffic information service (TIS)
 Voice alerts-----74
 Traffic Information Service (TIS)-----603–604
 Transponder code entry-----123
 Transponder data box-----95
 Transponder ground mode -----120
 Transponder softkeys-----120
 Transponder standby mode -----121
 Transponder VFR code -----124
 Trim adapter-----459
 Trip Planning-----240, 241, 242
 Trip statistics-----43
 Trip Statistics-----241, 242
 True airspeed -----50
 True Airspeed -----242
 Turbine Inlet Temperature (TIT) ----- 83, 85, 87, 89
 Turn anticipation -----601
 Turn rate indicator -----60
 TX indicator-----101

U

Unable to display chart ----- 500, 520
 Updating Garmin databases -----497
 Updating Jeppesen databases -----517

V

Vacuum Pressure-----84–85, 91–92
 VDI ----- 264, 265
 Vertical deviation -----444
 Vertical deviation guidance -----226
 Vertical Deviation Indicator -----264
 Vertical navigation-----225
 Direct-to -----224
 Vertical Navigation (VNV)
 Flight control----- 442–446
 Vertical Path Tracking Mode (VPTH) ----- 442–443, 467
 Vertical speed -----9
 Vertical speed guidance-----226
 Vertical speed indicator----- 55
 Vertical Speed Mode (VS)-----439
 Vertical Speed Reference -----439
 Vertical track-----566
 Video settings -----553
 Video system ----- 479, 552
 VNAV -----189
 VNV ----- 263, 576, 598
 VNV guidance
 Disabling -----223
 Enabling -----223
 VNV indications ----- 72
 VNV Target Altitude ----- 442–445
 VNV Target Altitude Capture Mode (ALTV) -----446
 Voice alerts, TIS----- 74
 Voice alerts, TIS Traffic----- 398, 421
 Voltmeter-----84–85, 91–92
 VOR
 Nearest ----- 181–182
 VOR selection-----109
 VS -----9
 VSI-----265
 Vspeed references ----- 49
 VS TGT----- 225, 263

W

WAAS-----247, 461, 598, 599
 WARNING-----562
 Waypoint
 Automatic sequencing -----601
 Skipping -----601
 Waypoint Pages (WPT)----- 31
 Waypoint Selection Submenu-- 186, 193, 197, 198, 244
 Weather (real-time)-----4
 Wind ----- 136, 157
 Wind data----- 49
 Winds Aloft -----334
 WIND Softkey----- 301, 334
 Wings level----- 450, 452

X

XM WX lightning-----18, 22
 XM WX Satellite Weather
 AIREPs -----308
 AIRMETs-----331
 Icing -----306
 PIREPs-----308
 SIGMETs-----331
 Turbulence----- 306, 307

Z

Zoom
 Auto-----138



GARMIN®

Garmin International, Inc.
1200 East 151st Street
Olathe, KS 66062, U.S.A.
p:913.397.8200
f:913.397.8282

Garmin AT, Inc.
2345 Turner Road SE
Salem, OR 97302, U.S.A.
p:503.391.3411
f:503.364.2138

Garmin (Europe) Ltd.
Liberty House, Bulls Copse Road
Houndsdown Business Park
Southampton, SO40 9RB, U.K.
p:44/0870.8501241
f:44/0870.8501251

Garmin Corporation
No. 68, Jangshu 2nd Road
Shijr, Taipei County, Taiwan
p:886/02.2642.9199
f:886/02.2642.9099

www.garmin.com

